

Perfect 16

Installation Manual



IQAir® Perfect 16™ ID-Series
MERV16 Micro-Particle Filtration System

Product Data

High-Performance Medical-Grade Residential/Commercial Air Filtration System

Application

The Perfect 16 ID Series is a V-bank filter system that connects to the return air duct or supply air duct of a forced air system. This Residential / Commercial Air Filtration System has been designed to provide the highest possible air cleaning rate at the lowest possible pressure drop for residential and commercial forced air systems. Two models are available. The ID-2225 is ideal for airflow rates up to 1200 cfm (2040 m³/h) and the ID-2530 for airflow rates up to 2000 cfm (3400 m³/h).

Features

- Ultra efficient: MERV16 certified (ASHRAE 52.2)
- Low air resistance: 0.22" w.c. (54 Pa) at rated airflow
- Long filter life: 3 years in average home use
- Quick and easy filter replacement: No tools needed
- Easy installation: Requires no electrical connections
- Rugged steel cabinet: Supports weight of furnace
- Medical grade finish: Powder coated galvanized steel
- Fully insulated for installation in unconditioned environments
- Swiss made quality: 10 year warranty

ID-2225: Provide 24 1/2 (622) service clearance in front of unit.
ID-2530: Provide 28 1/2 (721) service clearance in front of unit.

System All measurements in inch (mm)

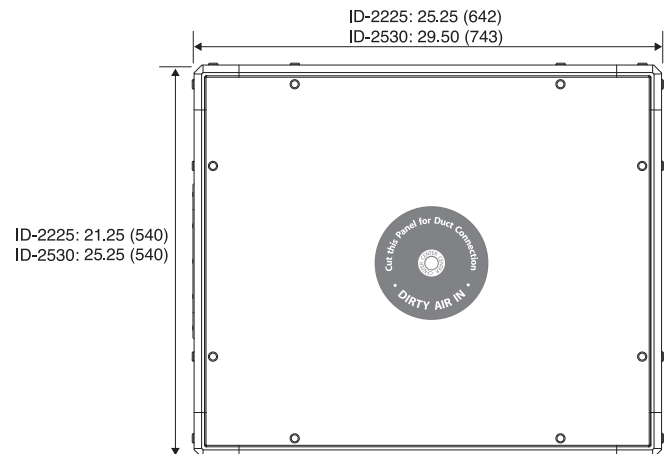
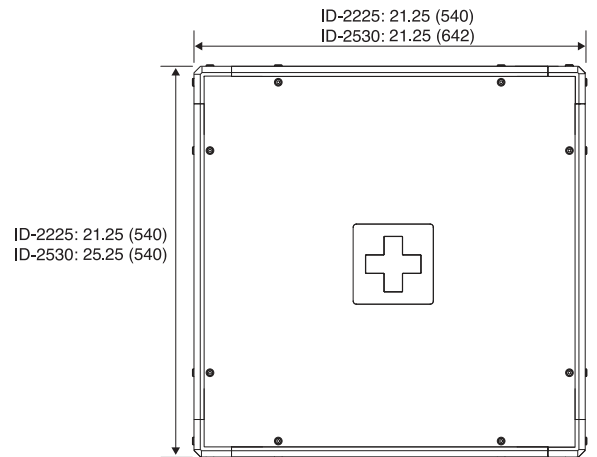
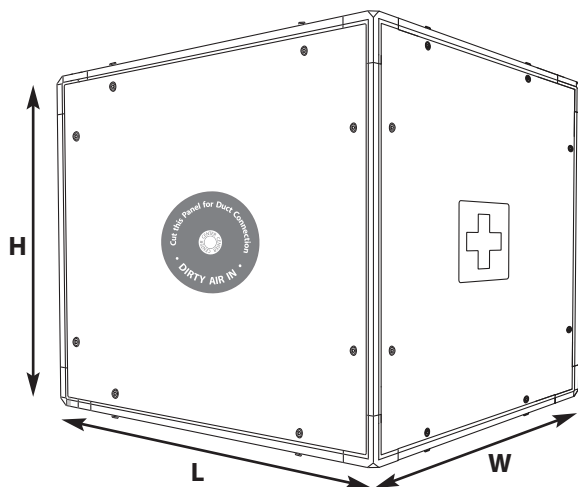

Performance Data

Usage vs. Resistance

Average home based on 50% duty cycle

Filter Usage	ID-2225 at 1200 cfm		ID-2530 at 2000 cfm	
	in H ₂ O	Pa	in H ₂ O	Pa
new	0.18	44	0.22	54
3 months	0.18	45	0.22	55
6 months	0.19	47	0.23	57
9 months	0.20	50	0.24	60
12 months	0.21	53	0.26	64
15 months	0.22	56	0.28	70
18 months	0.24	59	0.31	78
21 months	0.25	62	0.35	87
24 months	0.26	66	0.39	97
27 months	0.28	71	0.44	110
30 months	0.31	77	0.50	125
33 months	0.34	85	0.57	142
36 months	0.38	94	0.64	161

Resistance vs. Filter Use (50% Duty Cycle)

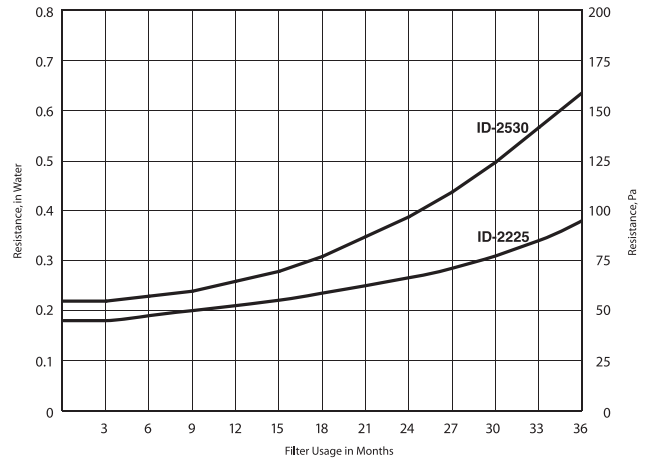

Minimum Efficiency Reporting Data

	ID-2225	ID-2530
Minimum Efficiency Reporting Value (MERV)	MERV 16@492 fpm (2.5m/s)	MERV 16@492 fpm (2.5 m/s)
Rated airflow	1400 cfm (2380 m ³ /h)	2000 cfm (3400 m ³ /h)
Composite Average Efficiency	E1 (0.3 – 1.0 μm) = 96.7% E2 (1.0 – 3.0 μm) = 97.7% E3 (3.0 – 10.0 μm) = 98.5%	E1 (0.3 – 1.0 μm) = 95.9% E2 (1.0 – 3.0 μm) = 97.3% E3 (3.0 – 10.0 μm) = 98.3%
Media area	170 sq.ft. (15.8 m ² /h)	210 sq.ft. (19.5 m ² /h)

Airflow vs. Filter System Resistance

cfm (m ³ /h)	ID-2225		ID-2530	
	in H ₂ O	Pa	in H ₂ O	Pa
600 (1020)	0.06	14	0.03	8
800 (1360)	0.09	21	0.04	12
1200 (2040)	0.18	44	0.10	24
1600 (2720)	0.33	82	0.15	38
2000 (3400)	0.49	122	0.22	54

Resistance of Filter System (Clean) vs. Airflow

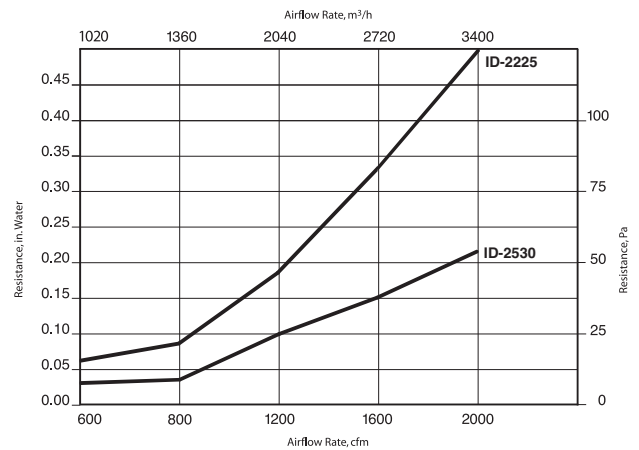

Based on ASHRAE 52.2 Air Cleaner Performance Reports from Intertek Testing Services (ETL SEMKO), Cortland, NY

Residential Installation

		ID-2225 System	ID-2530 System
Dimension L x W x H	inch	25.25 x 21.25 x 21.25	29.25 x 25.25 x 21.25
	mm	642 x 540 x 540	743 x 642 x 540
Weight		59 lbs. (27 kg)	74 lbs. (33.5 kg)
Order No.		207 80 21 02	207 80 21 04

		ID-2225 Replacement Filter Set	ID-2530 Replacement Filter Set
		SIZE 3	SIZE 4
Order No.		202 11 30 02 (Filter Set, 4 count)	202 11 30 03 (Filter Set, 4 count)

Residential Installation

The Perfect 16 ID-Series can be suspended from exposed ceiling joists or the ceiling surface. Alternatively, it can be floor-mounted (see page 5 for installation options).

1. Choose a location between the main return duct and the furnace, which is readily accessible for checking and replacing the filter. Allow at least 24.5 in. (622 mm) clearance in front of the ID-2225 and 28.5 in. (724 mm) clearance in front of the ID-2530.
2. Adapt connection panel for duct air handler connection as necessary (see page 4). Best performance is achieved with the 16" x 20" opening for the ID-2225 model, and the 20" x 25" opening for the ID-2530. If flex duct is used, it is strongly recommended to use 18" round dove tail collar for the ID-2225 and 20" for the ID-2530 for best performance.
3. Determine the correct air inlet and air outlet side of the system. The air inlet is marked with "Cut this Panel for Duct Connection - DIRTY AIR IN". The air outlet is marked with "Cut this Panel for Duct Connection - CLEAN AIR OUT". Both panels will need to be cut for the proper fit of the ducting prior to installation.
4. If the Perfect 16 system is to be located immediately alongside the furnace, remove filters and secure cabinet via panel from inside to the furnace with sheet metal screws. Ensure correct airflow direction when reinserting filters.
5. In basement installations, sheet metal turning vanes may be necessary to improve air movement through an elbow in the duct.
6. Use foil tape to seal all duct joints. Note: All leaks on the return side of the system will cause dirty air to leak into the return air stream. Leakage also occurs in many furnaces via the blower door. The blower door should also be sealed with foil tape for the best air cleaning results.
7. Fill out the filter replacement label with the date of the next scheduled filter replacement, which should be no later than 3 years from the current date (based on 50% usage).
8. Check and inspect system for leakage.
9. Test for efficiency with a ParticleScan.

Residential Installation Examples

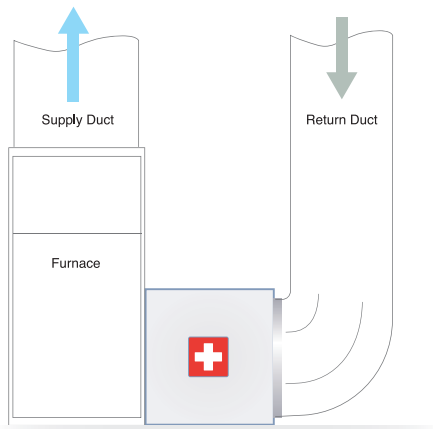

Up-Flow Furnace

Filter system is installed vertically and return air enters the furnace side inlet (up to 4 ton application).

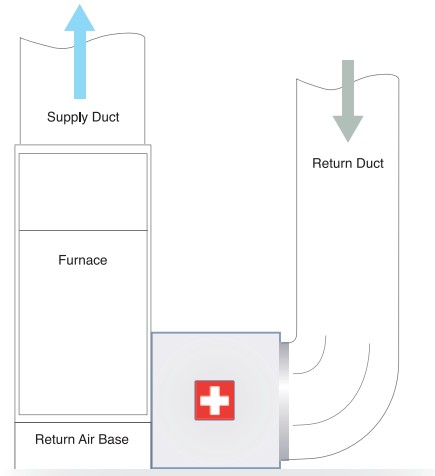

Up-Flow Furnace (5 ton application)

Filter system is installed vertically and return air enters the furnace side inlet (5 ton application).

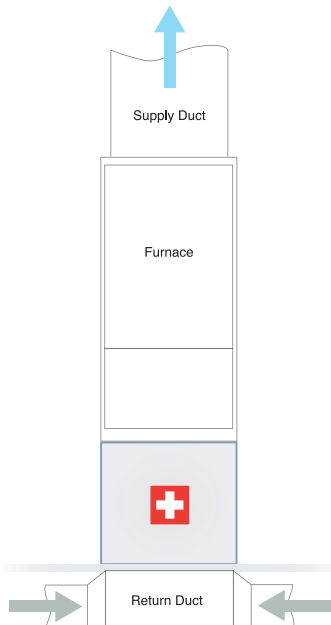

Up-Flow Furnace

Filter system is installed horizontally beneath the furnace. Return air enters from the bottom.

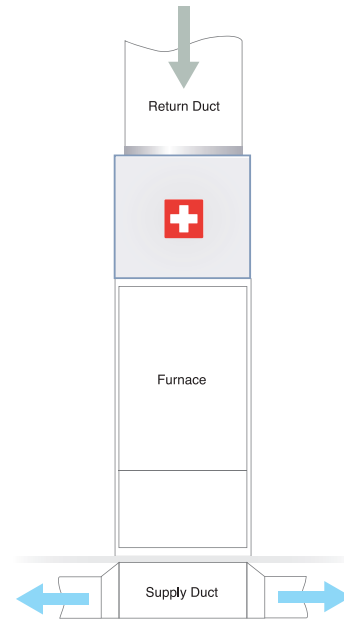

Down-Flow Furnace

Filter system is installed horizontally in the return air duct just above the furnace.

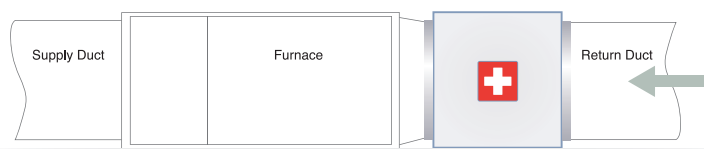

Horizontal Furnace

Filter system is installed vertically in the return air duct near the furnace.

Commercial Installation

		ID-2225 System	ID-2530 System
Dimension L x W x H	inch	25.25 x 21.25 x 21.25	29.25 x 25.25 x 21.25
	mm	642 x 540 x 540	743 x 642 x 540
Weight		59 lbs. (27 kg)	74 lbs. (33.5 kg)
Order No.		207 80 21 02	207 80 21 04

		ID-2225 Replacement Filter Set	ID-2530 Replacement Filter Set
		SIZE 3	SIZE 4
Order No.		202 11 30 02 (Filter Set, 4 count)	202 11 30 03 (Filter Set, 4 count)

Commercial Installation

The Perfect 16 ID-Series can be suspended from exposed ceiling joists or the ceiling surface. Alternatively, it can be floor-mounted.

1. Choose a location between the air handler and the supply registers, which is readily accessible for checking and replacing the filter. Allow at least 24.5 in. (622 mm) clearance in front of the ID-2225 and 28.5 in. (724 mm) clearance in front of the ID-2530.
2. Adapt connection panel for duct air handler connection as necessary (see page 4). Best performance is achieved with the 16" x 20" opening for the ID-2225 model, and the 20" x 25" opening for the ID-2530. If flex duct is used, it is strongly recommended to use 18" round dove tail collar for the ID-2225 and 20" for the ID-2530 for best performance.
3. Determine the correct air inlet and air outlet side of the system. The air inlet is marked with "Cut this Panel for Duct Connection – DIRTY AIR IN". The air outlet is marked with "Cut this Panel for Duct Connection – CLEAN AIR OUT". Both panels will need to be cut for the proper fit of the ducting prior to installation.
4. If the Perfect 16 system is to be located immediately alongside the air handler, remove filters and secure cabinet via panel from inside to the furnace with sheet metal screws. Ensure correct airflow direction when reinserting filters.
5. In basement installations, sheet metal turning vanes may be necessary to improve air movement through an elbow in the duct.
6. Use foil tape to seal all duct joints. Note: All leaks on the return side of the system will cause dirty air to leak into the return air stream. Leakage also occurs in many air handlers via the blower door. The blower door should also be sealed with foil tape for the best air cleaning results.
7. Fill out the filter replacement label with the date of the next scheduled filter replacement, which should be no later than 3 years from the current date (based on 50% usage).
8. Check and inspect system for leakage.
9. Test for efficiency with a ParticleScan.

Commercial Installation Examples



Supply Duct

The Perfect 16 can be installed on supply ducts, provided the airflow of the duct is 2000 cfm or less. Balance volume dampers and/or registers as necessary.

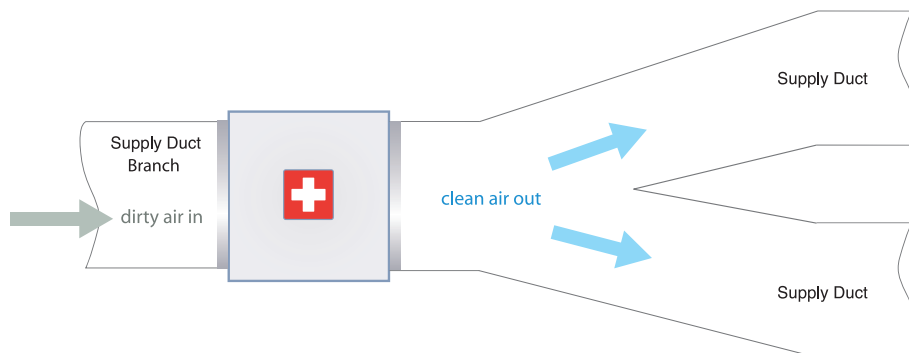

Supply Duct Branch

The Perfect 16 can be installed on supply duct branches, provided the airflow to the branch is 2000 cfm or less. Balance volume dampers and/or registers as necessary.

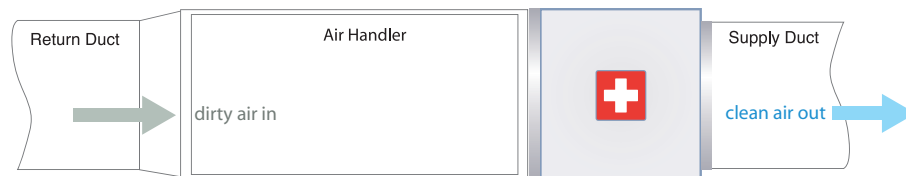

Before Supply Plenum

In installations of 2000 cfm (5 tons) or less, the Perfect 16 can be installed before the Supply Plenum. Note: The Perfect 16 is designed to sustain a maximum of 149°F (65°C).

Cutting Openings into Panels



1. Remove the panel with sticker "please cut here for duct connection" from the Perfect 16 system. Detach the insulation from the panel.

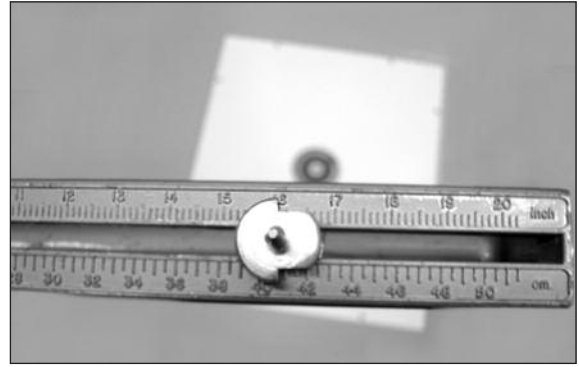

2. Adjust the cutting tool to the right position and fix it in the center hole of the panel for any round opening.



3. Cut the panel and remove the inner part.

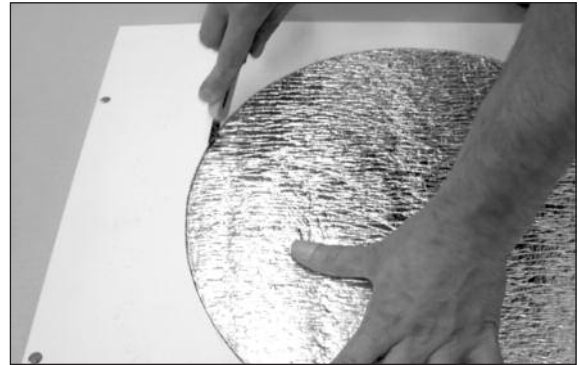

4. Put the insulation under the panel and cut it around the opening.

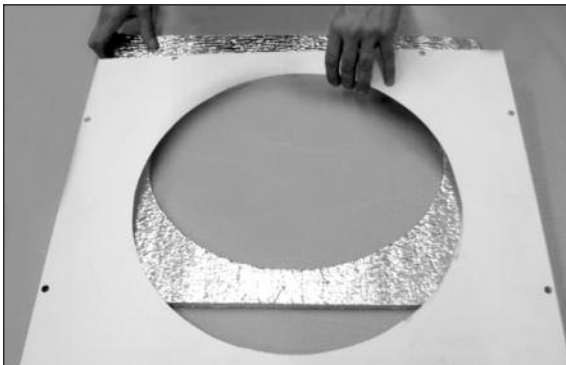

5. Remove the insulation again.

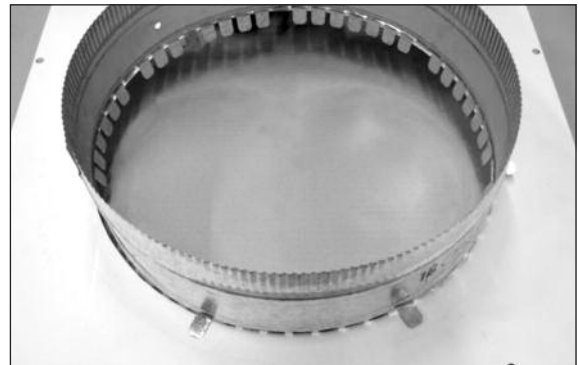

6. Install the dove tail collar on the panel by folding some "teeth" to the outer side for fixing the collar on the panel.

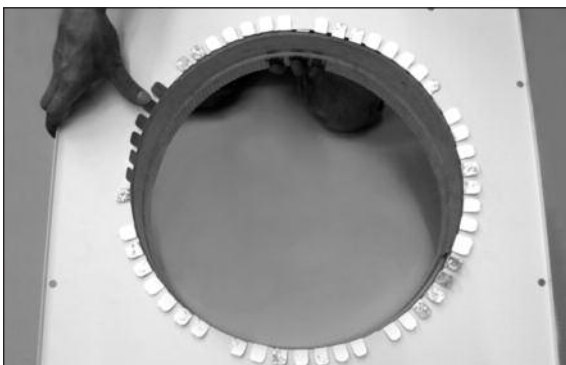

7. Turn the panel around and fix the collar by folding the rest of the "teeth".

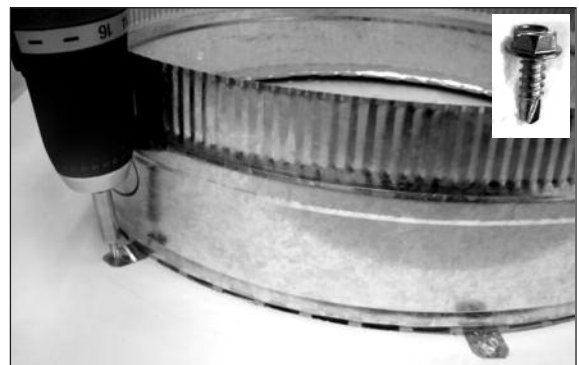

8. Screw the collar tightly on the front side by fixing the "teeth" with metal screws.

Cutting Openings into Panels



9. Seal the gap between the collar and the panel and wait till it has dried.



10. Put the insulation to the inner side of the panel and fix the insulation to the collar with a duct tape.



11. Stick the tape tightly to the insulation.

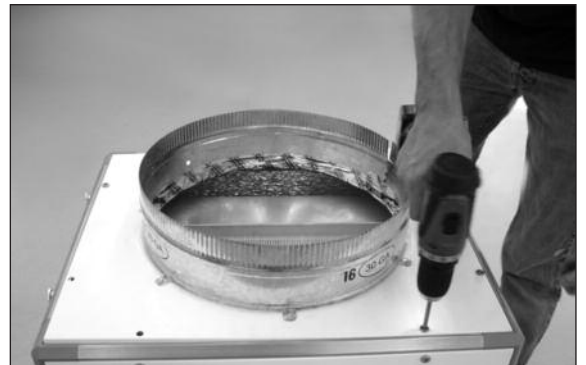

12. Attach the connection panel again to the Perfect 16 system.

Installing the Perfect 16

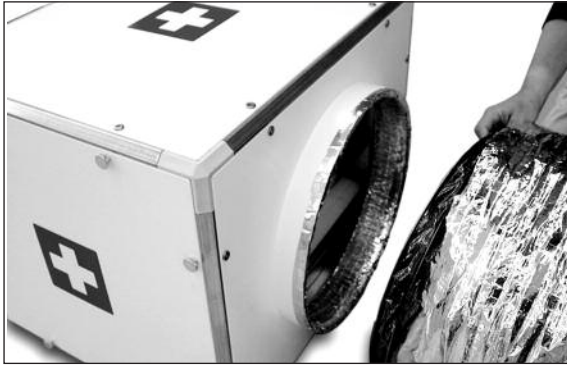

1. When positioning the unit, ensure that "Dirty Air In" is your air inlet. For duct connection, follow local installation codes.



2a. To attach the Perfect 16 directly to a furnace, take out all filters and use sheet metal screws to tap through square connection panel.

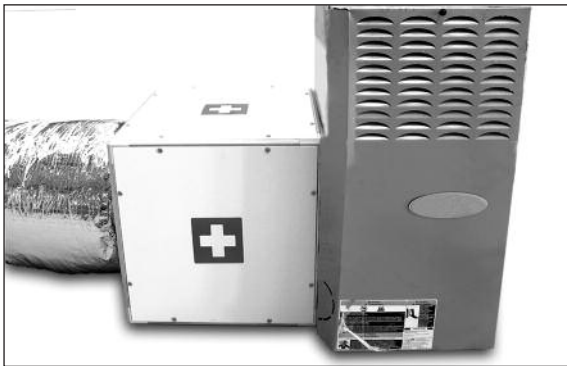

2b. Side connection as pictured can be used for up to 4 ton applications. For 5 ton applications use return base.



3. Ensure that there is unobstructed access to the filter replacement door. Ensure 24 ½ in. (622 mm) front clearance for unit ID-2225 and 28 ½ in. (724 mm) for ID-2530.



4. To hang or suspend the Perfect 16, replace four TX30 screws with four Perfect 16 eye bolts. These are available for a nominal fee.

Filter Replacement



1. Access to replace filters is gained from the side panel with the finger screws attached to it.



2. Remove all eight finger screws.



3. Remove access panel.

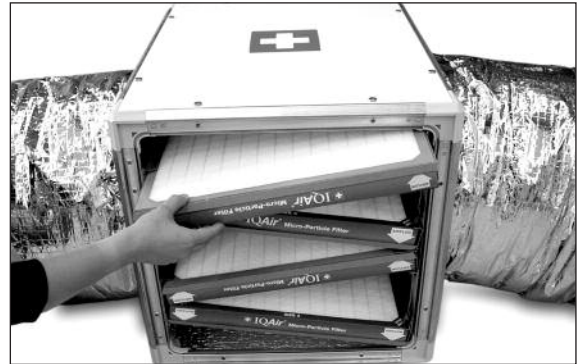

4. Remove filters starting from the top.



5. Insert new filters starting from the bottom.



6. Ensure that you align the filters with the airflow arrows matching the airflow arrows on the cabinet.



7. Double check that all filters have been inserted correctly and replace access panel with screws.



8. Fill out filter replacement label with scheduled date of next filter replacement. This should be no later than 3 years from current date, and affix on outer panel.

Perfect 16 Warranty & Support

Limited Parts Warranty Conditions

We are proud to cover the Perfect 16 air cleaning system with a ten (10) year limited warranty. Within 10 years from the original purchase date by the end-user from the authorized IQAir Dealer/Installer if this appliance or any part thereof (with the exception of filters) is proved to be defective by reason only of faulty workmanship or materials, IQAir North America, Inc. will at their option repair or replace the faulty appliance or part free of charge. This warranty is for parts and does not include labor. The warranty for replaced parts will automatically expire with the termination of the original device's warranty.

This warranty shall not apply to damage caused by misuse, wear and tear, neglect, unauthorized repair, damage caused by installation, adaptation, modification or use in an improper manner or inconsistent with IQAir's operating and maintenance instructions, or to wear or deterioration resulting from environmental conditions or to damage sustained during transit. IQAir North America, Inc. will not be liable under this warranty for any fault or damage arising from defective workmanship.

IQAir North America, Inc. will not refund shipping, handling or insurance costs for warranty repairs. Obvious defects must be communicated to the authorized IQAir Dealer/Installer within 10 days of the purchase date. To secure your warranty rights and prevent possible transport damage, all products must be returned in original IQAir packaging. Please keep the original packaging.

Alternatively, original IQAir packaging can be ordered from IQAir North America, Inc.

IMPORTANT NOTE: All products you wish to return for service or repair must be accompanied with a Return Authorization Number (RA Number). This number can be obtained by contacting the IQAir Technical Support Team. The RA Number must be clearly visible on all external packaging. IQAir North America Inc. reserves the right to refuse any shipment received without RA Number and to return the shipment at the original sender's cost.

IQAir's Technical Support Team

Should technical questions arise before, during or after installation, please contact the IQAir Technical Support Team. You may contact the IQAir Technical Support Team at:

IQAir North America, Inc.
14351 Firestone Blvd
La Mirada, CA 90638
Phone: 562-236-1199
Fax: 562-903-7601
e-mail: support@iqair.com

Toll-free: 888-560-1020

To expedite your service, please have the following information ready when contacting us:

- IQAir model
- Shell number
- Serial number (found on the base of the unit)
- Your details (name, address, phone, e-mail)
- Date of purchase
- Description of problem

Thank you for choosing IQAir.