



Residential Air Purification Systems



The IQAir® Difference

You are what you breathe.

It's time to get serious about air quality.

You eat 3-5 nutritious meals a day. You try to drink 8 glasses of pure water a day. You obviously care about your health. But what do you do to make sure that the 30,000 breaths you take every day truly revitalize your body? It may not be possible to control the air everywhere. However, our passion at IQAir is to help you control the air in the most important environment – your home. We deliver air purification products that can make a *real* difference. While other companies may focus on profits, we are truly passionate about delivering the very best air quality products in the world.

Not all purifiers are created equal.

Other manufacturers make unsubstantiated claims and offer little more than slogans. In fact, most HEPA air cleaners are advertised to be 99.97% efficient. That may sound impressive, but their claims are based on the *theoretical* efficiency of their filter material, not on the actual clean air coming out of the air purifier. That's where IQAir is different. While other air purifiers often fail to meet even 10% of their label claims, IQAir combines the very best air filtration technology in the world with superior design to deliver pure, clean air that meets or exceeds our claims. And we guarantee the results in writing.

Welcome to the IQAir revolution.

*We look beyond theoretical claims and test each individual system for **Total System Efficiency** – the actual air coming out of the system. The results are detailed in a hand-signed certificate of performance included with each and every IQAir system.*



Our passion is air cleaning excellence.

For more than 50 years, IQAir has remained at the cutting edge of indoor air purification.

We lead, others follow. In 1963, IQAir introduced the first home air cleaning system and started an industry that we continue to lead today. Our Swiss-based design and manufacturing team produced the first home air purifiers capable of achieving a “0” reading (no particles coming out of the air outlet) using sophisticated laser particle counters.

Extraordinary commitment and dedication.

In addition to extraordinary research, development and design, IQAir is committed to reaching new levels of manufacturing precision and excellence. We manufacture all IQAir systems in our own state-of-the-art production facility in Switzerland. By using the highest quality components, a dedicated team of skilled craftspeople, and state-of-the-art manufacturing processes, we continue to build the best value and highest quality air cleaning products in the world.

From our family to yours.

IQAir Founder Klaus Hammes (who started the business with his brother Manfred), can still be found on the production line inspecting air cleaners. From our family to yours, IQAir’s Swiss quality assurance provides you with the very best air cleaner you’ll ever own.



Look closely and see why IQAir® is the smartest choice.

Only IQAir delivers unrivaled performance and superior value.

Cost effective, and they keep delivering.

IQAir systems are more powerful than any other air purifiers around, yet they are energy efficient and cost effective. While less expensive air filters only last weeks or months, our HyperHEPA® filters last up to four years under normal conditions. While other air purifiers begin to lose their effectiveness the moment you turn them on, our systems actually retain or increase effectiveness over time. And our room air purifiers feature a sophisticated control panel that alerts you when it's time to change filters, and not a moment earlier.

All of the good, none of the bad.

IQAir air purifiers feature the safest, healthiest and most effective way to clean the air. Our industry-leading technology is recommended by government agencies and leading health organizations. IQAir systems produce no ozone, ions, chemicals, UV or any other dangerous byproducts. We never take chances with your family's health, and we always provide superior technology and value. That is why IQAir is the smartest choice.

When it comes to performance, value and reliability, the only decision you have to make is selecting the right IQAir system for your needs.

Best All-Around Room Air Purifier

Rated #1 for allergies, asthma and indoor pollution control.

New Edition
HealthPro® Series
Page 5



Best Gas-Phase Room Air Purifier

Rated #1 for MCS, chemicals, odors and tobacco smoke.

New Edition
GC™ MultiGas
Page 9



 **AllergyBuyersClub**
Category Winner
★★★★★
Excellent

Best All-Around Whole-House System

Rated #1 for allergies, asthma and whole-house pollution control.

Perfect 16®
Page 13



HealthPro® Series

The New Edition HealthPro Series.

The best air purifiers just got even better.

The IQAir® HealthPro has received more top reviews and awards than any other air purifier. It is the #1 choice for asthma and allergy sufferers. At the heart of this revolutionary system is the exclusive IQAir HyperHEPA® filtration technology. A dense network of nano-fibers effectively traps particles of all sizes. That includes viruses, pet dander, dust mites, other allergens and even cigarette smoke.

Stop even the smallest airborne allergens.

Experts agree that the best way to avoid allergy and asthma symptoms is to reduce your exposure to allergens and other airborne irritants. This is where the IQAir HealthPro Series excels. While ordinary air cleaners are only tested for the largest 10% of particles, IQAir's HyperHEPA filtration is tested and certified to filter 99.5% of all particles down to 0.003 microns. These are the smallest particles that exist. Imagine the difference virtually allergen-free air can make to your health. What's the point of owning an air purifier unless it can help protect you against the most harmful particles in the air?

The IQAir HealthPro Plus has revolutionized the air purifier industry. Its innovative design stops system leakage and makes it the first air purifier capable of achieving a "0" particle count. This means no particles can escape IQAir's HyperHEPA filtration technology.

Conquer airborne pollutants.

Three unique HealthPro models designed to match your needs.

New Edition

HealthPro® Plus

Recommended for asthma, allergies and indoor air pollution.

New Edition

HealthPro®

Recommended for allergies and indoor air pollution.

New Edition

HealthPro® Compact

Recommended for allergies and indoor air pollution.



Includes V5-Cell™ gas & odor filter.

Does not include V5-Cell gas & odor filter. However, can be upgraded to V5-Cell.

Does not include V5-Cell gas & odor filter. Cannot be upgraded to V5-Cell.

New Edition: Up to 25% more clean air, 32% less noise and up to 38% longer filter life.

IQAir's best-selling air purifier.

The quietest high performance air purifier in the world.

The revolutionary IQAir® HealthPro Plus is designed with a four-stage filtration process that cleans the full spectrum of airborne pollutants.

How it works

① PreMax™ Pre-Filter

Air is drawn in at the bottom of the system and into the pre-filter. The PreMax pre-filter eliminates coarse and fine particles such as pollen, pet dander and mold spores.

②③ V5-Cell™ Advanced Gas & Odor Control

The two-stage V5-Cell gas & odor filter uses dual media to filter a wider spectrum of volatile organic compounds (the cause of odors) and other harmful chemical vapors. Granular activated carbon adsorption and pelletized chemisorption work together to go beyond conventional activated carbon filters found in ordinary air purifiers.

④ HyperHEPA® Filter

The unequalled IQAir HyperHEPA filter eliminates fine and ultrafine particles, including bacteria, viruses and highway exhaust particles. The clean air is then expelled through the EvenFlow™ diffuser and distributed throughout the room.

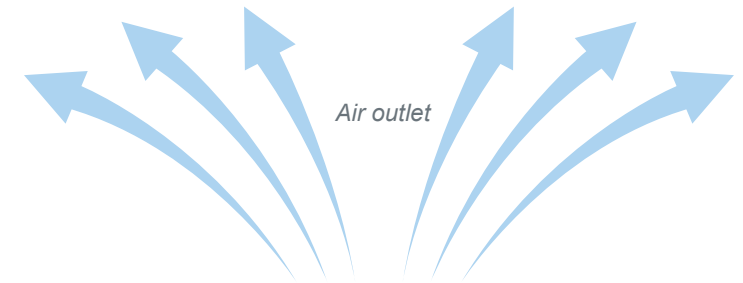

④

②③

①



- = Dust, pollen, pet dander and mold spores
- = Volatile organic compounds and other harmful chemicals
- = Ultrafine particles such as bacteria, viruses and combustion particles

HealthPro® Plus Advanced Features

Sophisticated Controls

Easy-to-program controls help you cut energy costs and extend filter life.

EvenFlow™ Diffuser

320-degree air delivery means more air is delivered in more directions, so there is minimal sound and no drafts.

3D UltraSeal™

Patented triple-sealing technology uses knife-edge-in-groove design to eliminate leakage and ensure that all the air is passed through the HealthPro system.

Mobility

The HealthPro is ready to move whenever and wherever you need it.

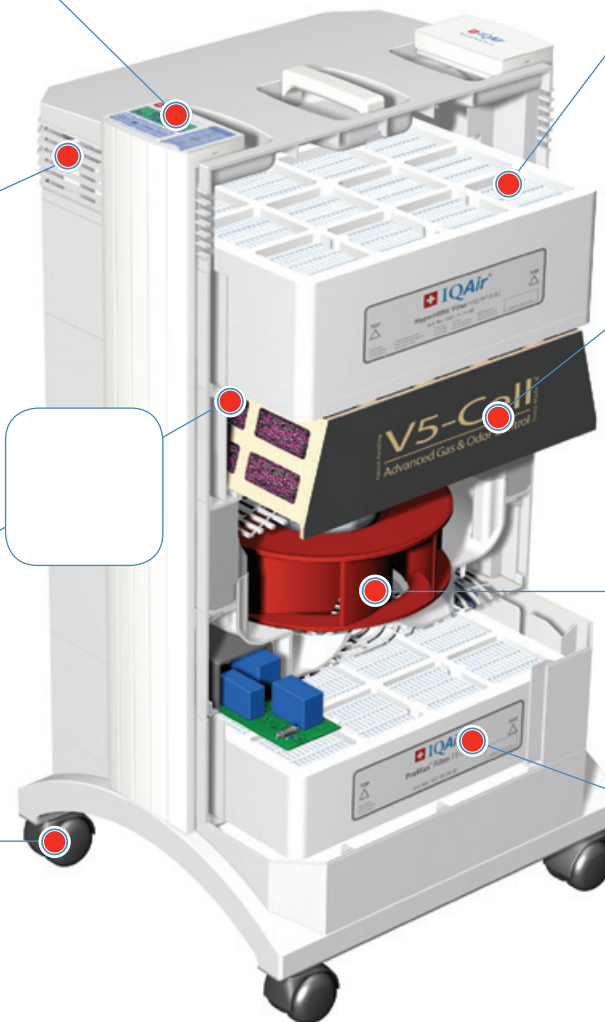

HyperHEPA® Filter

Proven protection against particles of all sizes, including ultrafine particles. New Edition features the most advanced filter-pleating pattern ever designed for a residential system – increasing airflow and extending filter life by 38%.

V5-Cell™ Gas & Odor Filter

Protects against chemicals, odors and gases in the air with dual-media wide-spectrum filtration. Our system combines two types of media: one that adsorbs odors and gases and another that changes the pollutant to an oxidized form.

New Edition Fan

The new three-dimensionally optimized design now uses state-of-the-art aerodynamics to convert energy into more air and less noise.

PreMax™ Pre-Filter

After air is drawn in through the air intake, the PreMax pre-filter eliminates micro-particles such as pollen, pet dander and mold spores. New Edition technology extends the life of the PreMax pre-filter by 20%.



GC™ MultiGas

The New Edition GC MultiGas.

Rated #1 for multiple chemical sensitivity and smoke.

The GC MultiGas is the #1 rated air purifier for those with multiple chemical sensitivity (MCS). Its four gas filter cartridges put the highest-quality granulated carbon and alumina pellets impregnated with potassium permanganate to work for you against gases, odors, chemicals and even smoke. And the GC MultiGas HyperHEPA® filtration technology delivers a minimum Total System Efficiency of 99% for particles 0.3 microns and larger and 95% for ultrafine particles down to 0.003 microns.

One system gives you the best of both worlds.

Some air purifiers claim to be effective against gases. Others claim to be effective against particles. But the IQAir® GC MultiGas integrates the best of both technologies together into a single system that provides superior filtration of gases *and* particles. The GC MultiGas features the most advanced gas controlling system ever designed. Combined with powerful particle filtration, this system can help you live a normal, healthy life again. Isn't it time you took control over your chemical sensitivities?

Safe technology and materials make it even better.

The GC MultiGas offers medical-grade air filtration without unhealthy or unproven technologies such as ozone generation, ionization, ultraviolet radiation or chemicals. And because the GC MultiGas components include the highest quality, non-off-gassing ABS plastics, you can count on years of the highest performance and reliability.

Advanced chemical filtration for your home.

The GC MultiGas goes even further to help protect you against gases.



New Edition: Up to 21% more clean air, 32% less noise and up to 20% longer filter life.

Best filter media, superior design.

The IQAir® GC MultiGas has no equal.

The GC MultiGas combines the best filter media in the industry with superior IQAir design to provide an unequalled level of protection against gases, odors, chemicals and particles.

How it works

① H11 HyperHEPA® Pre-Filter

The powerful HyperHEPA pre-filter eliminates allergens, smoke, bacteria and viruses. The pre-filter also helps extend the life of the gas-phase media by preventing the gas control cartridges from clogging with particulates.

②③ MultiGas Filter Cartridges

Cartridge-based activated carbon adsorption: Eliminates volatile organic compounds (VOCs), which are responsible for odors. Cartridge-based chemisorption: Destroys harmful chemicals, such as formaldehyde, by an oxidation process inside a chemically active alumina pellet.

④ Post-Filter Sleeves

The micro-charged post-filter sleeves prevent any media dust from being released while further improving overall system efficiency. Then only the cleanest air passes through the EvenFlow™ diffuser and throughout your home.

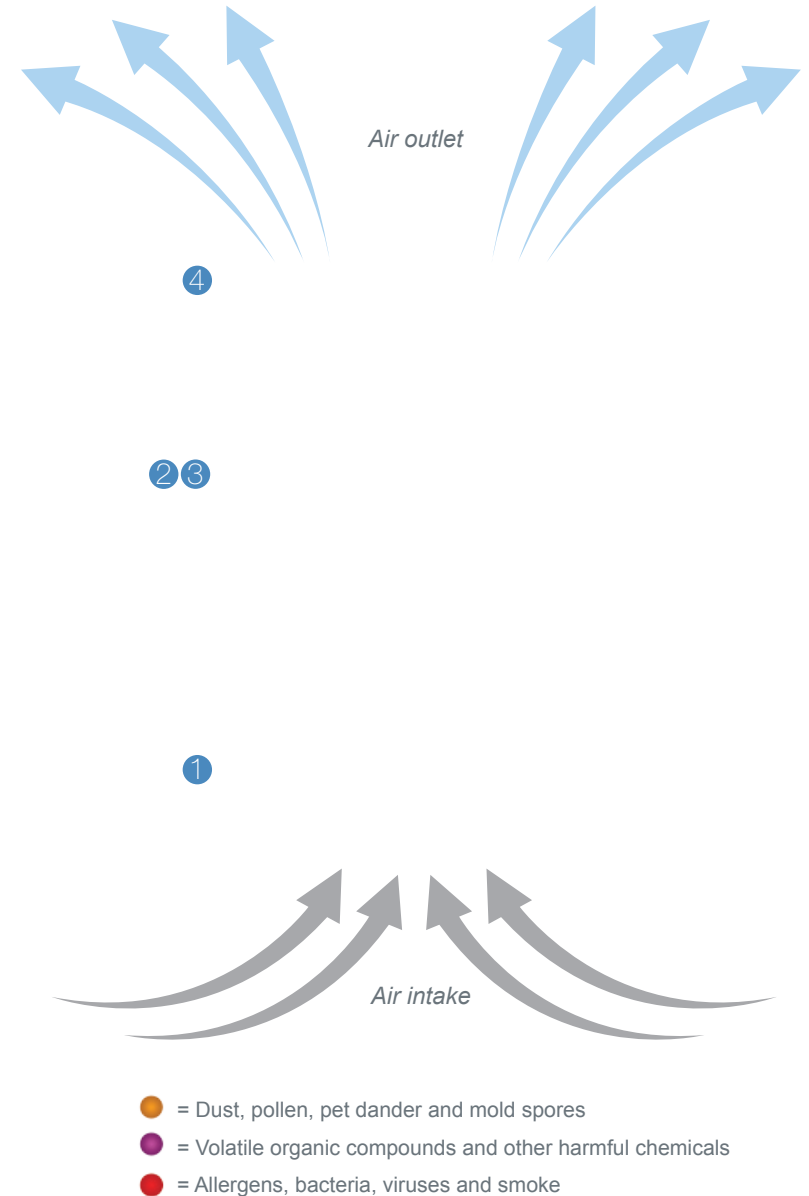

GC™ MultiGas Advanced Features

Sophisticated Controls

Easy-to-program controls help you cut energy costs and extend filter life.

EvenFlow™ Diffuser

320-degree air delivery means more air is delivered in more directions, so there is little sound and no drafts.

3D UltraSeal™

Patented triple-sealing technology uses knife-edge-in-groove design to eliminate leakage and ensure that all the air is passed through the GC MultiGas system.

Mobility

The GC MultiGas is ready to move whenever and wherever you need it.

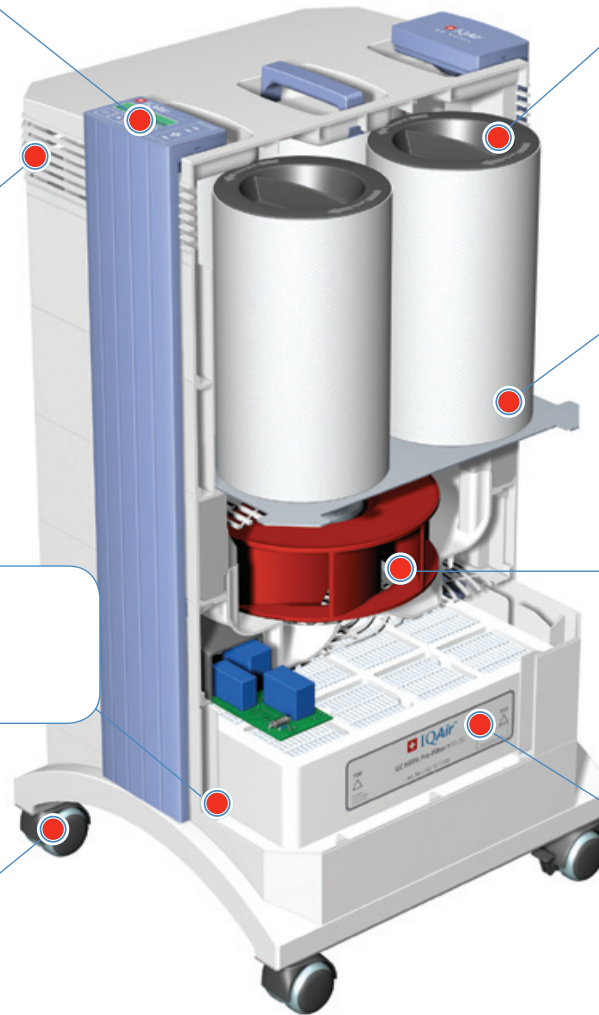

MultiGas Filter Cartridges

The superior technology of four gas-phase filters contains 12 pounds (5.4 kg) of activated bituminous-coal carbon and alumina pellets to clear the air of gases, chemicals and odors.

Post-Filter Sleeves

Post-filter sleeves wrap each gas cartridge to prevent media dust from being released while also improving efficiency.

New Edition Fan

The new three-dimensionally optimized design now uses state-of-the-art aerodynamics to convert energy into more air and less noise.

H11 HyperHEPA® Pre-Filter

Certified H11 HyperHEPA pre-filter eliminates micro- and nano-particles such as allergens, smoke, bacteria and viruses, helping to protect and extend gas-phase cartridge life. New Edition technology extends the life of the H11 HyperHEPA pre-filter by 20%.

Perfect 16®

Create a clean air sanctuary.

Rated #1 for whole-house pollution control.

Whole-house allergen and particle control.

The Perfect 16 can transform your entire home into a safe haven from airborne allergy and asthma triggers and other airborne pollutants. It continuously filters all of the air in your home with advanced micro-fiber technology that filters dust, pollen, mold spores, viruses and other particulate contaminants, including ultrafine particles. Rated a perfect MERV 16 according to ASHRAE 52.2 industry standards, the Perfect 16 delivers medical-grade clean air continuously and automatically throughout your home without impeding the airflow of your central heating and air conditioning system.

Rated #1 whole-house system, industry-leading guarantee.

Every Perfect 16 system comes with expert installation by IQAir® certified installers who love to create clean-air sanctuaries. They are trained to install the Perfect 16 seamlessly into your existing HVAC system. After installation, your installer tests and certifies your Perfect 16. We promise and deliver more than a 90% reduction of airborne allergens, or your money back. We certify that your system is delivering air free of more than 90% of all particles 0.3 microns or larger. What's more, the Perfect 16 is proven to filter more than 85% of all particles down to 0.003 microns, the smallest particles that exist. With the Perfect 16, you will live in one of the healthiest homes in America.



The ultimate whole-house air purifier.

Turn your house into one of America's healthiest homes.

- 10X cleaner air guarantee
- Ultra-low air resistance
- Filters last up to 3 years

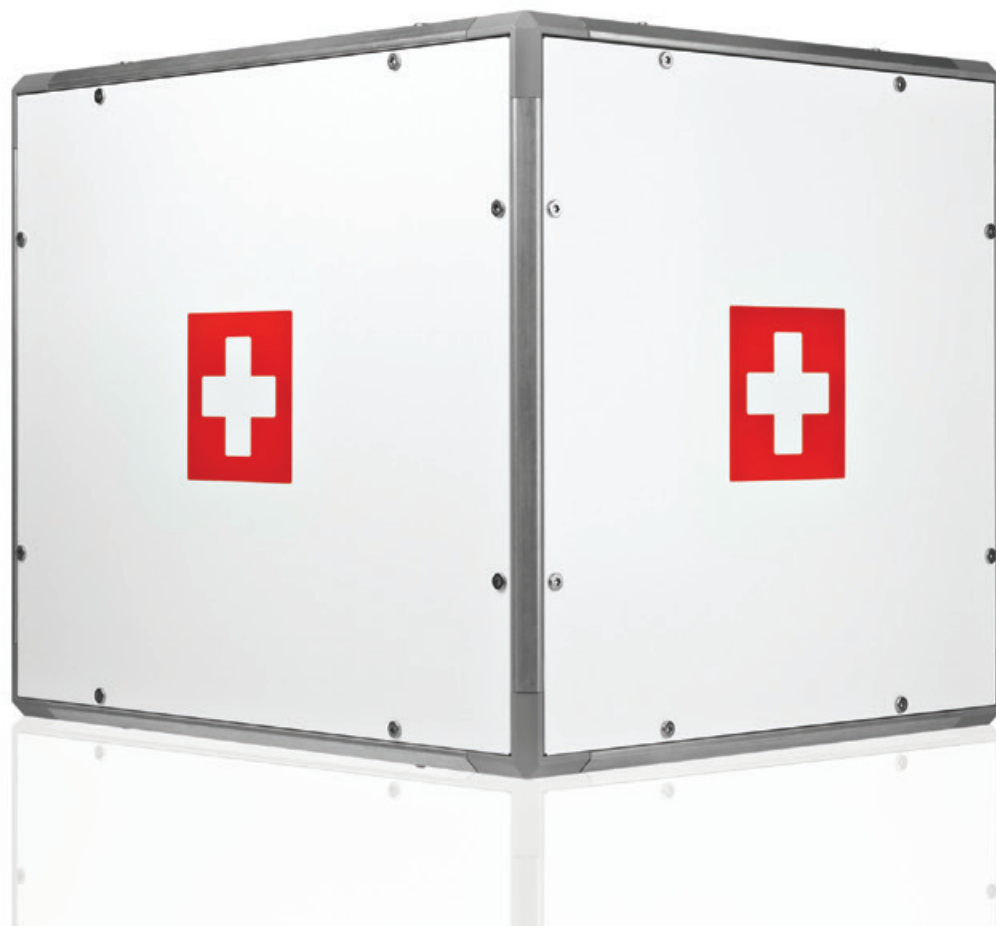

Efficient, effective, silent – perfect.

It can even save you money on energy costs.

The IQAir[®] Perfect 16 whole-house air purifier works with your existing heating and cooling system to turn your entire house into a clean-air haven. With no moving parts and no electricity usage, the Perfect 16 with its V2 filtration design is a stunning marvel of modern engineering. It attains a MERV 16 rating, the highest filtration rating possible. And it's absolutely silent.

Efficient filtration, airflow, energy usage.

The Perfect 16 can actually improve the efficiency of your heating and cooling system, and it can lower your energy bills. The system creates virtually no pressure drop. All of this is accomplished without adding anything unhealthy into the air such as ions, ozone, UV or chemicals used by other systems. And Perfect 16 filters last up to three years under normal usage.

Advanced technology, easy installation.

The Perfect 16 pairs advanced technology with innovative design to produce a level of performance never before seen in a whole-house air purifier. Our trained experts install the system for you, so there is nothing for you to do but enjoy the clean, healthy, pure air in every room. Automatic, silent, efficient. Experience perfection in air purification with the IQAir Perfect 16.

AMF[™] Filtration Technology is nearly impenetrable.

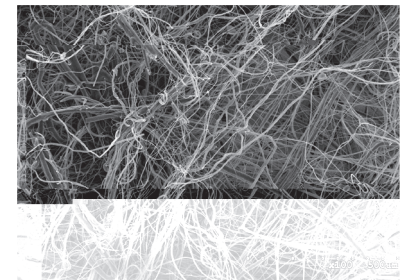

The Perfect 16 uses Advanced Micro-Fiber (AMF) filtration technology. AMF fibers are 10 times thinner than conventional filter fibers. This allows air to easily pass through the filters, while the ultrafine threads create an almost impenetrable barrier for pollutants.

How it works

The Perfect 16 whole-house air purifier is seamlessly retrofitted into your home's existing heating and/or air conditioning system. It silently and efficiently cleans all of the air in your home up to 125 times per day.

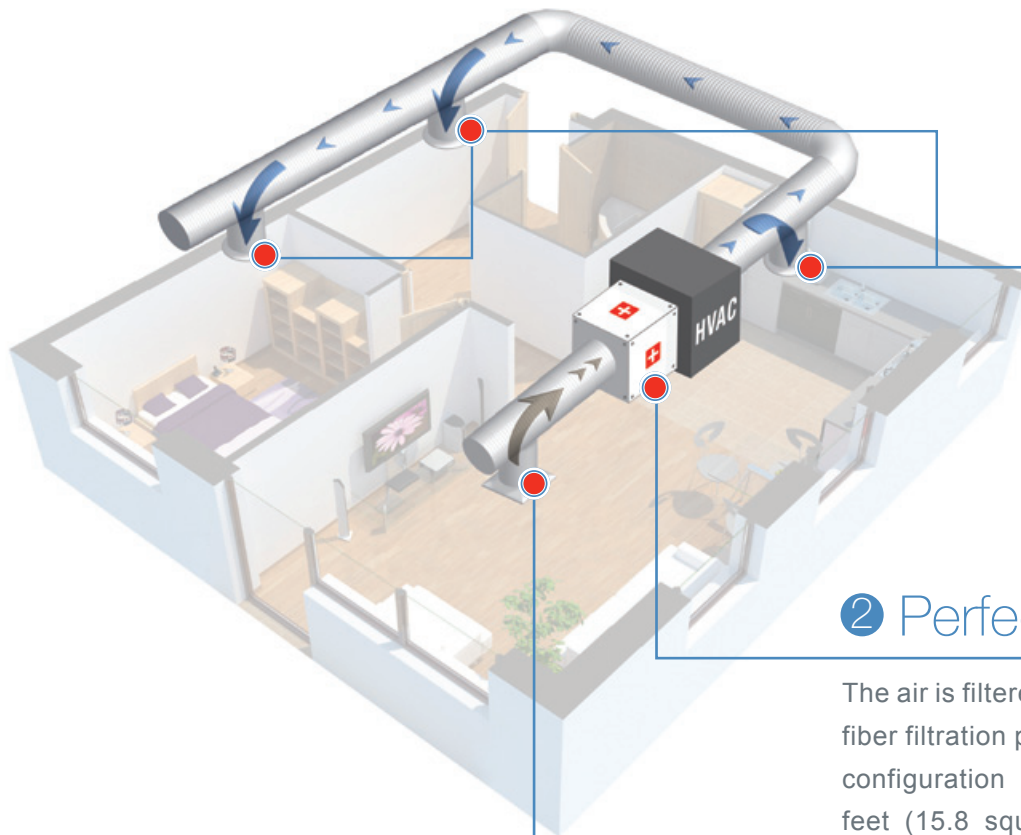

1 Air intake

Air is drawn through your home's return grill, typically located in a common area such as a hallway or living room.

2 Perfect 16 filtration

The air is filtered through four pleated micro-fiber filtration panels arranged in a double-V configuration with more than 170 square feet (15.8 square meters) of filter media. This allows the Perfect 16 to deliver up to *50 times more filtration power* than ordinary filtration systems.

V2 design

3 Clean air delivery

Clean air is passed through your heating and cooling system and supplied back into your home.

Judge us by the company we keep.

#1 in awards and reviews.

Our air purifiers have received more awards than any other, with #1 ratings from Consumers Digest, ConsumerSearch, Parent Tested/Parent Approved, Reviewboard Magazine, Allergy Buyers Club and many more. And whenever the popular ABC television show “Extreme Makeover: Home Edition” needs to create an ultra-clean home for a deserving family with health concerns, they turn to the world’s leader in advanced air cleaning solutions: IQAir®.

#1 Choice for critical applications.

IQAir is the #1 choice of hospitals worldwide. In fact, the Hong Kong Hospital Authority chose IQAir to help fight the spread of the SARS virus. IQAir is also the #1 choice of athletes, and was chosen by the U.S. Olympic Committee to clean the air for its athletes in Beijing. And when wildfires strike, IQAir supports the American Red Cross with air purifiers to protect hospitals, emergency rooms and evacuation shelters.

Partners in promoting air quality.

IQAir collaborates with leading organizations and partners who share our passion for making the world a better place. That’s why we were selected by the American Lung Association as their exclusive partner for the air cleaning industry. We also support the indoor air quality efforts of a number of organizations such as the U.S. Green Building Council.

IQAir Success Story

Because of her asthma and allergy symptoms, Niagara University ice hockey sensation Erica Owczarczak was ready to give up the game after her sophomore year. Then a friend introduced her to the IQAir HealthPro® Plus. “What a difference,” she says. “I was able to breathe like a normal person.” When Erica returned to the ice for her junior season, her coaches were amazed at her recovery, and she went on to become a top Division I player and team captain. “I wouldn’t have been able to do that without the HealthPro Plus,” she says.

Read more success stories at www.iqair.com/success.





Assisting people in living longer, healthier lives by providing the very best air quality products in the world.

IQAir North America, Inc.

www.iqair.com

 888-400-5070

 800-610-1Air(247)

Contact your IQAir Authorized Dealer today: