



American Property Inspections of Texas



Phone: 281-744-3965

Email: RScarborough@APITX.net

www.apitx.net

PROPERTY INSPECTION REPORT

Prepared For: Ken & Liu Lo

Concerning: 10815 Lake Raven Ct. Cypress, TX. 77433

Inspected By: Rod Scarborough TREC License # 7189 May 28, 2021

PURPOSE, LIMITATIONS AND INSPECTOR / CLIENT RESPONSIBILITIES

This property inspection report may include an inspection agreement (contract), addenda, and other information related to property conditions. If any item or comment is unclear, you should ask the inspector to clarify the findings. It is important that you carefully read ALL of this information.

This inspection is subject to the rules ("Rules") of the Texas Real Estate Commission ("TREC"), which can be found at www.trec.texas.gov.

The TREC Standards of Practice (Sections 535.227-535.233 of the Rules) are the minimum standards for inspections by TREC licensed inspectors. An inspection addresses only those components and conditions that are present, visible, and accessible at the time of the inspection. While there may be other parts, components or systems present, only those items specifically noted as being inspected were inspected. The inspector is NOT required to turn on decommissioned equipment, systems, utility services or apply an open flame or light a pilot to operate any appliance. The inspector is NOT required to climb over obstacles, move furnishings or stored items. The inspection report may address issues that are code-based or may refer to a particular code; however, this is NOT a code compliance inspection and does NOT verify compliance with manufacturer's installation instructions. The inspection does NOT imply insurability or warrant ability of the structure or its components. Although some safety issues may be addressed in this report, this inspection is NOT a safety/code inspection, and the inspector is NOT required to identify all potential hazards.

In this report, the inspector shall indicate, by checking the appropriate boxes on the form, whether each item was inspected, not inspected, not present or deficient and explain the findings in the corresponding section in the body of the report form. The inspector must check the Deficient (D) box if a condition exists that adversely and materially affects the performance of a system or component or constitutes a hazard to life, limb or property as specified by the TREC Standards of Practice. General deficiencies include inoperability, material distress, water penetration, damage, deterioration, missing components, and unsuitable installation. Comments may be provided by the inspector whether or not an item is deemed deficient. The inspector is not required to prioritize or emphasize the importance of one deficiency over another.

Some items reported may be considered life-safety upgrades to the property. For more information, refer to Texas Real Estate Consumer Notice Concerning Recognized Hazards or Deficiencies below.

THIS PROPERTY INSPECTION IS NOT A TECHNICALLY EXHAUSTIVE INSPECTION OF THE STRUCTURE, SYSTEMS OR COMPONENTS. The inspection may not reveal all deficiencies. A real estate inspection helps to reduce some of the risk involved in purchasing a home, but it cannot eliminate these risks, nor can the inspection anticipate future events or changes in performance due to changes in use or occupancy. It is recommended that you obtain as much information as is available about this property, including any seller's disclosures, previous inspection reports, engineering reports, building/remodeling permits, and reports performed for or by relocation companies, municipal inspection departments, lenders, insurers, and appraisers. You should also attempt to determine whether repairs, renovation, remodeling, additions, or other such activities have taken place at this property. It is not the inspector's responsibility to confirm that information obtained from these sources is complete or accurate or that this inspection is consistent with the opinions expressed in previous or future reports.

Report Identification: 10815 Lake Raven Ct. Cypress, TX. 77433

ITEMS IDENTIFIED IN THE REPORT DO NOT OBLIGATE ANY PARTY TO MAKE REPAIRS OR TAKE OTHER ACTIONS, NOR IS THE PURCHASER REQUIRED TO REQUEST THAT THE SELLER TAKE ANY ACTION. When a deficiency is reported, it is the client's responsibility to obtain further evaluations and/or cost estimates from qualified service professionals. Any such follow-up should take place prior to the expiration of any time limitations such as option periods.

Evaluations by qualified tradesmen may lead to the discovery of additional deficiencies which may involve additional repair costs. Failure to address deficiencies or comments noted in this report may lead to further damage of the structure or systems and add to the original repair costs. The inspector is not required to provide follow-up services to verify that proper repairs have been made.

Property conditions change with time and use. For example, mechanical devices can fail at any time, plumbing gaskets and seals may crack if the appliance or plumbing fixture is not used often, roof leaks can occur at any time regardless of the apparent condition of the roof, and the performance of the structure and the systems may change due to changes in use or occupancy, effects of weather, etc. These changes or repairs made to the structure after the inspection may render information contained herein obsolete or invalid. This report is provided for the specific benefit of the client named above and is based on observations at the time of the inspection. If you did not hire the inspector yourself, reliance on this report may provide incomplete or outdated information. Repairs, professional opinions or additional inspection reports may affect the meaning of the information in this report. It is recommended that you hire a licensed inspector to perform an inspection to meet your specific needs and to provide you with current information concerning this property.

TEXAS REAL ESTATE CONSUMER NOTICE CONCERNING HAZARDS OR DEFICIENCIES

Each year, Texans sustain property damage and are injured by accidents in the home. While some accidents may not be avoidable, many other accidents, injuries, and deaths may be avoided through the identification and repair of certain hazardous conditions. Examples of such hazards include:

- Malfunctioning, improperly installed, or missing ground fault circuit protection (GFCI) devices for electrical outlets in garages, bathrooms, kitchens, and exterior areas;
- Malfunctioning arc fault protection (AFCI) devices;
- Ordinary glass in locations where modern construction techniques call for safety glass;
- Malfunctioning or lack of fire safety features such as smoke alarms, fire-rated doors in certain locations, and functional emergency escape and rescue openings in bedrooms;
- Malfunctioning carbon monoxide alarms;
- Excessive spacing between balusters on stairways and porches;
- Improperly installed appliances;
- Improperly installed or defective safety devices; and
- Lack of electrical bonding and grounding; and
- Lack of bonding on gas piping, including corrugated stainless steel tubing (CSST).

To ensure that consumers are informed of hazards such as these, the Texas Real Estate Commission (TREC) has adopted Standards of Practice requiring licensed inspectors to report these conditions as "Deficient" when performing an inspection for a buyer or seller, if they can be reasonably determined.

These conditions may not have violated building codes or common practices at the time of the construction of the home, or they may have been "grandfathered" because they were present prior to the adoption of codes prohibiting such conditions. While the TREC Standards of Practice do not require inspectors to perform a code compliance inspection, TREC considers the potential for injury or property loss from the hazards addressed in the Standards of Practice to be significant enough to warrant this notice.

Contract forms developed by TREC for use by its real estate licensees also inform the buyer of the right to have the home inspected and can provide an option clause permitting the buyer to terminate the contract within a specified time. Neither the Standards of Practice nor the TREC contract forms require a seller to remedy conditions revealed by an inspection. The decision to correct a hazard or any deficiency identified in an inspection report is left to the parties to the contract for the sale or purchase of the home.

INFORMATION INCLUDED UNDER "ADDITIONAL INFORMATION PROVIDED BY INSPECTOR", OR PROVIDED AS AN ATTACHMENT WITH THE STANDARD FORM, IS NOT REQUIRED BY THE COMMISSION

Report Identification: 10815 Lake Raven Ct. Cypress, TX. 77433

AND MAY CONTAIN CONTRACTUAL TERMS BETWEEN THE INSPECTOR AND YOU, AS THE CLIENT. THE COMMISSION DOES NOT REGULATE CONTRACTUAL TERMS BETWEEN PARTIES. IF YOU DO NOT UNDERSTAND THE EFFECT OF ANY CONTRACTUAL TERM CONTAINED IN THIS SECTION OR ANY ATTACHMENTS, CONSULT AN ATTORNEY.

Additional Property Information Provided By HCAD/HAR/Inspector

Inspection Type: Single Family Home Year built: 2006 Stories: 2 Beds: 4 Full Baths: 3 Half Baths: 1

Approx. SF: 4017 Per HCAD & Per HAR Arrival Time: 7:50 Departure Time: 12:45

Home Status: Occupied Vacant New Construction Furnished Partially Furnished

Present at Inspection: Buyer Buyers Agent (at the end) Termite Inspector Seller Sellers Agent

Weather Conditions: Partly Cloudy Outside Temperature Range Between: 75-85 Degrees

Utilities On: Yes No Gas No Water No Power



For the purpose of this report and all references to direction within the report from the exterior (front, back, left & right sides) are based on observing the structure from the street & from within the interior (front, back, left & right sides) are based on entering the room.

The structure was occupied and furnished at the time of the inspection. Stored items and furnishings were located at various locations throughout the interior/exterior of the structure. This limited the accessibility of some of the items that are required to be inspected.



All opinions, observations or findings (whether listed as "I, NI, NP or D") in this report are based solely on the time and date of the actual inspection. This report has been paid for and prepared for by the client/clients named above and is not valid without a signed service agreement provided for review before, during or at the time of the inspection and is non transferable to any other person/persons except for the TREC Licensed Real Estate Professional representing the client/clients named above without the written consent of the inspector performing the inspection.

A real estate inspection is a limited visual inspection and basic operation of the systems and components of a structure using normal controls and does not require the use of specialized tools or procedures. The purpose of the inspection is to provide the client with information regarding the general condition of the structure at the time of inspection. The inspector may provide a higher level of inspection performance than required by the standards of practice and may inspect parts, components, and systems in addition to those described by the standards of practice. This inspection is not an engineering report, and should not be considered one. If any cause for concern is noted on the report, or if you would like further evaluation, you should consider an evaluation by a licensed engineer.

How to read and interpret this report: It is recommended that any deficiencies marked with a if any, are further evaluated, repaired, replaced or corrected by a qualified contractor/licensed professional in that field prior to closing. These items marked with a may be in need of repair, replacement or correction, may be a priority or safety item, may possibly indicate non-compliance with current building standards that may need to be monitored on a continual basis. It is the opinion of the inspector that all items marked with a should be addressed to client's satisfaction prior to closing. It is also recommended that any items of concern/general FYI information provided by the inspector marked with a  if any, should be corrected or monitored on a

continual basis. Pictures may be inserted below an item marked with a  or  to give a visual description of an item found as having a deficiency in need of repair, replacement or correction.

All recommendations/opinions, if any, given by the inspector are strictly the opinion of the inspector & should be further evaluated by a qualified contractor/licensed professional in that given field if the buyer has additional concerns/questions.

Some of the deficiencies/conditions that may be addressed marked with a  or items of concern/general FYI information provided by the inspector marked with a  in this report may not have violated building codes or common practices at the time of the construction of the home, or they may have been “grandfathered” because they were present prior to the adoption of codes prohibiting such conditions. An exhaustive list of these deficiencies/conditions may not be listed within the report. The buyer named above should consult with the inspector if any of these deficiencies/conditions are an item of concern.

Mold/Mildew & WDI inspections are not included in this report. It is beyond the scope of this inspection.

Comments underlined in bold lettering within the report are generally FYI (for your information) and may not require any action.

Inspector's Voluntary Notice

I hereby certify that I have no interest in this property or its improvements and that neither the retention of the Inspector to perform this inspection nor the compensation thereof is contingent on the cost or extent of any reported condition, association or relationship with any party. This inspection is limited and may not comply with future revisions of the Standards of Practice as so designated by the State. At each time of sale the property is recommended to be inspected as additional disclosures and repairs may become evident to any newer standards developed. It is recommended that all properties be re-inspected every two (2) years in order to keep up with any new standards developed or added and safety concerns.



Front of home

Additional pages may be attached to this report. Read them very carefully. This report may not be complete without the attachments. If an item is present in the property but is not inspected, the "NI" column will be checked and an explanation is necessary. Comments may be provided by the inspector whether or not an item is deemed in need of repair

I=Inspected NI =Not Inspected NP=Not Present D=Deficiency

I	N	N	D	Inspection Item
I	P			

I. STRUCTURAL SYSTEMS

A. Foundations

Type of Foundation(s): Post Tension Slab On Grade

Comments:

The performance of the foundation described within this report does not in anyway address future settlement or movement. Due to the expansive nature of the soil in the Houston area it is recommended that the foundation be monitored on a regular basis and the moisture content of the soil surrounding the foundation be kept at a consistant level.

The inspection of the foundation is limited to the visual observation of the accessible exterior and interior structural components at the time of the inspection. The inspector does not perform engineering studies or measurments. There are many factors which could limit the accuracy of the assessment of foundation performance. These include but may not be limited to: landscaping, patios, painting, repairs, areas behind walls, furnishing, decking, etc.

Foundation movement usually tends to produce a few large cracks, usually at least 1/16th inch wide, rather than a lot of small cracks. Cracks in brick veneer due to foundation movement will normally extend from the top of the wall to the bottom of the wall.

Cracking usually will be tapered if caused by foundation movement. By tapered I mean that the crack will be wider at the top or the bottom. If a crack is due to foundation movement, it will almost never be the same width at the top and bottom; such a crack is more likely to be due to thermal stresses than to foundation movement.

Considered as a whole, the pattern (meaning the location and taper) of the cracking should be consistent with a possible known mode of foundation distortion. For instance if a brick veneer wall shows cracks that were close to each other and one was wide at the top while the other was narrow at the top, it would usually be unreasonable to consider both cracks to be due to foundation movement since they are not both consistent with a known mode of foundation distortion.

Foundation movement usually results in cracks in drywall and brick veneer at weak points such as at the corners of windows and doors.

Cracks that show up after a long period of dry weather and tend to close when the weather turns wetter are usually due to foundation movement. Foundation movement can distort door openings causing doors and windows to stick and bind. Wallpaper may

Additional pages may be attached to this report. Read them very carefully. This report may not be complete without the attachments. If an item is present in the property but is not inspected, the "NI" column will be checked and an explanation is necessary. Comments may be provided by the inspector whether or not an item is deemed in need of repair

I=Inspected NI =Not Inspected NP=Not Present D=Deficiency

I	N	N	D	Inspection Item
I	P			

exhibit rucking at the inside corners of walls and at the intersection of walls and ceilings.

In some situations, finish floors can become perceptibly out-of-level. Unfortunately, floors are constructed out-of-level in some cases and foundations that undergo a normal range of movement can also become more or less out-of-level over time. Relating floor levelness to foundation movement is always based to a great degree on the judgment of the inspector, that judgment is always subjective and interpretative.

Brick courses, countertops and window stools can become noticeably out-of-level due to foundation distortion. These items are normally constructed to a tighter level tolerance than are floors

Foundation problems may result without proper maintenance on the homeowner's part. Maintenance may be accomplished by doing three things.

- 1. Provide good drainage away from the foundation.**
- 2. Water the soils surrounding the foundation on an as needed basis.**
- 3. Be aware of the potential for adverse affects caused by trees and shrubbery.**

Soil conditions in the area are known to be unstable. A program of conscientious watering of the soil in close proximity to the foundation to maintain consistent moisture content may help stabilize foundation movement caused by soil expansion and contraction. Should there be future issues concerning foundation condition, it is the opinion of the inspector that you consult with your builder or a licensed professional structural engineer.

Recommendations/opinions are based on observations made without the use of sophisticated testing procedures. Therefore, the recommendation/opinion expressed is one of an apparent condition and not based on absolute fact.

The inspector shall: Render a written opinion as to the performance of the foundation and Report: The type of foundations; The vantage point from which the crawl space was inspected (if present). Generally report present and visible indications used to render the opinion of adverse performance, such as: Binding, out-of-square, non-latching doors, framing or frieze board separations, sloping floors, window, wall, floor or ceiling cracks or separations, rotating, buckling, cracking, or deflecting masonry cladding. Report as Deficient: Deteriorated materials, deficiencies in foundation components such as; beams, joists, bridging, blocking, piers, posts, pilings, columns, sills or subfloor, Deficiencies in retaining walls related to foundation performance, exposed or damaged reinforcement, crawl space ventilation that is not performing and crawl space drainage that is not

Additional pages may be attached to this report. Read them very carefully. This report may not be complete without the attachments. If an item is present in the property but is not inspected, the "NI" column will be checked and an explanation is necessary. Comments may be provided by the inspector whether or not an item is deemed in need of repair

I=Inspected NI =Not Inspected NP=Not Present D=Deficiency

I	N	N	D	Inspection Item
	I	P		

performing.

It is recommended that any deficiencies/items of concern marked with a if any, are further evaluated/repaired/corrected by a qualified/licensed contractor prior to closing.

It is the opinion of the inspector that the foundation appears to be without the obvious need of immediate remedial leveling & is providing adequate support for the structure at the time of the inspection. The inspector did not observe any apparent evidence that would indicate the presence of significant deficiencies or adverse performance to the foundation however this was a limited visual inspection due to reasons as stated below & there were deficiencies as described below. This opinion is based solely on the areas of the foundation, attic, exterior and interior of the structure that were accessible at the time of the inspection. No warranty against future settlement can be made.

This was a limited visual foundation inspection due to a limited line of site to view the foundation wall in some areas due to improper grade clearances/vegetation in some areas around the perimeter of the structure.

A level was placed at various locations throughout the interior of the 1st floor of the structure and the amount of deflection was minimal.

Exposed rebar/tendon port was observed but may not be limited to the back side of the structure. Recommend sealing.



Additional pages may be attached to this report. Read them very carefully. This report may not be complete without the attachments. If an item is present in the property but is not inspected, the "NI" column will be checked and an explanation is necessary. Comments may be provided by the inspector whether or not an item is deemed in need of repair

I=Inspected NI =Not Inspected NP=Not Present D=Deficiency

I	N	N	D	Inspection Item
	I	P		

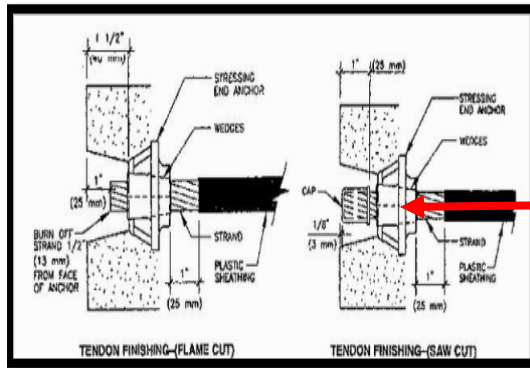

Ⓢ There were areas around the structure that were not accessible/visible due to the grade not having the minimum clearances of 4" for brick as required which limits the visibility of the foundation wall in these areas and the overall inspection of the foundation. Recommending pulling back/reworking the clearances in these areas to a minimum of 4" as required.

Ⓢ Stress cracks in the foundation wall were observed at one or more corners of the foundation. These cracks are not structurally significant however recommend sealing.

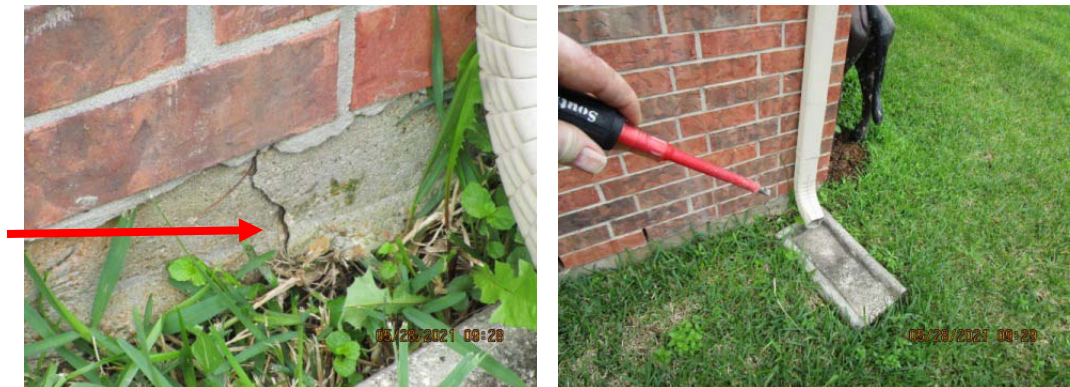

B. Grading and Drainage

Comments:

Proper grading and drainage is important to maintaining proper foundation performance, preventing water penetration, avoiding wood rot and preventing conditions which are conducive to wood destroying insects. It is recommended that grade be at a minimum of 4" from brick exteriors and 6" from wood/siding and grade sloped away from structure 6" in 10' to promote proper drainage.

Additional pages may be attached to this report. Read them very carefully. This report may not be complete without the attachments. If an item is present in the property but is not inspected, the “NI” column will be checked and an explanation is necessary. Comments may be provided by the inspector whether or not an item is deemed in need of repair

I=Inspected NI =Not Inspected NP=Not Present D=Deficiency

I	N	N	D	Inspection Item
	I	P		

Surface drainage shall be diverted to a storm sewer conveyance or other approved point of collection that does not create a hazard. Lots shall be graded to drain surface water away from foundation walls. The grade shall fall a minimum of 6 inches within the first 10'.

Exception: Where lot lines, walls, slopes or other physical barriers prohibit 6 inches of fall within 10 feet, drains or swales shall be constructed to ensure drainage away from the structure. Impervious surfaces within 10 feet of the building foundation shall be sloped a minimum of 2 percent away from the building.

All drainage and runoff shall be directed to the street. No ponding of surface water should be allowed near the structure during or after completion of rainfall/watering the yard.

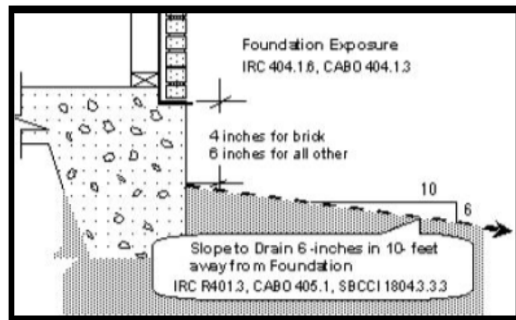

The inspection of the grading/drainage is done by visual observation of the site around the structure, including surface grade, retaining walls, rain gutters, etc. Visible conditions or symptoms that may indicate a situation which may adversely affect the foundation or indicate water penetration are reported. No soil, topographical or flood plain studies are performed.

Underground yard drainage systems are not checked/inspected. The inspector does not verify that yard drains operate properly and that there are no collapsed or clogged areas. The inspector (or anyone else) is unable to induce a sufficient quantity of water to determine if the system will operate properly when needed. Observe performance during heavy rains and ensure system is maintained/cleaned.

The inspector shall report as Deficient: Drainage around the foundation that is not performing, deficiencies in grade levels around the foundation and deficiencies in installed gutter and downspout systems.

It is recommended that any deficiencies/items of concern marked with a if any, are further evaluated/repaired/corrected by a contractor prior to closing.

Additional pages may be attached to this report. Read them very carefully. This report may not be complete without the attachments. If an item is present in the property but is not inspected, the "NI" column will be checked and an explanation is necessary. Comments may be provided by the inspector whether or not an item is deemed in need of repair

I=Inspected NI =Not Inspected NP=Not Present D=Deficiency

I	N	N	D	Inspection Item
	I	P		

Grading and drainage around the structure does not appear to be functioning as intended in all areas. Flat/improperly sloped areas were observed on the back & front sides of the structure. These conditions may be conducive to ponding which may have an adverse effect on the foundation/structure. It is recommended that the drainage improvements be made in these areas or that sub-surface drainage be installed to allow the water to flow freely away from the structure & to the street as required. After the drainage improvements have been made it is recommended that the drainage around the structure should be monitored during/after heavy rains & if ponding water is observed then additional drainage improvements should be performed.



There were areas on the front side of the structure where the grading does not having the minimum clearances of 4" for brick as required due to high mulch. Recommending pulling back/reworking the clearances in these areas to a minimum of 4" as required.

Some of the gutter down spouts do not divert water away from the foundation properly, down spouts should divert water away approximately 5' from foundation. Recommend adding splash blocks or diverters.



Additional pages may be attached to this report. Read them very carefully. This report may not be complete without the attachments. If an item is present in the property but is not inspected, the "NI" column will be checked and an explanation is necessary. Comments may be provided by the inspector whether or not an item is deemed in need of repair

I=Inspected NI =Not Inspected NP=Not Present D=Deficiency

I	N	N	D	Inspection Item
	I	P		

The gutter /down spout on the front side of the structure at the front porch area is not properly secured to the wall. Recommend securing.



The gutters are not properly installed behind the drip edge as recommended to prevent leaking between the gutter & fascia board.

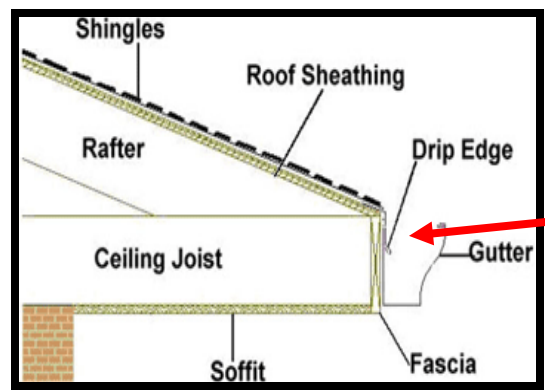

C. Roof Covering Materials

Type(s) of Roof Covering: Composition

Viewed From: Walked roof over the 1st floor & viewed the 2nd floor from the roofs edge & from the ground with binoculars from multiple points. The 2nd floor roof was not walked due to the access required the use of specialized equipment & due to the overall roof pitch. If the buyer has any concerns about the condition of the roof covering/materials it is recommended that a qualified roofer do an overall evaluation of the roof prior to closing.

Comments:

Additional pages may be attached to this report. Read them very carefully. This report may not be complete without the attachments. If an item is present in the property but is not inspected, the "NI" column will be checked and an explanation is necessary. Comments may be provided by the inspector whether or not an item is deemed in need of repair

I=Inspected NI =Not Inspected NP=Not Present D=Deficiency

I	N	N	D	Inspection Item
I	P			

Roof inspections are limited to the visual observation of accessible surfaces. The roof is only inspected from the roof level if it can be performed safely as determined by the inspector and without damaging the roof components. Certain types of damage/poor workmanship (improper fastening, manufacturer defects) may not be apparent at the time of the inspection therefore the inspector cannot guarantee that the roof will be free from leaks/defects, nor can the inspector determine the life expectancy of the roof.

If the roof was not walked due to the reason/reasons as stated above the inspector recommends that the roof be further evaluated/inspected by a qualified roofer prior to closing. The inspector cannot be liable for any damage/leaks or repairs to the roof after the original date of the inspection.

This report is based on the general condition of the roof at the time of the inspection. Keep in mind roof materials have a limited life and need regular maintenance/repairs. It is opinion of the inspector that the roof and rain gutters should be kept clear of all debris and monitored on a continual basis to prevent possible future water penetration.

The inspector shall: Inspect the roof covering materials from the surface of the roof; Report the type of roof coverings, vantage point from where the roof was inspected, evidence of water penetration, evidence of previous repairs to the roof covering material, flashing details, skylights and other roof penetrations and report as deficient deficiencies in: Fasteners, adhesion, roof covering materials, flashing details, skylights and other roof penetrations.

The inspector is not required to: Inspect the roof from the roof level if, in the inspector's reasonable judgment, the inspector: cannot safely reach or stay on the roof; or significant damage to the roof covering materials may result from walking on the roof.

It is recommended that any deficiencies/items of concern marked with a if any, are further evaluated/repaired/corrected by a qualified roofer prior to closing.

The homeowner and/or seller's disclosure should be consulted regarding the exact age of the roof covering. It is important to inspect the roof at least twice a year (spring & fall) and after heavy storms.

Roof covering/materials appeared to be functioning as intended however the roof showed normal signs of aging & there were deficiencies as described below. It is recommended that the budgeting for roof replacement in the future be considered & that the roof be monitored during times of rain to determine if any leaks are present.

Kick out flashing is not installed at the roof/wall line in the recommended areas. Due to the volume of water that can pour down a sloped roof one of the most critical flashing details

Additional pages may be attached to this report. Read them very carefully. This report may not be complete without the attachments. If an item is present in the property but is not inspected, the "NI" column will be checked and an explanation is necessary. Comments may be provided by the inspector whether or not an item is deemed in need of repair

I=Inspected NI =Not Inspected NP=Not Present D=Deficiency

I	N	N	D	Inspection Item
I	P			

occurs where a roof intersects a sidewall.

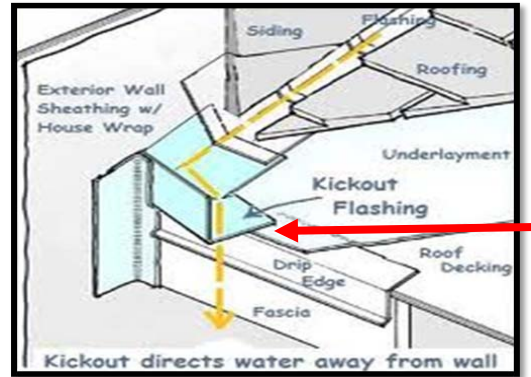

☒ Exposed nail heads were observed in some areas. Recommend sealing exposed nail heads.



☒ Shingle granule loss exposing asphalt was observed in some areas.

Additional pages may be attached to this report. Read them very carefully. This report may not be complete without the attachments. If an item is present in the property but is not inspected, the "NI" column will be checked and an explanation is necessary. Comments may be provided by the inspector whether or not an item is deemed in need of repair

I=Inspected NI =Not Inspected NP=Not Present D=Deficiency

I	N	N	D	Inspection Item
	I	P		



Roof shows evidence of sagging/deflection on the left side of roof by the water heater flue vent pipes. This may be due to improper structural support in the attic space.



D. Roof Structures and Attics

Attic viewed from: Entered attic space

Attic access location: Wet Bar Area

Attic structure consisted of: Rafters, Collar Ties, Joists, Bracing & Purlins

Rafter Size/Spacing: 2" x 6" & 2" x 8" w/varied spacing

Attic ventilation consisted of: Ridge Vents, Soffit Vents & Air Hawks

Insulation type: Blown & Blanket

Additional pages may be attached to this report. Read them very carefully. This report may not be complete without the attachments. If an item is present in the property but is not inspected, the "NI" column will be checked and an explanation is necessary. Comments may be provided by the inspector whether or not an item is deemed in need of repair

I=Inspected NI =Not Inspected NP=Not Present D=Deficiency

I	N	N	D	Inspection Item
I	P			

Approx. Average Thickness of Vertical Insulation: Approx. 6" where accessible.

Approx. Depth of Insulation: Approx. 12" where accessible.

Comments:

The inspection of the roof structure and attic is performed via visual observation of the areas and components which are safely accessible at the time of the inspection.

The inspector shall: Report the vantage point from which the attic space was inspected, approximate average depth of attic insulation, evidence of water penetration, report as Deficient: Attic space ventilation that is not performing, deflections or depressions in the roof surface as related to adverse performance of the framing and decking, missing insulation, deficiencies in installed framing members and decking, attic access ladders and access openings and attic ventilators.

It is recommended that any deficiencies/items of concern marked with a if any, are further evaluated/repared/corrected by a qualified tradesman/contractor prior to closing.

Roof structure/attic appeared to be stable and functioning as intended however this was a limited visual inspection & there were deficiencies observed as described below.

The roof decking is constructed from Tech Shield Radiant Barrier. This type of material limits the visual capability to detect possible moisture penetration/roof deck staining due to the aluminum type finish.

This was a limited attic inspection due to limited access & due to some areas were obstructed by duct work, equipment and insulation and were not accessible which limits the overall inspection of the roof and attic structure.

Missing insulation was observed in the attic space by the downstairs HVAC equipment. Recommend adding insulation to help reduce energy cost.

Additional pages may be attached to this report. Read them very carefully. This report may not be complete without the attachments. If an item is present in the property but is not inspected, the "NI" column will be checked and an explanation is necessary. Comments may be provided by the inspector whether or not an item is deemed in need of repair

I=Inspected NI =Not Inspected NP=Not Present D=Deficiency

I	N	N	D	Inspection Item
	I	P		



Existing moisture penetration staining was observed in the attic decking below the coil drain lines. A moisture reading was performed & moisture was detected at the time of the inspection. This is caused by condensation dripping from the primary drip pan drain lines.



Additional pages may be attached to this report. Read them very carefully. This report may not be complete without the attachments. If an item is present in the property but is not inspected, the "NI" column will be checked and an explanation is necessary. Comments may be provided by the inspector whether or not an item is deemed in need of repair

I=Inspected NI =Not Inspected NP=Not Present D=Deficiency

I	N	N	D	Inspection Item
	I	P		



 The attic access is missing insulation. Recommend sealing to help reduce energy cost.



 Evidence of rodent penetration was observed in the attic as noted by the bait trap.

E. Walls (Interior and Exterior)

Comments:

The condition of the framing or other components hidden behind the exterior/interior wall finishes are unknown to the inspector, therefore no opinion is given as to their current condition. The condition of the surface finishes are not noted, unless they may contribute to or be symptomatic of other issues. Home furnishing, landscaping and other personal items, ect. may limit the assessment of existing conditions.

Separation required. The garage shall be separated from the residence and its attic area by not less than 1/2-inch (12.7 mm) gypsum board applied to the garage side. Where the separation is a floor-ceiling assembly, the structure supporting the separation shall also

Additional pages may be attached to this report. Read them very carefully. This report may not be complete without the attachments. If an item is present in the property but is not inspected, the “NI” column will be checked and an explanation is necessary. Comments may be provided by the inspector whether or not an item is deemed in need of repair

I=Inspected NI =Not Inspected NP=Not Present D=Deficiency

I	N	N	D	Inspection Item
	I	P		

be protected by not less than 1/2-inch (12.7 mm) gypsum board or equivalent.

The inspector is not qualified to inspect for wood destroying insects. Evidence of damage to wood material, if any, may not be determined without the removal of the wall coverings. Client should obtain additional information regarding the extent and location of previous infestation, if any & the chemical & company used and any warranty if applicable, etc..

The inspector shall report evidence of water penetration. Report as Deficient the absence of performing emergency escape and rescue openings in all sleeping rooms, deficiencies related to structural performance or water penetration, claddings, water resistant materials and coatings and flashing details and terminations.

It is recommended that any deficiencies/items of concern marked with a if any, are further evaluated/repaired/corrected by a qualified tradesman/contractor prior to closing.

Exterior Walls:

Type: Brick Facade with Cement Board Siding & Cement Board/Wood Trim

Exterior walls are functioning as intended however this was a limited visual, non-destructive exterior wall inspection. There were deficiencies observed as described below.

The garage interior walls could not be fully inspected due to heavily stored items in the garage.



A damaged/loose brick with cracking in the brick/mortar façade & a hole in the brick was observed between the garage doors on the front side of the structure. The damage/cracking

Additional pages may be attached to this report. Read them very carefully. This report may not be complete without the attachments. If an item is present in the property but is not inspected, the "NI" column will be checked and an explanation is necessary. Comments may be provided by the inspector whether or not an item is deemed in need of repair

I=Inspected NI =Not Inspected NP=Not Present D=Deficiency

I	N	N	D	Inspection Item
	I	P		

appeared to be due to exposed lintel that has rusted causing damage. Recommend further evaluation/repair.

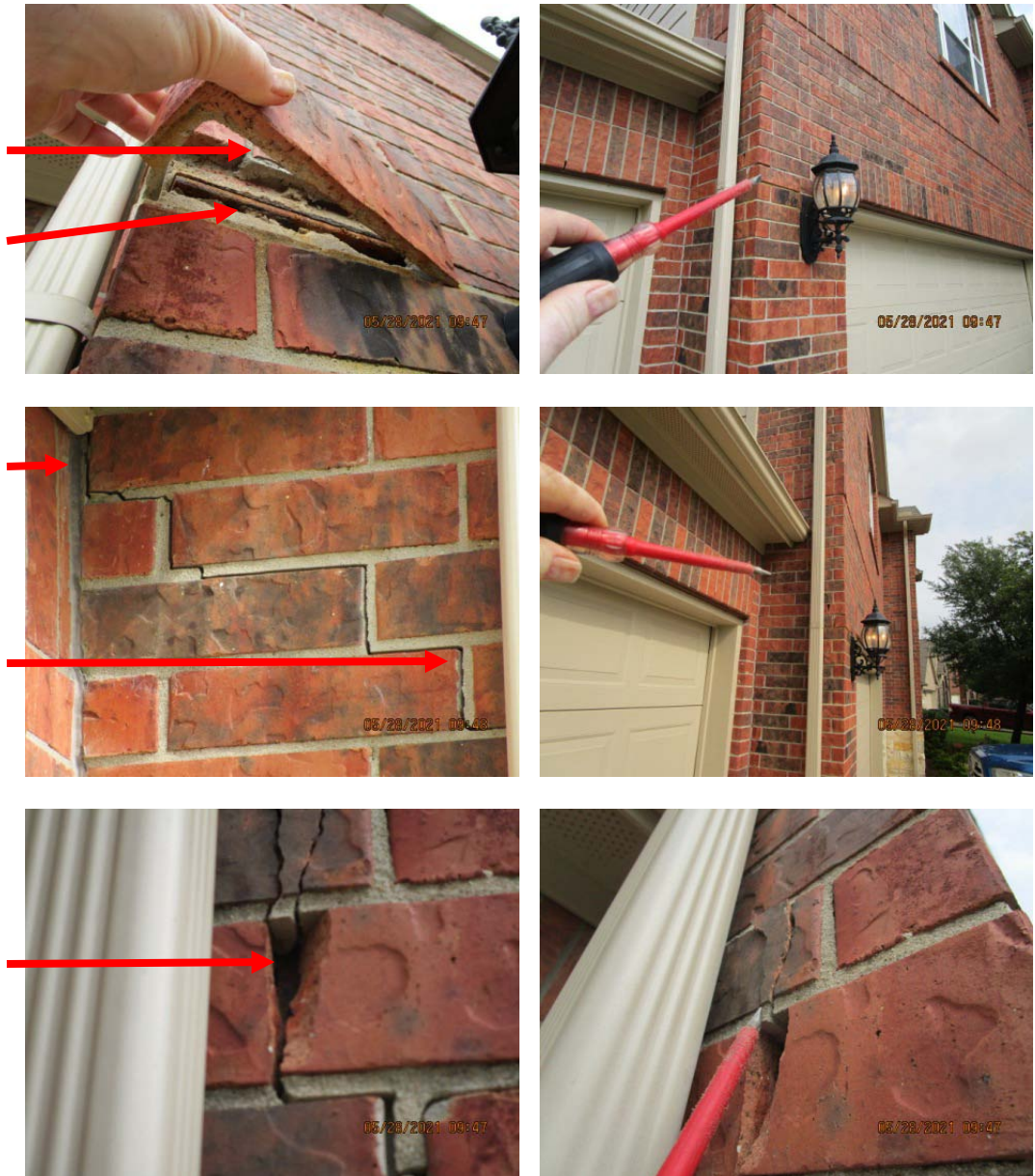

Additional pages may be attached to this report. Read them very carefully. This report may not be complete without the attachments. If an item is present in the property but is not inspected, the "NI" column will be checked and an explanation is necessary. Comments may be provided by the inspector whether or not an item is deemed in need of repair

I=Inspected NI =Not Inspected NP=Not Present D=Deficiency

I	N	N	D	Inspection Item
	I	P		

☒ Rust was observed on some of the exposed lintels at the openings above doors/windows etc. in multiple areas on both the front, back & right sides of the structure. Recommend removing rust & priming/painting the exposed lintels.

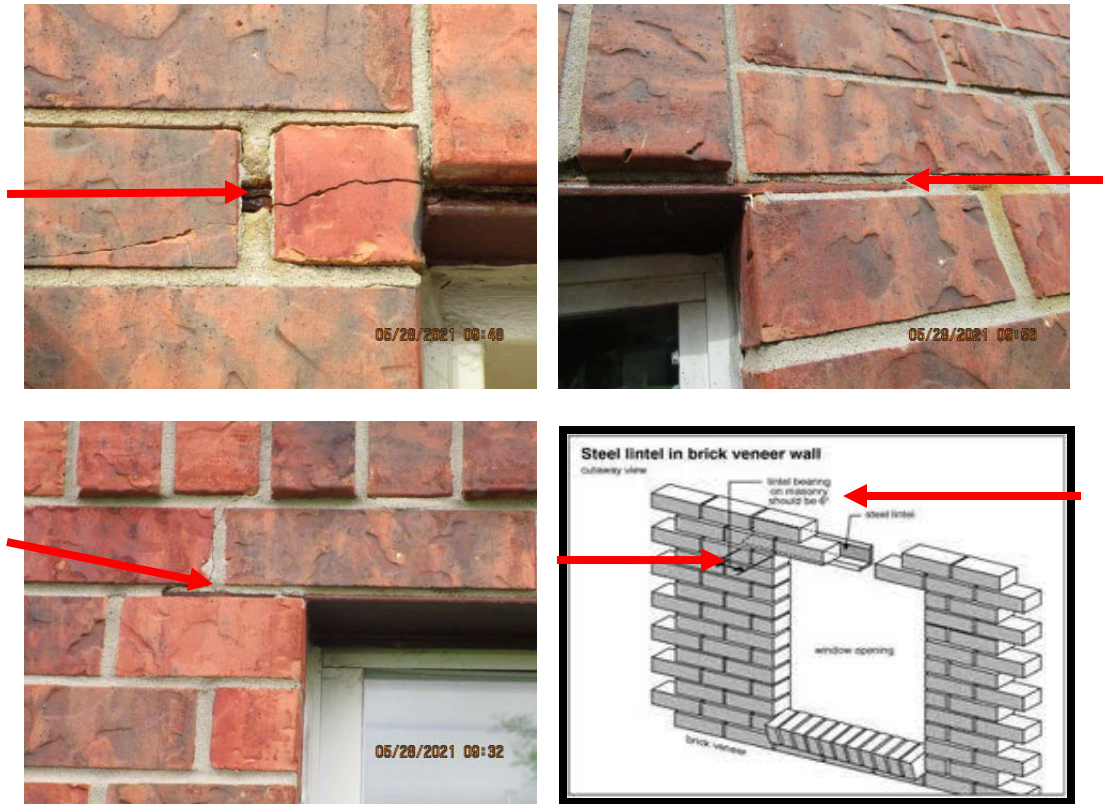

☒ Missing/loose brick mortar was observed above the front porch area possible resulting in loose bricks/brick. Recommend repair.

Additional pages may be attached to this report. Read them very carefully. This report may not be complete without the attachments. If an item is present in the property but is not inspected, the "NI" column will be checked and an explanation is necessary. Comments may be provided by the inspector whether or not an item is deemed in need of repair

I=Inspected NI =Not Inspected NP=Not Present D=Deficiency

I	N	N	D	Inspection Item
	I	P		



Flashing is not installed above the horizontal trim boards. Flashing is required above all continuously projected trim.

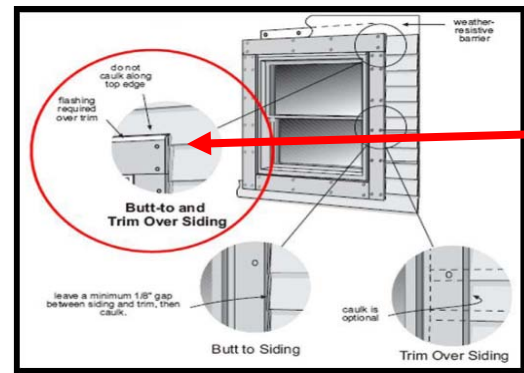

Missing/loose mortar was observed on the front side of the structure. Recommend replacing.

Report Identification: 10815 Lake Raven Ct. Cypress, TX. 77433

Additional pages may be attached to this report. Read them very carefully. This report may not be complete without the attachments. If an item is present in the property but is not inspected, the "NI" column will be checked and an explanation is necessary. Comments may be provided by the inspector whether or not an item is deemed in need of repair

I=Inspected NI =Not Inspected NP=Not Present D=Deficiency

I	N	N	D	Inspection Item
	I	P		

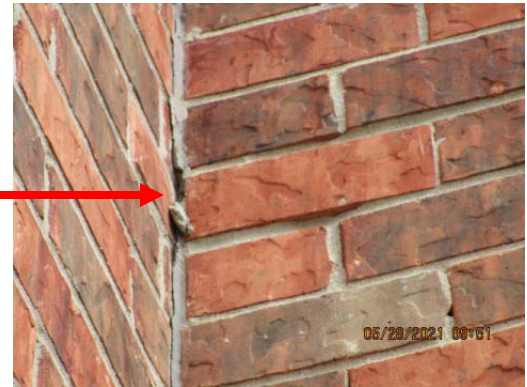

 Weep holes are not installed over some of the windows & at the back porch columns.



Additional pages may be attached to this report. Read them very carefully. This report may not be complete without the attachments. If an item is present in the property but is not inspected, the "NI" column will be checked and an explanation is necessary. Comments may be provided by the inspector whether or not an item is deemed in need of repair

I=Inspected NI =Not Inspected NP=Not Present D=Deficiency

I	N	N	D	Inspection Item
	I	P		

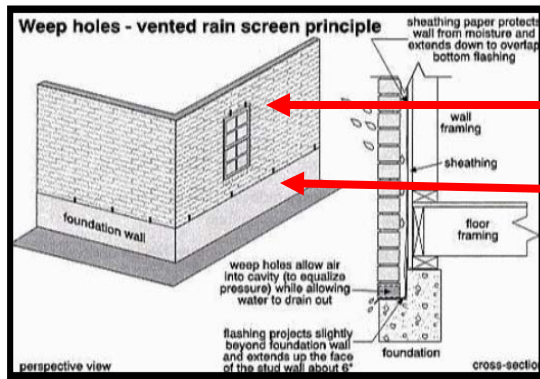

 Recommend sealing all exterior penetrations to prevent possible moisture penetration including but may not be limited to: Electrical penetration, exhaust vents, door bell, electrical panel/disconnect/conduit penetrations.



 Hairline cracking in the brick/mortar facade was observed on the back & front side of the structure. Recommend monitoring.

Additional pages may be attached to this report. Read them very carefully. This report may not be complete without the attachments. If an item is present in the property but is not inspected, the "NI" column will be checked and an explanation is necessary. Comments may be provided by the inspector whether or not an item is deemed in need of repair

I=Inspected NI =Not Inspected NP=Not Present D=Deficiency

I	N	N	D	Inspection Item
	I	P		



Interior Walls:

The inspector shall report evidence of water penetration. Report as Deficient deficiencies related to structural performance or water penetration and the absence of or deficiencies in fire separation between the garage and the living space and between the garage and its attic.

The home was occupied and furnished at the time of the inspection. Stored items and furnishings were located at various locations throughout the interior of the structure. This limited the accessibility of some of the interior walls that are required to be inspected.

Interior walls are functioning as intended however this was a limited visual, non-destructive interior wall inspection & there were deficiencies observed as described below. A moisture reading was performed at various locations & the levels were within the acceptable range except for as noted below.

A thermal imaging camera was used at the exterior walls from within the interior of the structure & no anomalies were observed at the time of the inspection.

Additional pages may be attached to this report. Read them very carefully. This report may not be complete without the attachments. If an item is present in the property but is not inspected, the "NI" column will be checked and an explanation is necessary. Comments may be provided by the inspector whether or not an item is deemed in need of repair

I=Inspected NI =Not Inspected NP=Not Present D=Deficiency

I	N	N	D	Inspection Item
	I	P		

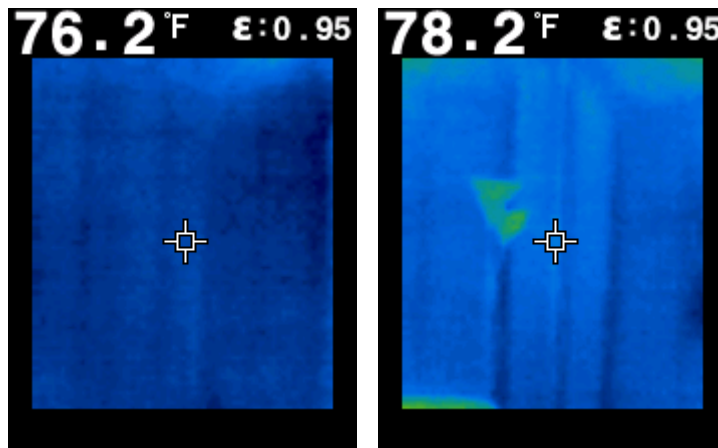

Existing/previous moisture penetration was observed but may not be limited to the base of the wall at the double doors in the game room on the interior of the structure. A moisture reading was performed & moisture was detected at the time of the inspection. Recommend to determine if any hidden structure damage has occurred.



Additional pages may be attached to this report. Read them very carefully. This report may not be complete without the attachments. If an item is present in the property but is not inspected, the "NI" column will be checked and an explanation is necessary. Comments may be provided by the inspector whether or not an item is deemed in need of repair

I=Inspected NI =Not Inspected NP=Not Present D=Deficiency

I	N	N	D	Inspection Item
	I	P		



 Minor cosmetic cracks were observed in some areas. This is normal wear & tear that is caused by movement that occurs in any structure of its life. These are considered normal wear & tear items & are not considered to be excessive or unreasonable structural deficiencies. This condition can be easily repaired with the applications of sheetrock mud or caulking.

F. Ceilings and Floors

Comments:

The condition of the framing or other components hidden behind the interior ceiling/floor finishes are unknown to the inspector, therefore no opinion is given as to their current condition. The condition of the surface finishes are not noted unless they may contribute to or be symptomatic of other issues. Home furnishing and other personal items, etc. may limit the assessment of existing conditions.

The inspector shall report evidence of water penetration. Report as Deficient deficiencies related to structural performance or water penetration and the absence of or deficiencies in fire separation between the garage and the living space and between the garage and its attic.

It is recommended that any deficiencies/items of concern marked with a if any, are further evaluated/repaired/corrected by a qualified tradesman/contractor prior to closing.

Ceilings are functioning as intended however this was a limited visual, non-destructive inspection.

A thermal imaging camera was used at various areas of the ceiling on the interior of the structure & no anomalies were observed at the time of the inspection.

Additional pages may be attached to this report. Read them very carefully. This report may not be complete without the attachments. If an item is present in the property but is not inspected, the "NI" column will be checked and an explanation is necessary. Comments may be provided by the inspector whether or not an item is deemed in need of repair

I=Inspected NI =Not Inspected NP=Not Present D=Deficiency

I	N	N	D	Inspection Item
	I	P		

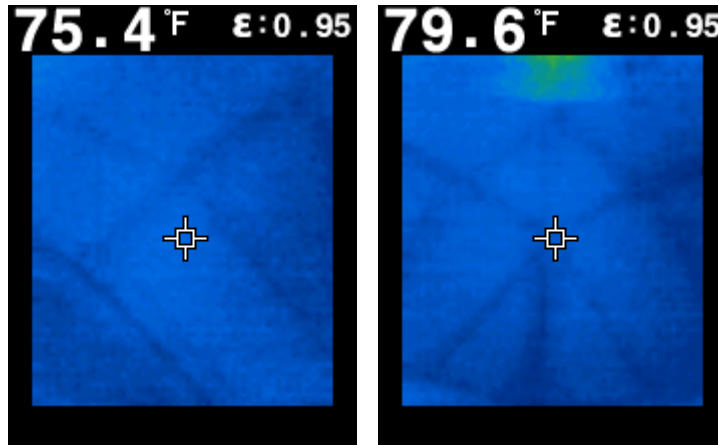

Minor cosmetic cracks were observed in some areas. This is normal wear & tear that is caused by movement that occurs in any structure of its life. These are considered normal wear & tear items & are not considered to be excessive or unreasonable structural deficiencies. This condition can be easily repaired with the applications of sheetrock mud or caulking.

Floors are functioning as intended however there were deficiencies as described below.

The home was occupied and furnished at the time of the inspection. Stored items and furnishings were located at various locations throughout the interior of the structure. This limited the accessibility of some of the interior flooring that is required to be inspected.

A significant drop in the flooring in the upstairs jack & jill bathroom was observed. The flooring is not level & drops approx. 1 1/2" in a 3'-4' span. Recommend further evaluation to determine the source of the drop & to determine what/if any corrective measures may be required.



Additional pages may be attached to this report. Read them very carefully. This report may not be complete without the attachments. If an item is present in the property but is not inspected, the "NI" column will be checked and an explanation is necessary. Comments may be provided by the inspector whether or not an item is deemed in need of repair

I=Inspected NI =Not Inspected NP=Not Present D=Deficiency

I	N	N	D	Inspection Item
	I	P		

Floor grout is missing from the flooring in the wet bar area. Recommend repairing.



G. Doors (Interior and Exterior)

Comments:

All accessible interior/exterior doors are inspected to determine if they are functioning properly, including locking hardware and latches.

Exterior Doors:

Exit door required: Not less than one exit door shall be provided from each dwelling unit. The required exit door shall provide for direct access from the habitable portions of the dwelling to the exterior without requiring travel through a garage.

Type of lock or latch: All egress doors shall be readily operable from the side from which egress is to be made without the use of a key or special knowledge or effort.

The inspector shall: Report evidence of water penetration, report as Deficient a solid wood door less than 1-3/8 inches in thickness, a solid or honeycomb core steel door less than 1-3/8 inches thick, or a 20-minute fire-rated door between the residence and an attached garage, deficiencies related to structural performance or water penetration, deficiencies in weather stripping, gaskets or other air barrier materials, claddings, water resistant materials and coatings, flashing details and terminations, the condition and performance of exterior doors, garage doors and hardware.

It is recommended that any deficiencies/items of concern marked with a if any, are further evaluated/repaired/corrected by a qualified tradesman/contractor prior to closing.

Additional pages may be attached to this report. Read them very carefully. This report may not be complete without the attachments. If an item is present in the property but is not inspected, the "NI" column will be checked and an explanation is necessary. Comments may be provided by the inspector whether or not an item is deemed in need of repair

I=Inspected NI =Not Inspected NP=Not Present D=Deficiency

I	N	N	D	Inspection Item
	I	P		

Exterior doors are functioning as intended however there were deficiencies as described below.

A thermal imaging camera was used at the exterior doors from within the interior of the structure & no anomalies were observed at the time of the inspection.

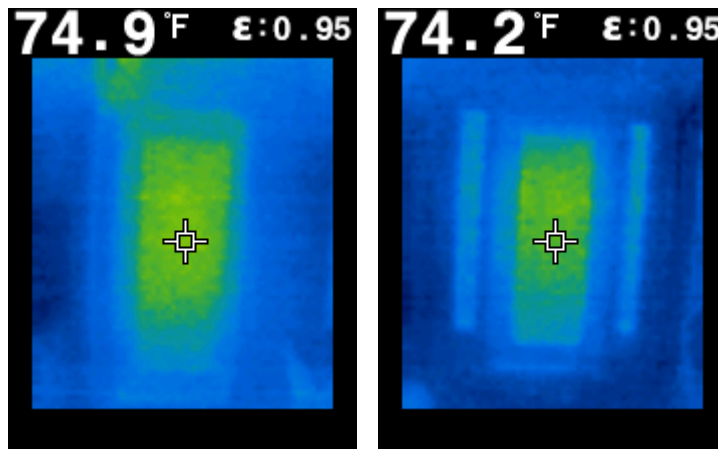

The door leading from the interior to the garage does not have self closing hinges installed to close the door when the door is released. Although not required in some areas it is recommended that self closing hinges be installed to help prevent unwanted fumes from entering the structure.

The floor sweep at the back door is damaged.



The bottom mortised bolt at the double door in the game room could not be disengaged under normal conditions & the door could not be opened. Recommend repair.

Additional pages may be attached to this report. Read them very carefully. This report may not be complete without the attachments. If an item is present in the property but is not inspected, the "NI" column will be checked and an explanation is necessary. Comments may be provided by the inspector whether or not an item is deemed in need of repair

I=Inspected NI =Not Inspected NP=Not Present D=Deficiency

				Inspection Item
I	N	N	D	
	I	P		



 The double door leading from the game room to the balcony is missing the top mortised bolt strike.



 The back door off the breakfast area does not stay in the open position, the door swings back to the closed position when released. Recommend adjusting.

Interior Doors:

Interior doors are functioning as intended however there were deficiencies as described below.

The door leading into the jack & jill bath would not latch when closed. Recommend adjusting.

The door leading into the utility room hits the frame & is difficult to close. Recommend adjusting.

Additional pages may be attached to this report. Read them very carefully. This report may not be complete without the attachments. If an item is present in the property but is not inspected, the "NI" column will be checked and an explanation is necessary. Comments may be provided by the inspector whether or not an item is deemed in need of repair

I=Inspected NI =Not Inspected NP=Not Present D=Deficiency

I	N	N	D	Inspection Item
	I	P		

The doors leading into the media room & the master bathroom are extremely difficult to close under normal condition due to the top spring latches. Recommend adjusting/replacing.



The doors leading into the cannot be latched due to the top spring latch is missing. Recommend replacing.



H. Windows

Comments:

Only the accessible windows will be checked for operation during the inspection if the structure is occupied at the time of the inspection. Failed thermal paned seals in insulated glass windows are not always detectable. In some conditions the inspector may not be able to detect this condition, particularly if the windows are dirty or if it's raining during the inspection. The visible moisture between panes in a failed seal situation may be apparent or not, due to variations in atmospheric conditions. Windows are reported as they are observed at the time of the inspection only.

Additional pages may be attached to this report. Read them very carefully. This report may not be complete without the attachments. If an item is present in the property but is not inspected, the "NI" column will be checked and an explanation is necessary. Comments may be provided by the inspector whether or not an item is deemed in need of repair

I=Inspected NI =Not Inspected NP=Not Present D=Deficiency

I	N	N	D	Inspection Item
I	P			

The inspector shall report evidence of water penetration. Report as Deficient the absence of performing emergency escape and rescue openings in all sleeping rooms, missing or damaged screens, deficiencies related to structural performance or water penetration, deficiencies in weather stripping, gaskets or other air barrier materials, claddings, water resistant materials and coatings, flashing details and terminations and the condition and performance of windows and components. The inspector shall report as Deficient insulated windows that are obviously fogged or display other evidence of broken seals, deficiencies in glazing, weather stripping and glazing compound in windows and doors and the absence of safety glass in hazardous locations.

It is recommended that any deficiencies/items of concern marked with a if any, are further evaluated/repaired/corrected by a qualified tradesman/contractor prior to closing.

Type: Double Pane Aluminum

Windows are functioning as intended however there were deficiencies as described below.

Some of the windows are dirty which may limits the visual inspection of the window.

A thermal imaging camera was used at the windows from within the interior of the structure & no anomalies were observed at the time of the inspection.

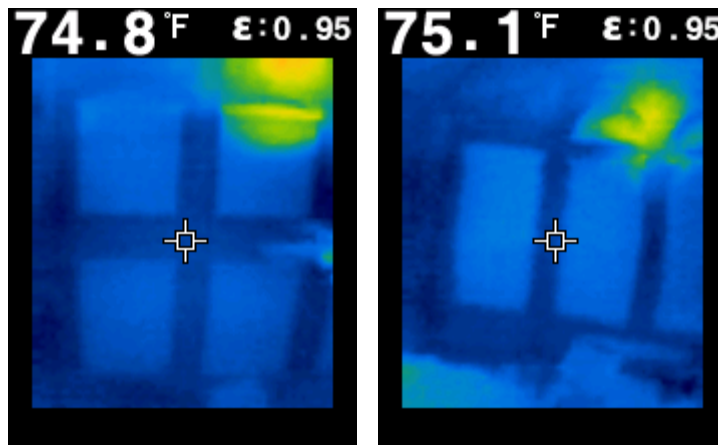

Unable to determine the presence of safety/tempered glass at the window to the right of the front door due to not being able to located the tempered/safety glass etching. Safety/tempered glass is required by today's standards.

Additional pages may be attached to this report. Read them very carefully. This report may not be complete without the attachments. If an item is present in the property but is not inspected, the "NI" column will be checked and an explanation is necessary. Comments may be provided by the inspector whether or not an item is deemed in need of repair

I=Inspected NI =Not Inspected NP=Not Present D=Deficiency

I	N	N	D	Inspection Item
	I	P		



Missing & damaged screen was observed on the back side of the structure. Recommend repairing/replacing.

Holes were drilled & alarm sensors have been installed into some of the window frame sills. Buyer should ensure that all holes remain properly sealed to prevent possible moisture penetration into the wall cavity.



I. Stairways (Interior and Exterior)

Comments:

It is recommended that any deficiencies/items of concern marked with a if any, are further evaluated/repared/corrected by a qualified tradesman/contractor prior to closing.

The inspector shall report as Deficient spacing between intermediate balusters, spindles, or rails for steps, stairways, guards, and railings that permit passage of an object greater than 4 inches in diameter, except that on the open side of the staircase treads, spheres

Additional pages may be attached to this report. Read them very carefully. This report may not be complete without the attachments. If an item is present in the property but is not inspected, the "NI" column will be checked and an explanation is necessary. Comments may be provided by the inspector whether or not an item is deemed in need of repair

I=Inspected NI =Not Inspected NP=Not Present D=Deficiency

I	N	N	D	Inspection Item
	I	P		

less than 4-3/8 inches in diameter may pass through the guard rail balusters or spindles; and deficiencies in steps, stairways, landings, guardrails, and handrails.

Stairway is functioning as intended however there were deficiencies as described below.

The stair riser heights shall not be more than 7 3/4". The greatest riser height within any flight of stairs shall not exceed the smallest by more than 3/8". The riser heights varied from approx. 7" - 8".



J. Fireplaces & Chimneys

Comments:

The inspection of the fireplace and chimney is a visual inspection of the accessible components of the firebox, hearth, damper, doors, attic penetration, chimney crown and cricket. Dirty chimneys are a fire hazzard due to the accumulation of combustible creosote. Consult a certified chimney sweep annually for cleaning and inspection.

The inspector shall report as Deficient built-up creosote in accessible areas of the firebox and flue, the presence of combustible materials in near proximity to the firebox opening, the absence of fire blocking at the attic penetration of the chimney flue, where accessible and deficiencies in the damper, lintel, hearth, hearth extension, and firebox, gas valve and location, circulating fan, combustion air vents and chimney structure, termination, coping, crown, caps, and spark arrestor.

It is recommended that any deficiencies/items of concern marked with a if any, are further evaluated/repared/corrected by a qualified tradesman/contractor prior to closing.

Type Of Fireplace: Prefab Gas Log/Wood Burning

Additional pages may be attached to this report. Read them very carefully. This report may not be complete without the attachments. If an item is present in the property but is not inspected, the "NI" column will be checked and an explanation is necessary. Comments may be provided by the inspector whether or not an item is deemed in need of repair

I=Inspected NI =Not Inspected NP=Not Present D=Deficiency

I	N	N	D	Inspection Item
	I	P		

Fireplace/chimney are functioning as intended.



 Damper does not have a damper block/stop installed. In the event that gas logs are installed in the fireplace at a future date the damper should have a damper block installed to prevent the damper from being closed.

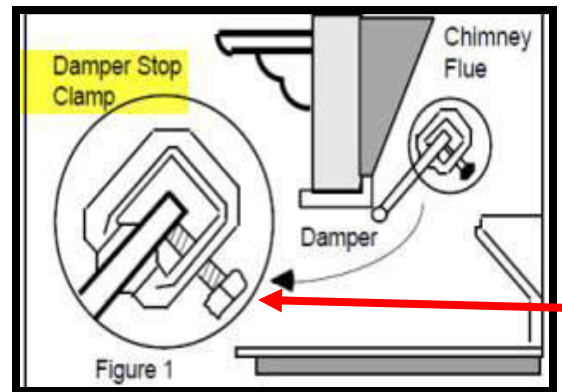

K. Porches, Balconies, Decks and Carports

Comments:

It is recommended that any deficiencies/items of concern marked with a if any, are further evaluated/repared/corrected by a qualified tradesman/contractor prior to closing.

The inspector shall inspect attached balconies, carports, and porches, abutting porches, decks, and balconies that are used for ingress and egress and report as Deficient on decks 30 inches or higher above the adjacent grade, spacings between intermediate balusters, spindles, or rails that permit passage of an object greater than four inches in

Additional pages may be attached to this report. Read them very carefully. This report may not be complete without the attachments. If an item is present in the property but is not inspected, the "NI" column will be checked and an explanation is necessary. Comments may be provided by the inspector whether or not an item is deemed in need of repair

I=Inspected NI =Not Inspected NP=Not Present D=Deficiency

I	N	N	D	Inspection Item
	I	P		

diameter and deficiencies in accessible components.

Are functioning as intended.

L. Other

Comments:

It is recommended that any deficiencies/items of concern marked with a if any, are further evaluated/repared/corrected by a qualified tradesman/contractor prior to closing.

Driveway/Garage Slab: Driveway/Garage Slab are functioning as intended.

The garage slab could not be fully inspected due to heavily stored items in the garage.

 Hairline cracking was observed in the garage slab & driveway.

Walk Way: Walkway is functioning as intended.

Fencing/Gate: Appeared to be functioning as intended.

Cabinets: Appeared to be functioning as intended however there were deficiencies as described below.

 Signs of moisture penetration was observed under the jack & jill bathroom sinks. A moisture reading was performed & moisture was detected at the time of the inspection. The moisture appears to be the result of the p-traps condensating from the cold condensation from the AC coils in the attic.



Additional pages may be attached to this report. Read them very carefully. This report may not be complete without the attachments. If an item is present in the property but is not inspected, the "NI" column will be checked and an explanation is necessary. Comments may be provided by the inspector whether or not an item is deemed in need of repair

I=Inspected NI =Not Inspected NP=Not Present D=Deficiency

I	N	N	D	Inspection Item
	I	P		



II. ELECTRICAL SYSTEMS

A. Service Entrance and Panels

Comments:

The inspection of the electrical system is limited to the visible and accessible components at the time of the inspection. A major portion of the electrical system is hidden behind walls and ceiling finishes and are not accessible at the time of the inspection, therefore, no evaluation of performance of these items are given.

When it can be performed safely, as determined by the inspector, the dead front (a panel designed and located in the electrical panel to prevent exposure to the live wires within the electrical panel) will be removed to inspect the existing condition of the breakers and conductors as in relation to proper sizing and to determine if there are any signs of overheating/double tapped conductors.

A typical electrical system consists of two distinct components: (1) the electric service entrance, and (2) the branch circuits. The service entrance determines the capacity of the electric power available to the home. The electric circuits distribute the power throughout the home. Electrical devices in a home typically use either 120 or 240 voltage electricity. The major appliances such as clothes dryers, kitchen ranges, water heaters, air conditioners, and electric heating units require 240 volts. General-purpose circuits (lighting, outlets, etc.) require 120 volts.

The inspector shall report as Deficient a drop, weatherhead or mast that is not securely fastened to the building. The absence of or deficiencies in the grounding electrode system, missing or damaged dead fronts or covers plates, conductors not protected from the edges of electrical cabinets, gutters, or cutout boxes. Electrical cabinets and panel boards not appropriate for their location; such as a clothes closet, bathrooms or where they are exposed to physical damage. Electrical cabinets and panel boards that are not

Additional pages may be attached to this report. Read them very carefully. This report may not be complete without the attachments. If an item is present in the property but is not inspected, the "NI" column will be checked and an explanation is necessary. Comments may be provided by the inspector whether or not an item is deemed in need of repair

I=Inspected NI =Not Inspected NP=Not Present D=Deficiency

I	N	N	D	Inspection Item
I	P			

accessible or do not have a minimum of 36-inches of clearance in front of them. Deficiencies in electrical cabinets, gutters, cutout boxes, and panel boards, the insulation of the service entrance conductors, drip loop, separation of conductors at weather heads and clearances. The compatibility of over current devices and conductors, the over current device and circuit for labeled and listed 240 volt appliances, bonding and grounding, conductors, the operation of installed ground-fault or arc-fault circuit interrupter devices and the absence of trip ties on 240 volt over current devices or multi-wire branch circuit, appropriate connections, anti-oxidants on aluminum conductor terminations and a main disconnecting means.

It is recommended that any deficiencies/items of concern marked with a if any, are further evaluated/repaired/corrected by a licensed electrician prior to closing.

Service entrance & panel appeared to be functioning as intended however there were deficiencies as described below.

Service Entrance: Service provided from underground.

Main Panel:

Brand: Square D

Amps: 200

Type of feeder wire: 4/0 Aluminum 3 wire 120/240 service

Panel Location: Garage interior

The dead front was removed and the interior of the panel was inspected.

No anti-oxidizing compound was observed on aluminum feeder wires. Recommend installing anti- oxidizing compound.

Additional pages may be attached to this report. Read them very carefully. This report may not be complete without the attachments. If an item is present in the property but is not inspected, the "NI" column will be checked and an explanation is necessary. Comments may be provided by the inspector whether or not an item is deemed in need of repair

I=Inspected NI =Not Inspected NP=Not Present D=Deficiency

I	N	N	D	Inspection Item
	I	P		

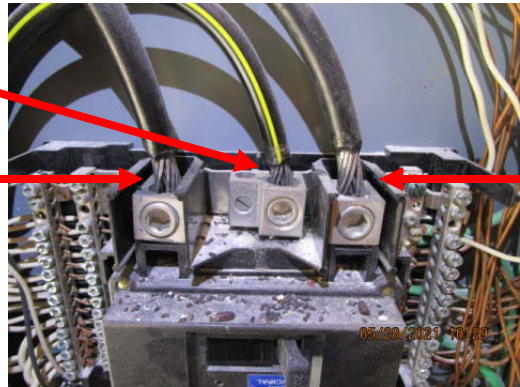

 Grounding electrode was buried, not able to determine if the grounding conductor/clamp is present/properly connected.



B. Branch Circuits, Connected Devices and Fixtures

Type of Wiring: Copper

Comments:

The inspection of the branch circuits, connected devices & fixtures is limited to the visible and accessible components at the time of the inspection. A major portion of the electrical system is hidden behind walls and ceiling finishes and are not accessible at the time of the inspection, therefore, no evaluation of performance of these items are given.

The inspector shall manually test the installed and accessible smoke and carbon monoxide alarms, report the type of branch circuit conductors. Report as Deficient the absence of ground-fault circuit interrupter protection in all bathroom receptacles, garage receptacles, outdoor receptacles, crawl space receptacles, unfinished basement

Additional pages may be attached to this report. Read them very carefully. This report may not be complete without the attachments. If an item is present in the property but is not inspected, the "NI" column will be checked and an explanation is necessary. Comments may be provided by the inspector whether or not an item is deemed in need of repair

I=Inspected NI =Not Inspected NP=Not Present D=Deficiency

I	N	N	D	Inspection Item
I	P			

receptacles, kitchen countertop receptacles and receptacles that are located within six feet of the outside edge of a sink.

The failure of operation of ground-fault circuit interrupter protection devices, missing or damaged receptacle, switch or junction box covers. The absence of equipment disconnects, appropriate connections, such as copper/aluminum approved devices, if branch circuit aluminum conductors are discovered in the main or sub-panel based on a random sampling of accessible receptacles and switches. Deficiencies in receptacles, switches, bonding or grounding, wiring, wiring terminations, junction boxes, devices, and fixtures, including improper location, doorbell and chime components, smoke and carbon monoxide alarms, improper use of extension cords, deficiencies in or absences of conduit, where applicable and the absence of smoke alarms in each sleeping room, outside each separate sleeping area in the immediate vicinity of the sleeping rooms and in the living space of each story of the dwelling.

It is recommended that any deficiencies/items of concern marked with a if any, are further evaluated/repared/corrected by a licensed electrician prior to closing.

Electrical Fixtures:

Electrical fixtures appeared to be functioning as intended however there were deficiencies as described below.

The home was occupied and furnished at the time of the inspection. Stored items and furnishings were located at various locations throughout the interior/exterior of the structure. This limited the accessibility of some of the electrical fixtures that are required to be inspected.

(Ground Fault Circuit Interrupter, a safety device that senses any shock hazard and interrupts the flow of electricity in the circuit)

GFCI Protection: (Safety Protection)

Kitchen: Yes (GFCI reset located in the kitchen)

Breakfast Area: Yes (GFCI reset located in the breakfast area)

Wet Bar: Yes (GFCI reset located at the wet bar)

Bathrooms: Yes (GFCI reset located in the master & jack & jill bathrooms)

Jetted Bathtub (if/when installed): Yes (GFCI reset located in the master water closet)

Additional pages may be attached to this report. Read them very carefully. This report may not be complete without the attachments. If an item is present in the property but is not inspected, the "NI" column will be checked and an explanation is necessary. Comments may be provided by the inspector whether or not an item is deemed in need of repair

I=Inspected NI =Not Inspected NP=Not Present D=Deficiency

I	N	N	D	Inspection Item
	I	P		

Exterior: Yes (GFCI reset located in the garage)

Garage: Yes/No (GFCI reset located in the garage)

GFCI protection is not available for all the outlets in the garage as required by today's standards.

AFCI (Arc Fault Circuit Interrupt) device protection, as required by current building standards, for all: family rooms, dining rooms, living rooms, parlors, libraries, dens, bedrooms, sunrooms, recreations rooms, closets, hallways, or similar rooms or areas. AFCI devices are intended to protect against fires caused by electrical arcing faults in the home's wiring. Arc faults are a common cause of residential electrical fires. Arc faults can be created by damaged, deteriorated, or worn electrical plugs, cords, and/or branch circuit conductors.

As of September 1, 2008, the State of Texas has adopted the 2005 NEC, which includes this requirement, as the "minimum standard" for all non-exempt electrical work. Homes built prior to 2002, generally were not required to have arc fault protection.

Present in bedrooms only. Arc-fault protection (arc-fault breakers) is not present for electrical outlets as required by today's standards in the family rooms, dining rooms, living rooms, parlors, libraries, dens, sunrooms, recreation rooms, closets, hallways, or similar rooms or areas. The breakers were not tripped due to the structure being occupied.

Not all of the light fixtures functioned as intended in the attic area.

Equipment switch cover plate in the attic is damaged. Recommend the replacing of cover plate.

Some of the light fixtures did not function possibly due to burnt/missing bulbs. It is recommended that all burnt bulbs be replaced & the light fixtures are turned on to determine if the fixtures function as intended.

One of the light sockets at the jack & jill bath sink is damaged. Recommend replacing.

Additional pages may be attached to this report. Read them very carefully. This report may not be complete without the attachments. If an item is present in the property but is not inspected, the "NI" column will be checked and an explanation is necessary. Comments may be provided by the inspector whether or not an item is deemed in need of repair

I=Inspected NI =Not Inspected NP=Not Present D=Deficiency

I	N	N	D	Inspection Item
	I	P		



Insufficient number of outlets installed to the right of the cook top in the kitchen by today's standards. Outlets should be provided every 4' of counter space, 2' max. distance between outlets. Counters with a minimum of 2' should have at least one outlet. No point along a kitchen countertop greater that 2' from an outlet.





The conduit supporting the condensing unit is not properly secured/sealed. Recommend securing/sealing to prevent moisture penetration.

Additional pages may be attached to this report. Read them very carefully. This report may not be complete without the attachments. If an item is present in the property but is not inspected, the "NI" column will be checked and an explanation is necessary. Comments may be provided by the inspector whether or not an item is deemed in need of repair

I=Inspected NI =Not Inspected NP=Not Present D=Deficiency

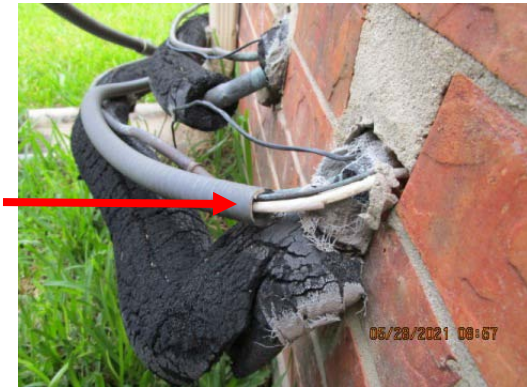
I	N	N	D	Inspection Item
	I	P		



 No spark arrestors were observed at the kitchen & breakfast area outlets.



 All exterior light fixtures exposed to weather conditions should be properly sealed.



Additional pages may be attached to this report. Read them very carefully. This report may not be complete without the attachments. If an item is present in the property but is not inspected, the "NI" column will be checked and an explanation is necessary. Comments may be provided by the inspector whether or not an item is deemed in need of repair

I=Inspected NI =Not Inspected NP=Not Present D=Deficiency

I	N	N	D	Inspection Item
	I	P		

 CSST Gas piping was observed at the water heater & heating equipment. There have been reported issues that the CSST metal piping may not be properly bonded & no bonding jumper was observed at the CSST line. Recommend further evaluation/repair by a licensed electrician to determine that the CCST is properly bonded as required & if not properly bonded then it is recommended that a bonding jumper be added.

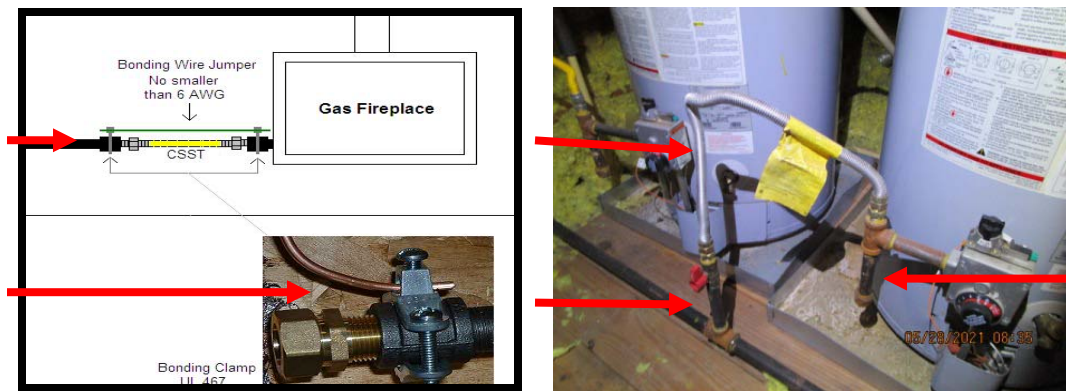

Door Bell and Chimes:

Door bell is functioning as intended.

Carbon Monoxide Detectors:

Carbon Monoxide Detectors are not required due to being an all electric structure.

Note: Carbon monoxide detectors are tested using the manufacturer supplied test button only. This inspection does not include testing units with actual CO.

The installation of carbon monoxide detector(s) is required outside of all bedrooms and in immediate vicinity of the bedrooms. Detectors should be tested on a regular basis or per manufacture instructions.

Smoke Alarms:

Smoke alarms appeared to be functioning as intended.

Additional pages may be attached to this report. Read them very carefully. This report may not be complete without the attachments. If an item is present in the property but is not inspected, the "NI" column will be checked and an explanation is necessary. Comments may be provided by the inspector whether or not an item is deemed in need of repair

I=Inspected NI =Not Inspected NP=Not Present D=Deficiency

I	N	N	D	Inspection Item
	I	P		



Note: Smoke detectors are tested using the manufacturer supplied test button only. This inspection does not include testing units with actual smoke.

The installation of smoke alarm(s) is required inside of all bedrooms and in any rooms designated for the purpose of sleeping, and outside within the proximity of the doors to those rooms & a minimum of 1 detector is required on each level.

Test all alarms and detectors weekly or monthly per manufacture instructions. The installation of carbon monoxide (CO) detector(s) is required in homes with fuel-fired appliances at every floor elevation and any areas where fuel-fired equipment is located. The installation of Type ABC fire extinguisher(s) at the kitchen, laundry, and garage, if applicable, is also advised. Test all of these devices monthly. Install new batteries semi-annually. Initiate and practice plans of escape and protection for all occupants in case any emergencies arise. Failure to repair defective or install absent alarms, detectors, and other safety equipment immediately can result in serious injury or death.

III. HEATING, VENTILATION AND AIR CONDITIONING SYSTEMS

-
-
-
-

A. Heating Equipment

Type of Systems: Central/Forced Air

Number of Systems: 2

Additional pages may be attached to this report. Read them very carefully. This report may not be complete without the attachments. If an item is present in the property but is not inspected, the "NI" column will be checked and an explanation is necessary. Comments may be provided by the inspector whether or not an item is deemed in need of repair

I=Inspected NI =Not Inspected NP=Not Present D=Deficiency

I	N	N	D	Inspection Item
I	P			

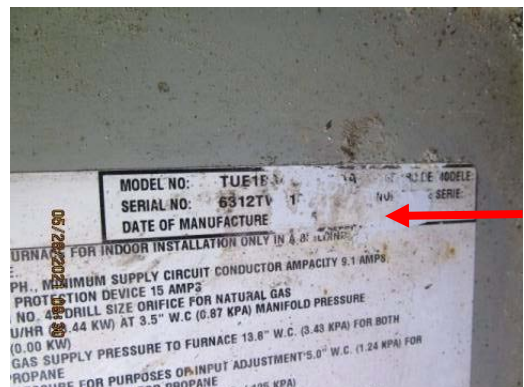
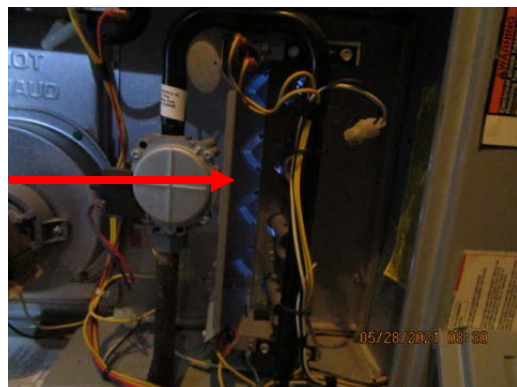
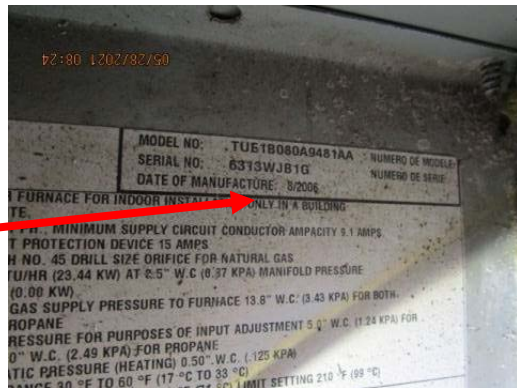
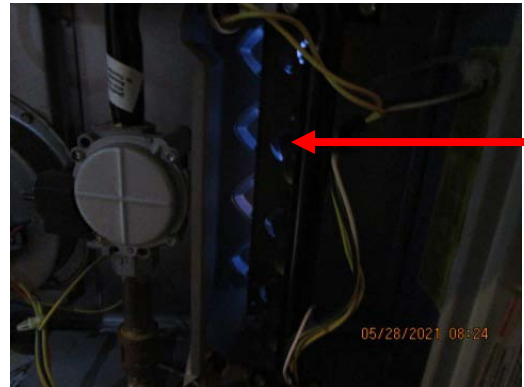
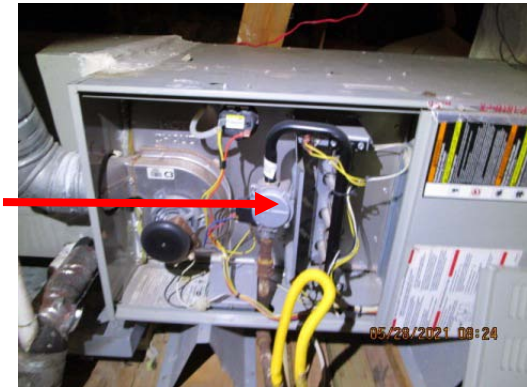

Energy Sources: Gas

Brands: Trane

Additional pages may be attached to this report. Read them very carefully. This report may not be complete without the attachments. If an item is present in the property but is not inspected, the "NI" column will be checked and an explanation is necessary. Comments may be provided by the inspector whether or not an item is deemed in need of repair

I=Inspected NI =Not Inspected NP=Not Present D=Deficiency

I	N	N	D	Inspection Item
I	P			

Mfg. Date/Dates: 2006 (both heaters) (According to the Manufacturer Label/Labels on the equipment at the time of the inspection)

Comments:

The visual inspection of the heating, ventilation and ducting equipment does not include internal parts that require disassembling of the unit to visually inspect. The condition of the HVAC equipment is based on the performance of the system when tested under normal conditions and those components that are visually accessible at the time of inspection. Full evaluation of the integrity of such components as a heat exchanger, require dismantling of the systems and is beyond the scope of a visual inspection.

The inspector shall report the type of heating systems and the energy sources. Report as Deficient inoperative units, deficiencies in the thermostats, inappropriate location, the lack of protection from physical damage, burners, burner ignition devices or heating elements, switches, and thermostats that are not a minimum of 18 inches above the lowest garage floor elevation, unless the unit is listed for garage floor installation. The absence of an opening that would allow access to equipment for inspection, service, repair or replacement without removing permanent construction or building finish. When applicable a floored passageway and service platform that would allow access for equipment inspection, service, repair or replacement and deficiencies in mounting and performance of window and wall units.

Requirements for electric units. The inspector shall report deficiencies in performance of heat pumps, performance of heating elements and condition of conductors.

Requirements for gas units. The inspector shall report as Deficient gas leaks, flame impingement, uplifting flame, improper flame color, or excessive scale buildup. The absence of a gas shut-off valve within six feet of the appliance, the absence of a gas appliance connector or one that exceeds six feet in length, gas appliance connectors that are concealed within or extended through walls, floors, partitions, ceilings or appliance housings and deficiencies in combustion, and dilution air, gas shut-off valves, access to a gas shutoff valves that prohibits full operation, gas appliance connector materials and the vent pipe, draft hood, draft, proximity to combustibles, and vent termination point and clearances.

It is recommended that the heating system/air handler be professionally inspected/cleaned prior to closing & on an annual basis by a licensed HVAC technician & it is recommended that any deficiencies/items of concern marked with a if any, are further evaluated/repaired/corrected by a licensed HVAC technician prior to closing.

The below referenced temperature reading/readings were performed using a Fieldpiece SPK2 Folding Pocket In-Duct Thermometer with MAX/MIN Hold and Stainless Steel

Additional pages may be attached to this report. Read them very carefully. This report may not be complete without the attachments. If an item is present in the property but is not inspected, the "NI" column will be checked and an explanation is necessary. Comments may be provided by the inspector whether or not an item is deemed in need of repair

I=Inspected NI =Not Inspected NP=Not Present D=Deficiency

I	N	N	D	Inspection Item
	I	P		

Probe.

The heating equipment was operated and is functioning as intended.

Supply air temp: 117.3 Degrees (as measured at the downstairs heat exchanger in the attic) & 127.6 degrees (as measured at the upstairs heat exchanger in the attic)



B. Cooling Equipment

Type of Systems: Central/Split System

Number of Systems: 2

Sizes: 4 tons (downstairs condenser) & 3.5 tons (upstairs condenser)

Brands: Trane

Condensing Unit Manufacturer Date/Dates: 2007 (downstairs) & 2006 (upstairs)
(According to the Manufacturer Label/Labels on the equipment at the time of the inspection)

Additional pages may be attached to this report. Read them very carefully. This report may not be complete without the attachments. If an item is present in the property but is not inspected, the “NI” column will be checked and an explanation is necessary. Comments may be provided by the inspector whether or not an item is deemed in need of repair

I=Inspected NI =Not Inspected NP=Not Present D=Deficiency

I	N	N	D	Inspection Item
I	P			

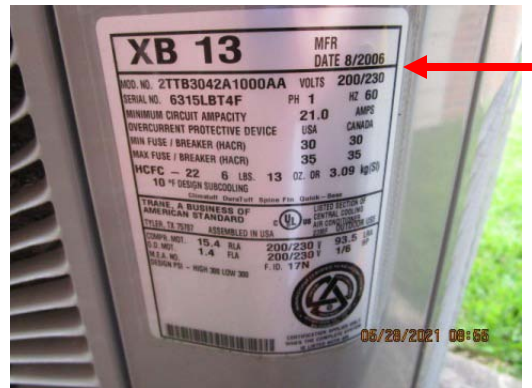

Evaporator Coil Manufacturer Date/Dates: 2017 (downstairs) & 2018 (upstairs)
 (According to the Manufacturer Label/Labels on the equipment at the time of the inspection)

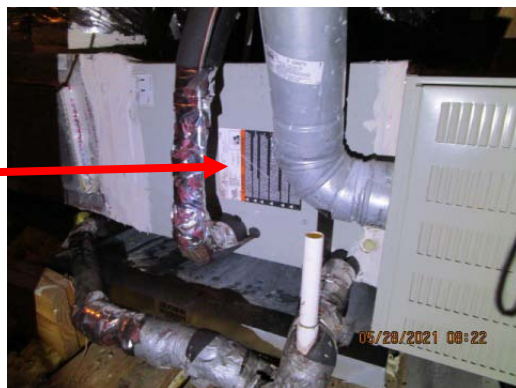

Report Identification: 10815 Lake Raven Ct. Cypress, TX. 77433

Additional pages may be attached to this report. Read them very carefully. This report may not be complete without the attachments. If an item is present in the property but is not inspected, the “NI” column will be checked and an explanation is necessary. Comments may be provided by the inspector whether or not an item is deemed in need of repair

I=Inspected NI =Not Inspected NP=Not Present D=Deficiency

I	N	N	D	Inspection Item
	I	P		

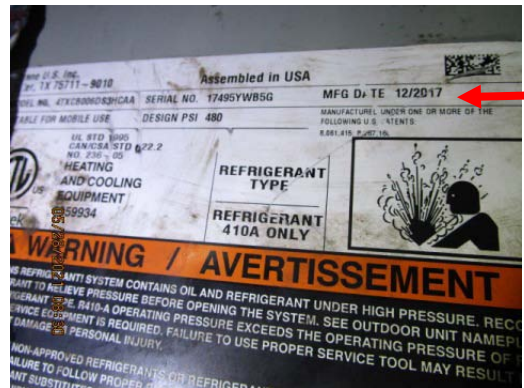
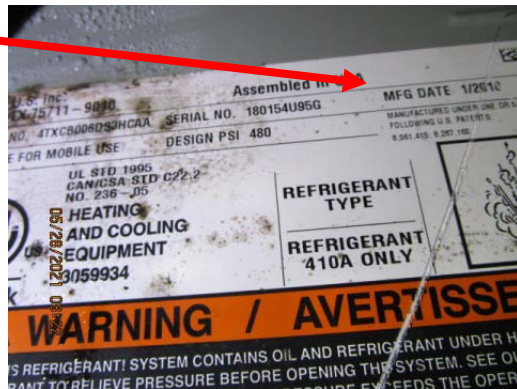

Comments:

The visual inspection of the cooling, ventilation and ducting equipment does not include internal parts that require disassembling of the unit to visually inspect. The condition of the HVAC equipment is based on the performance of the system when tested under normal conditions and those components that are visually accessible at the time of inspection. Full evaluation of the integrity of such components condensing unit/evaporator coil, require dismantling of the systems and is beyond the scope of a visual inspection.

Requirements for cooling units other than evaporative coolers. The inspector shall report the type of systems. The inspector shall report as Deficient, inoperative units, inadequate cooling as demonstrated by its performance, the absence of an opening that would allow access to equipment for inspection, service, repair or replacement without removing permanent construction or building finish, when applicable, a floored passageway and service platform that would allow access for equipment inspection, service, repair or replacement, noticeable vibration of blowers or fans, water in the auxiliary/secondary drain pan, a primary drain pipe that discharges in a sewer vent,

Additional pages may be attached to this report. Read them very carefully. This report may not be complete without the attachments. If an item is present in the property but is not inspected, the "NI" column will be checked and an explanation is necessary. Comments may be provided by the inspector whether or not an item is deemed in need of repair

I=Inspected NI =Not Inspected NP=Not Present D=Deficiency

I	N	N	D	Inspection Item
	I	P		

missing or deficient refrigerant pipe insulation, dirty coils where accessible, condensing units lacking adequate clearances or air circulation or that has deficiencies in the fins, location, levelness, or elevation above grade surfaces. Deficiencies in the condensate drain and auxiliary/secondary pan and drain system, mounting and performance of window or wall units and thermostats.

It is recommended that the cooling system/air handler be professionally inspected/cleaned prior to closing & on an annual basis by a licensed HVAC technician & it is recommended that any deficiencies/items of concern marked with a ☒ if any, are further evaluated/repaired/corrected by a licensed HVAC technician prior to closing.

The below referenced temperature reading/readings were performed using a Fieldpiece SPK2 Folding Pocket In-Duct Thermometer with MAX/MIN Hold and Stainless Steel Probe.

Downstairs supply air temp: 53.1 Degrees (as measured at the discharge side of the coil in the attic) Return air temp: 71.6 degrees (as measured at the return side in the attic)



Upstairs supply air temp: 50.7 Degrees (as measured at the discharge side of the coil in the attic) Return air temp: 71.1 degrees (as measured at the return side in the attic)

Additional pages may be attached to this report. Read them very carefully. This report may not be complete without the attachments. If an item is present in the property but is not inspected, the "NI" column will be checked and an explanation is necessary. Comments may be provided by the inspector whether or not an item is deemed in need of repair

I=Inspected NI =Not Inspected NP=Not Present D=Deficiency

I	N	N	D	Inspection Item
	I	P		



A variance of 15 - 21 degree between the supply and return air is considered to be functioning as intended.

The cooling equipment was operated and is functioning as intended however there were deficiencies as described below.

An access panel has been installed on the supply side of the coils to inspect the evaporator coils in the attic. Dust/debris was observed on the coils which may be restricting the airflow through the coils inhibiting the heat transfer across the coils which may be reducing the cooling efficiency & increasing operating cost. Due to the extent of the dirty coils it is recommended that the evaporator coil be further evaluated by a licensed HVAC Technician prior to closing.



The condensing units did not have the required 3" clearance from grade.

The condensing unit coils are dirty. This reduces the air flow, recommend cleaning.

Additional pages may be attached to this report. Read them very carefully. This report may not be complete without the attachments. If an item is present in the property but is not inspected, the "NI" column will be checked and an explanation is necessary. Comments may be provided by the inspector whether or not an item is deemed in need of repair

I=Inspected NI =Not Inspected NP=Not Present D=Deficiency

I	N	N	D	Inspection Item
	I	P		

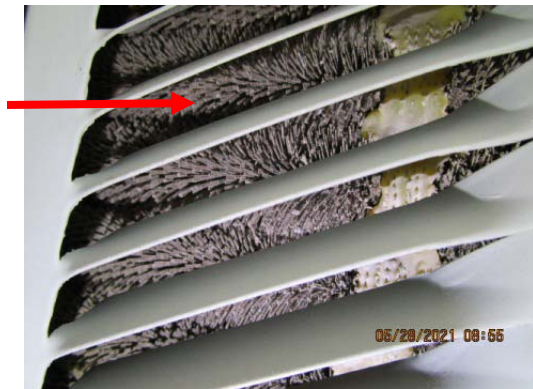

Missing/aging insulation on the refrigeration line was observed at the condensing units. Recommend replacing.

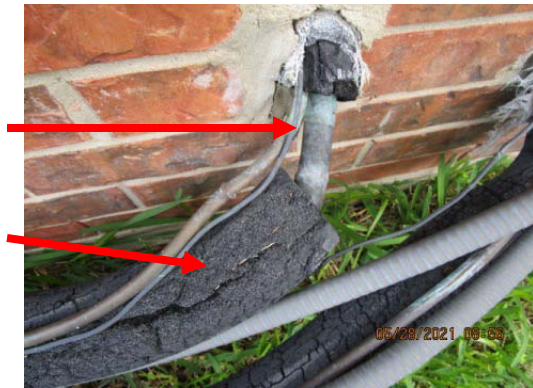

Rust and condensation were observed in the secondary drip pans in the attic. Recommend repairing and monitored on a continual basis.

Additional pages may be attached to this report. Read them very carefully. This report may not be complete without the attachments. If an item is present in the property but is not inspected, the "NI" column will be checked and an explanation is necessary. Comments may be provided by the inspector whether or not an item is deemed in need of repair

I=Inspected NI =Not Inspected NP=Not Present D=Deficiency

I	N	N	D	Inspection Item
	I	P		

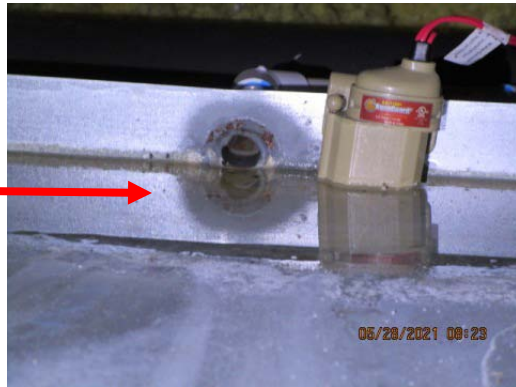

The refrigerant used for the condensing units is the older R-22 which is being phased out, recharging of a R22 system may not be possible in the future which may required that the system be replaced.

The condensing units showed signs of aging & are potentially nearing the end of their life cycle. Recommend budgeting for replacement in the future.

C. Ducts System, Chases and Vents:

Comments:

It is recommended that any deficiencies/items of concern marked with a if any, are further evaluated/repared/corrected by a licensed HVAC Technician prior to closing.

The inspector shall report as Deficient damaged duct systems or improper material, damaged or missing duct insulation, the absence of air flow at accessible supply registers, the presence of gas piping and sewer vents concealed in ducts, plenums and chases, ducts or plenums in contact with earth and the inspector shall report as Deficient deficiencies in filters, grills or registers and the location of return air openings.

Duct Type: Flex

Duct System appeared to be functioning as intended however this was a limited duct system inspection due to limited access in some areas of the attic & between the walls/floors.

Condensation & rust was observed on the supply air plenums & coils in the attic. Recommend further evalaution/repair.

Additional pages may be attached to this report. Read them very carefully. This report may not be complete without the attachments. If an item is present in the property but is not inspected, the "NI" column will be checked and an explanation is necessary. Comments may be provided by the inspector whether or not an item is deemed in need of repair

I=Inspected NI =Not Inspected NP=Not Present D=Deficiency

I	N	N	D	Inspection Item
	I	P		



The flex duct was observed to be in direct contact with other pieces of duct in some areas of the attic. Recommend adding insulation between the ducts or rerouting ducts should be considered to prevent condensation between the ducts.



The duct board/transition for the downstairs evaporator coil in the attic is not properly sealed at the top side of the coil & is blowing conditioned air into the attic space. Recommend repair.

Additional pages may be attached to this report. Read them very carefully. This report may not be complete without the attachments. If an item is present in the property but is not inspected, the "NI" column will be checked and an explanation is necessary. Comments may be provided by the inspector whether or not an item is deemed in need of repair

I=Inspected NI =Not Inspected NP=Not Present D=Deficiency

I	N	N	D	Inspection Item
	I	P		



Chases & Vents appeared to be functioning as intended however this was a limited inspection due to limited access in some areas.

Estimated Return Air Filter Sizes: 20" x 25" x 1", 20" x 30" x 1" & 12" x 12" x 1" (3 filters located at the returns in the ceiling)

Return air filter is dirty, recommend replacing.



IV. PLUMBING SYSTEM

A. Plumbing System, Distribution System & Fixtures

Location of Water Meter: Front yard

Location of Main Water Supply/Shut Off Valve: Right side exterior

Static Water Pressure Reading: 56 PSI (A reading between 40 - 80 PSI is considered acceptable.)

Additional pages may be attached to this report. Read them very carefully. This report may not be complete without the attachments. If an item is present in the property but is not inspected, the “NI” column will be checked and an explanation is necessary. Comments may be provided by the inspector whether or not an item is deemed in need of repair

I=Inspected NI =Not Inspected NP=Not Present D=Deficiency

I	N	N	D	Inspection Item
	I	P		



Type Of Supply Piping: CPVC (where accessible)

Comments:

A plumbing system consists of three major components, the supply piping, the waste and vent piping, and the fixtures. The supply piping brings the water to the fixture from a private well or public water main. The supply piping is smaller diameter piping that operates under pressure. These pipes must be watertight. The waste piping carries the water from the fixture to a private septic system or to a public sewer line. The drain or waste piping does not operate under pressure, instead typically uses gravity to drain the water from the fixture to the septic tank or sewer. Thus, these pipes must slope in order function properly.

The inspector shall report the location of water meter, location of homeowners main water supply shutoff valve and static water pressure. Report as Deficient the presence of active leaks, the lack of a pressure reducing valve when the water pressure exceeds 80 PSI, the lack of an expansion tank at the water heater(s) when a pressure reducing valve is in place at the water supply line/system, the absence of fixture shut-off valves, dielectric unions, when applicable, back-flow devices, anti-siphon devices, or air gaps at the flow end of fixtures and deficiencies in water supply pipes and waste pipes. The installation and termination of the vent system, the performance of fixtures and faucets not connected to an appliance. Water supply, as determined by viewing functional flow in two fixtures operated simultaneously, fixture drain performance, orientation of hot and cold faucets, installed mechanical drain stops , commodes, fixtures, showers, tubs, and enclosures and the condition of the gas distribution system.

It is recommended that any deficiencies/items of concern marked with a ☒ if any, are further evaluated/repaired/corrected by a licensed plumber prior to closing.

Personal items stored in the cabinets under sinks may limit the assessment of existing

Additional pages may be attached to this report. Read them very carefully. This report may not be complete without the attachments. If an item is present in the property but is not inspected, the "NI" column will be checked and an explanation is necessary. Comments may be provided by the inspector whether or not an item is deemed in need of repair

I=Inspected NI =Not Inspected NP=Not Present D=Deficiency

I	N	N	D	Inspection Item
	I	P		

conditions such as leaking drains/water supply lines ect.

The main water supply valve on the right side of the structure could not be closed under normal conditions. Recommend repair/replacing.



The water supply lines are not properly insulated in all areas of the attic space. Recommend adding insulation.



The main water supply line & the sprinkler system supply line on the right side of the structure has missing/damaged insulation. Recommend insulating.

Additional pages may be attached to this report. Read them very carefully. This report may not be complete without the attachments. If an item is present in the property but is not inspected, the "NI" column will be checked and an explanation is necessary. Comments may be provided by the inspector whether or not an item is deemed in need of repair

I=Inspected NI =Not Inspected NP=Not Present D=Deficiency

I	N	N	D	Inspection Item
	I	P		



Sinks:

Sinks are functioning as intended however there were deficiencies as described below.

- Drain stop in the jack & jill bathroom is missing.

Bathtubs/showers:

Bathtubs/showers are functioning as intended however there were deficiencies as described below.

Access panels are not installed to inspect the equipment/plumbing under the tubs/showers.

- The water supply valve handle at the bathtub in the upstairs ensuite bathroom is not properly secured & came off when attempting to open/closed the valve. Recommend repair.



Additional pages may be attached to this report. Read them very carefully. This report may not be complete without the attachments. If an item is present in the property but is not inspected, the "NI" column will be checked and an explanation is necessary. Comments may be provided by the inspector whether or not an item is deemed in need of repair

I=Inspected NI =Not Inspected NP=Not Present D=Deficiency

I	N	N	D	Inspection Item
	I	P		

Commodes:

Commodes are functioning as intended however there were deficiencies as described below.

The commode in the master bath does not have the required 15" clearance to the center of the commode as required by today's standards.

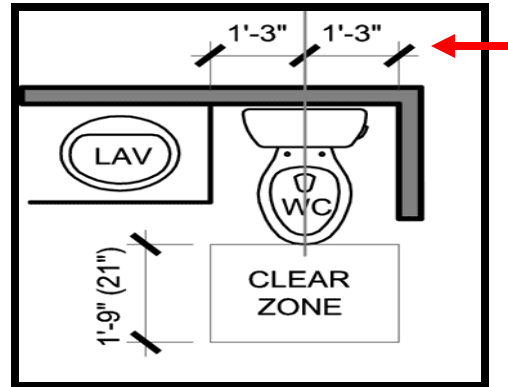

Outside Hose Bibs:

Hose bibs are functioning as intended however there were deficiencies as described below.

Back flow preventers are not installed on all hose bibs. Recommend installing to prevent water from backing up into the water system.

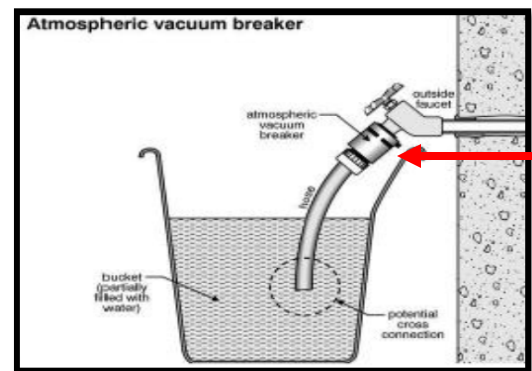

B. Drains, Wastes & Vents

Comments:

Additional pages may be attached to this report. Read them very carefully. This report may not be complete without the attachments. If an item is present in the property but is not inspected, the "NI" column will be checked and an explanation is necessary. Comments may be provided by the inspector whether or not an item is deemed in need of repair

I=Inspected NI =Not Inspected NP=Not Present D=Deficiency

I	N	N	D	Inspection Item
	I	P		

Water is run down the drains at the time of the inspection, however this cannot simulate the amount of flow that may take place during full occupancy. There may be some blockage of the drain lines from debris, broken pipes or tree roots that cannot be detected at the time of the inspection. Examination of such partial blockage is beyond the scope of this inspection.

Based on the inspection industry's definition of a recommended water test for "functional drainage" in a plumbing system, the plumbing drainpipes appeared operational at this time. However, only a video-scan of the interior of drainpipes and drain lines can fully confirm their actual condition. If the house is vacant, has an older plumbing system, if there are prior known drain problems or there are large trees around the structure, it would be prudent to have the drain lines "video-scanned" prior to closing.

It is recommended that any deficiencies/items of concern marked with a ☒ if any, are further evaluated/repaired/corrected by a licensed plumber prior to closing.

Appeared to be functioning as intended however there were deficiencies as described below.

☒ The wet bar sink & jack & jill bathtub are slow to drain.



☉ Observed what may possibly be microbial growth on the p-traps under the jack & jill bathroom sinks. Recommend cleaning.

Additional pages may be attached to this report. Read them very carefully. This report may not be complete without the attachments. If an item is present in the property but is not inspected, the "NI" column will be checked and an explanation is necessary. Comments may be provided by the inspector whether or not an item is deemed in need of repair

I=Inspected NI =Not Inspected NP=Not Present D=Deficiency

I	N	N	D	Inspection Item
I	P			

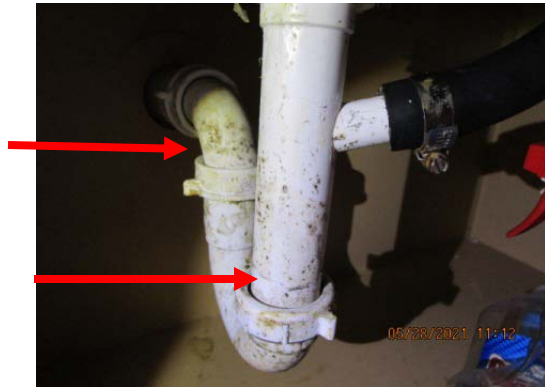

C. Water Heating Equipment

Energy Sources: Gas

Number of Water Heaters: 2



Additional pages may be attached to this report. Read them very carefully. This report may not be complete without the attachments. If an item is present in the property but is not inspected, the “NI” column will be checked and an explanation is necessary. Comments may be provided by the inspector whether or not an item is deemed in need of repair

I=Inspected NI =Not Inspected NP=Not Present D=Deficiency

I	N	N	D	Inspection Item
I	P			

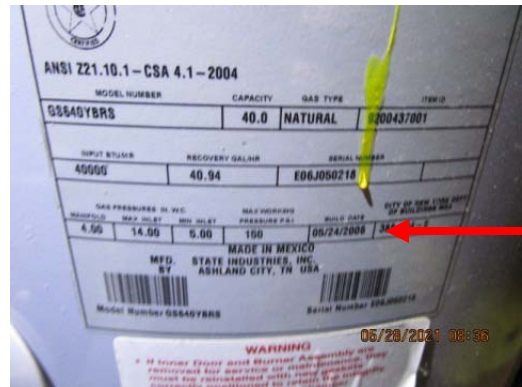
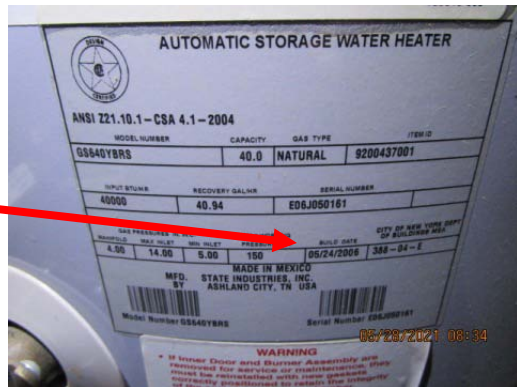

Capacities: 40 Gal. each

Ignition Sources: Electronic Ignition Pilot

Locations: Attic

Mfg: State

Mfg. Date/Dates: 2006 (both wtr heaters (According to the Manufacturer Label/Labels on the equipment at the time of the inspection);

Comments:

A water heater is equipped with a temperature & pressure relief (TPR) valve, (Temperature and Pressure Relief Valve, a safety valve installed on a hot water storage tank to limit the temperature and pressure of the water) This valve is visually inspected, however due to the likelihood that the valve would not reseat if discharged, & due to not being able to replicate the conditions required to determine whether or not the valve will function as intended these valves are not tested. TPR Valves are an important safety device that is required by most codes. Water heaters should be flushed every year or as recommended by the manufacturer to remove sediments that collect at the bottom of the tank. It is recommended that any deficiencies/items of concern, if any, are properly repaired/corrected by a licensed plumber prior to closing.

The inspector shall report the energy source, the capacity of the units. Report as Deficient inoperative units, leaking or corroded fittings or tanks, damaged or missing components, the absence of a cold water shut-off valve, if applicable, the absence of a pan or a pan drain system that does not terminate over a waste receptor or to the exterior of the building above the ground surface, inappropriate locations. The lack of protection from physical damage, burners, burner ignition devices or heating elements,

Additional pages may be attached to this report. Read them very carefully. This report may not be complete without the attachments. If an item is present in the property but is not inspected, the “NI” column will be checked and an explanation is necessary. Comments may be provided by the inspector whether or not an item is deemed in need of repair

I=Inspected NI =Not Inspected NP=Not Present D=Deficiency

I	N	N	D	Inspection Item
	I	P		

switches, or thermostats that are not a minimum of 18 inches above the lowest garage floor elevation, unless the unit is listed for garage floor installation. The absence of an opening that would allow access to equipment for inspection, service, repair or replacement without removing permanent construction or building finish. When applicable a floored passageway and service platform that would allow access for equipment inspection, service, repair or replacement. The absence of or deficiencies in the temperature and pressure relief valve and discharge piping, a temperature and pressure relief valve that failed to operate, when tested manually.

Requirements for gas units. The inspector shall report as Deficient gas leaks, flame impingement, uplifting flame, improper flame color, or excessive scale build-up. The absence of a gas shut-off valve within six feet of the appliance, the absence of a gas appliance connector or one that exceeds six feet in length. Gas appliance connectors that are concealed within or extended through walls, floors, partitions, ceilings or appliance housings. Deficiencies in combustion and dilution air, gas shut-off valves, access to a gas shutoff valves that prohibit full operation, gas appliance connector materials and vent pipe, draft hood, draft, proximity to combustibles, and vent termination point and clearances.

The right side water heating equipment was not in service at the time of the inspection. Multiple attempts were made to light the water heater however the water heater would not light under normal conditions. Recommend further evaluation/repair/replacement.



The left side water heating equipment is functioning as intended however there were deficiencies as described below.

TPR Valves are not manually tested due to the possibility of not being able to properly re-set the valve which would result in a leak in the system.

Additional pages may be attached to this report. Read them very carefully. This report may not be complete without the attachments. If an item is present in the property but is not inspected, the "NI" column will be checked and an explanation is necessary. Comments may be provided by the inspector whether or not an item is deemed in need of repair

I=Inspected NI =Not Inspected NP=Not Present D=Deficiency

I	N	N	D	Inspection Item
	I	P		

Water supply lines at the top of the left side water heater had oxidation/corrosion at the connections & a small active leak/water was observed at the left side connection. Recommend repair/replacing.

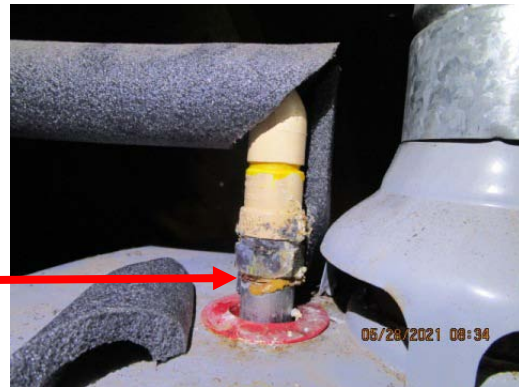

Water supply line at the top of the right side water heater had oxidation/corrosion at the connections. Recommend repair/replacing.



The TPR Valve drain lines do not terminate within 6" to grade. TPR Valve drain lines should terminate within 6" to grade and in a safe location to prevent the possibility of injury in the event the TPR Valve were to discharge.

The water heaters are potentially nearing the end of their life cycle. Recommend budgeting for replacement in the future.

D. Hydro- Massage Therapy Equipment

Additional pages may be attached to this report. Read them very carefully. This report may not be complete without the attachments. If an item is present in the property but is not inspected, the "NI" column will be checked and an explanation is necessary. Comments may be provided by the inspector whether or not an item is deemed in need of repair

I=Inspected NI =Not Inspected NP=Not Present D=Deficiency

I	N	N	D	Inspection Item
	I	P		

V. APPLIANCES

A. Dishwashers

Comments:

The inspector shall report as Deficient inoperative units, deficiencies in performance or mounting, rusted, missing or damaged components, the presence of active water leaks; and the absence of backflow prevention.

It is recommended that any deficiencies/items of concern marked with a if any, are further evaluated/repared/corrected by a qualified tradesman/contractor prior to closing.

The dishwasher was operated and allowed to run a complete wash cycle. The unit is functioning as intended.



The dishwasher had dishes in the wash basin which limits the visibility of & the possibility of detecting potential deficiencies.

B. Food Waste Disposers

Comments:

The inspector shall report as Deficient inoperative units, deficiencies in performance or mounting, missing or damaged components and the presence of active water leaks.

The food waste disposer was operated and is functioning as intended.

Additional pages may be attached to this report. Read them very carefully. This report may not be complete without the attachments. If an item is present in the property but is not inspected, the "NI" column will be checked and an explanation is necessary. Comments may be provided by the inspector whether or not an item is deemed in need of repair

I=Inspected NI =Not Inspected NP=Not Present D=Deficiency

I	N	N	D	Inspection Item
	I	P		



 Surface rust was observed on the interior of the disposal.

C. Range Hood & Exhaust Systems

Vent Method: Vented to the exterior through the microwave

Comments:

It is recommended that any deficiencies/items of concern marked with a if any, are further evaluated/repaired/corrected by a qualified tradesman/contractor prior to closing.

The range exhaust vent was operated and is functioning as intended.

 A rag was stuffed into the exhaust vent flap on the left side of the structure. Recommend removal.



Additional pages may be attached to this report. Read them very carefully. This report may not be complete without the attachments. If an item is present in the property but is not inspected, the "NI" column will be checked and an explanation is necessary. Comments may be provided by the inspector whether or not an item is deemed in need of repair

I=Inspected NI =Not Inspected NP=Not Present D=Deficiency

I	N	N	D	Inspection Item
I	P			

D. Ranges, Cook Tops & Ovens

Comments:

The inspector shall report as Deficient inoperative units, deficiencies in performance or mounting, missing or damaged components, ducts that do not terminate outside the building, if the unit is not of a re-circulating type or configuration and improper duct material.

The inspector shall report as Deficient inoperative units, missing or damaged components, combustible material within thirty inches above the cook top burners, absence of an anti-tip device, if applicable, gas leaks, the absence of a gas shutoff valve within six feet of the appliance, the absence of a gas appliance connector or one that exceeds six feet in length, gas appliance connectors that are concealed within or extended through walls, floors, partitions, ceilings or appliance housings and deficiencies in thermostat accuracy (within 25 degrees at a setting of 350° F). Mounting and performance, gas shut-off valves, access to a gas shutoff valves that prohibits full operation and as appliance connector materials.

It is recommended that any deficiencies/items of concern marked with a if any, are further evaluated/repared/corrected by a qualified tradesman/contractor prior to closing.

Cook Top: Gas

The cook top was operated and is functioning as intended however there were deficiencies as described below.



Random burners go out when turned to the low setting. Recommend that the burners be adjusted so the flames do not go out when set to the low setting.

Report Identification: 10815 Lake Raven Ct. Cypress, TX. 77433

Additional pages may be attached to this report. Read them very carefully. This report may not be complete without the attachments. If an item is present in the property but is not inspected, the "NI" column will be checked and an explanation is necessary. Comments may be provided by the inspector whether or not an item is deemed in need of repair

I=Inspected NI =Not Inspected NP=Not Present D=Deficiency

I	N	N	D	Inspection Item
	I	P		



Oven: Electric

The oven was operated and is functioning as intended.



The oven was turned on to 350 degrees and allowed to cycle through the preheat function, a temperature reading was performed and read 345 degrees, a variance of 25 degrees is considered acceptable.

Additional pages may be attached to this report. Read them very carefully. This report may not be complete without the attachments. If an item is present in the property but is not inspected, the "NI" column will be checked and an explanation is necessary. Comments may be provided by the inspector whether or not an item is deemed in need of repair

I=Inspected NI =Not Inspected NP=Not Present D=Deficiency

I	N	N	D	Inspection Item
	I	P		



E. Microwave Ovens

Comments:

The inspector shall inspect built-in units and report as Deficient inoperative units, deficiencies in performance or mounting and missing or damaged components.

It is recommended that any deficiencies/items of concern marked with a if any, are further evaluated/repared/corrected by a qualified tradesman/contractor prior to closing.

The microwave was operated and is functioning as intended.



F. Mechanical Exhaust Vents and Bathroom Heaters

Comments:

The inspector shall report as Deficient inoperative units, deficiencies in performance or mounting, missing or damaged components, ducts that do not terminate outside the

Additional pages may be attached to this report. Read them very carefully. This report may not be complete without the attachments. If an item is present in the property but is not inspected, the "NI" column will be checked and an explanation is necessary. Comments may be provided by the inspector whether or not an item is deemed in need of repair

I=Inspected NI =Not Inspected NP=Not Present D=Deficiency

I	N	N	D	Inspection Item
I	P			

building and a gas heater that is not vented to the exterior of the building unless the unit is listed as an unvented type.

It is recommended that any deficiencies/items of concern marked with a if any, are further evaluated/repared/corrected by a qualified tradesman/contractor prior to closing.

The exhaust vents are functioning as intended.

G. Garage Doors, Operators

Comments:

Garage doors, including automatic openers and safety devices, are inspected to determine if they are functioning properly.

Openings between the garage and residence shall be equipped with solid wood doors not less than 1 3/8 inch (35 mm) in thickness, solid or honeycomb core steel doors not less than 1 3/8 inches (35 mm) thick, or 20-minute fire-rated doors.

The garage door is typically the largest moving object in the house, and many of its components are under high tension. Improper installation or maintenance of a garage door can create a hazardous condition that can cause serious injury or even death. If a spring is broken, operating the door can cause serious injury or death.

Do not operate the door until the spring is replaced by a trained door systems technician. Because of potential dangers involved, all repairs and adjustments must be performed by a trained door systems technician using proper tools and instructions.

A moving door can cause serious injury or death. Keep people clear of the opening while the door is moving.

High spring tension can cause serious injury or death. Do not try to remove, repair or adjust springs or anything to which door spring parts are fastened, such as, wood blocks, steel brackets, cables or other like items.

If/when a garage door operator is installed door manufacture's require additional bracing at top of door to be installed to prevent damage to door from automatic opener.

Additional pages may be attached to this report. Read them very carefully. This report may not be complete without the attachments. If an item is present in the property but is not inspected, the “NI” column will be checked and an explanation is necessary. Comments may be provided by the inspector whether or not an item is deemed in need of repair

I=Inspected NI =Not Inspected NP=Not Present D=Deficiency

I	N	N	D	Inspection Item
	I	P		



The inspector shall report as Deficient inoperative units, deficiencies in performance or mounting, missing or damaged components, installed photoelectric sensors located more than six inches above the garage floor and door locks or side ropes that have not been removed or disabled.

It is recommended that any deficiencies/items of concern marked with a if any, are further evaluated/repared/corrected by a qualified tradesman/contractor prior to closing.

Garage doors are functioning as intended however there were deficiencies as described below.

Automatic door opener openers were not present at the time of the inspection.

The two car garage door is missing the bottom roller on the right side of the door. Recommend replacing.



Additional pages may be attached to this report. Read them very carefully. This report may not be complete without the attachments. If an item is present in the property but is not inspected, the "NI" column will be checked and an explanation is necessary. Comments may be provided by the inspector whether or not an item is deemed in need of repair

I=Inspected NI =Not Inspected NP=Not Present D=Deficiency

I	N	N	D	Inspection Item
	I	P		

H. Dryer Exhaust Systems

Comments:

This was a limited visual inspection due to a large portion of the dryer vent is hidden behind walls/between floors & the dryer ducts may not be able to be checked for cleanliness. Dryer ducts should be checked/cleaned on a regular basis.

The inspector shall report as Deficient missing or damaged components, the absence of a dryer exhaust system when provisions are present for a dryer. Ducts that do not terminate to the outside of the building, screened terminations and ducts that are not made of metal with a smooth interior finish.

It is recommended that any deficiencies/items of concern marked with a if any, are further evaluated/repaired/corrected by a qualified tradesman/contractor prior to closing.

The dryer vent appeared to be functioning as intended however there were deficiencies as described below.

The dryer vent is terminated into the garage & not to the exterior as required. By today's standards



Dryer vent is dirty/filled with dryer lint. This is a potential fire hazard & should be properly cleaned.

Additional pages may be attached to this report. Read them very carefully. This report may not be complete without the attachments. If an item is present in the property but is not inspected, the "NI" column will be checked and an explanation is necessary. Comments may be provided by the inspector whether or not an item is deemed in need of repair

I=Inspected NI =Not Inspected NP=Not Present D=Deficiency

I	N	N	D	Inspection Item
	I	P		



VI. OPTIONAL SYSTEMS

- A. Landscape Irrigation (Sprinkler) Systems**

Comments:

This was a limited visual inspection due to a large portion of the system is hidden underground/behind vegetations & may not be visible at the time of the inspection.

The inspector shall: Manually operate all zones or stations on the system through the controller;

Report as Deficient: The absence of a rain or moisture sensor, inoperative zones/valves; Surface water leaks; The absence of a backflow prevention device; The absence of shut-off valves between the water meter and backflow device; Deficiencies in the performance and mounting of the controller; Missing or damaged components; and deficiencies in the performance of the water emission devices; Such as, sprayer heads, rotary sprinkler heads, bubblers or drip lines.

The inspector is not required to inspect: For effective coverage of the irrigation system; The automatic function of the controller; The effectiveness of the sensors; such as, rain, moisture, wind, flow or freeze sensors; or sizing and effectiveness of backflow prevention device.

It is recommended that any deficiencies/items of concern marked with a if any, are further evaluated/repaired/corrected by a qualified tradesman/contractor prior to closing.

The sprinkler system consisted of zones & was operated using manual controls only. The system was operated in the manual mode only & appeared to be functioning as intended however this was a limited inspection due to vegetation limiting the line of site for some spray

Additional pages may be attached to this report. Read them very carefully. This report may not be complete without the attachments. If an item is present in the property but is not inspected, the "NI" column will be checked and an explanation is necessary. Comments may be provided by the inspector whether or not an item is deemed in need of repair

I=Inspected NI =Not Inspected NP=Not Present D=Deficiency

I	N	N	D	Inspection Item
I	P			

heads & there were deficiencies as described below. The system was not checked using the automatic timer. Sprinkler systems should be checked on a regular basis to ensure water is not being sprayed against the structure.

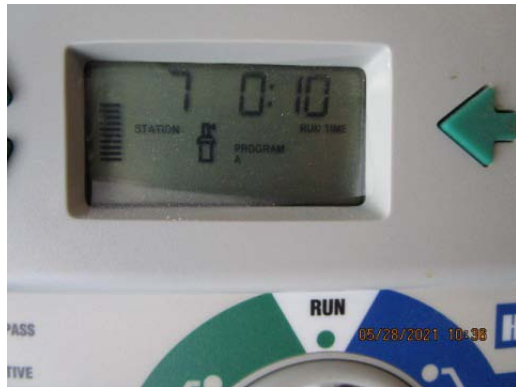

The system does not have a visible moisture sensor installed to shut the system down when excessive moisture is detected. Recommend further evaluation/repair.

 The inspector was unable to locate the main shut off for the system. Recommend consulting with the seller for the location.

B. Gas Supply Systems

Comments:

This was a limited visual inspection due to a large portion of the Gas Supply System is hidden behind walls & insulation & was not accessible/visible.

It is recommended that any deficiencies/items of concern marked with a if any, are further evaluated/repared/corrected by a qualified tradesman/contractor prior to closing.

Gas Line: Black Iron (where visible)

Appeared to be functioning as intended.