

HARBORWALK

A COASTAL LIFESTYLE COMMUNITY ON WEST BAY

Harborwalk Property Owners Association
Development Review Committee
Builder Guidelines



REVISION 8-2016.07.29 is a compilation of previous revisions and amendments including the SIXTH AMENDMENT (Rev. 8-9-2013), the SEVENTH AMENDMENT (Filed and Recorded 9-1-2014) and the EIGHTH AMENDMENT (Adopted 7-29-2016; Filed and Recorded 8-8-2016).

This document shall be in effect as of September 1, 2016.

Table of Contents

FREQUENTLY ASKED QUESTIONS	1
1.0 INTRODUCTION	2
2.0 CONSTRUCTION PROCEDURES	
2.1 Other Permits / Requirements	3
2.2 Containment of Debris & Construction Noise	4
2.3 Variances	5
2.4 Signage	6
2.5 Inspections & Enforcement	7
3.0 SITE LAYOUT	
3.1 Building Setbacks	8
3.2 Lot Coverage	9
3.3 Walkways	10
3.4 Driveways	11
3.5 Pools and Spas	13
3.6 Playscapes, Swing Sets, and Flagpoles	14
3.7 Fences	15
3.8 Boathouses, Docks & Piers	16
3.9 Boathouses & Docks at Water Key	18
3.10 Bayfront Piers at Water Key	19
3.11 Boathouses at Sugarloaf	20
3.12 Fish Cleaning Tables	21
3.13 Bulkheads	22
4.0 ARCHITECTURE	
4.1 General Architecture	23
4.2 Exterior Materials	24
Approved Colors – Paint	25
Approved Colors – Paint (Trim/Accent Only)	29
Approved Colors – Roof	30
4.3 Elevated Construction	31
4.4 Equipment Platforms Elevators & Lifts	32
4.5 Entrances, Windows & Address Signage	33
4.6 Roofs & Rooftop Elements	34
4.7 Solar Energy Devices	35
4.8 Garages	36
4.9 Square Foot Requirements & Maximum Heights	37
4.10 Porches	38

Table of Contents

5.0 LANDSCAPE		
5.1	General Landscape	39
5.2	Lighting	40
5.3	Residential Landscaping	41
5.4	Minimum Landscape Requirements	42
5.5	Landscaping at Water Key Boathouse Easements	43
5.6	Prohibited Plant Materials	44
5.7	Landscape Maintenance	45
5.8	Grading Foundations & Sediment Control	46
5.9	Irrigation	47
6.0 DRC SUBMISSION AND APPROVAL		
6.1	General Plan Submittal Information	48
6.2	Builder Guidelines	49
6.3	Recommendations for Construction	50
6.4	Final DRC Inspection	51
6.5	Custom Home Submittal Information	52
	Custom Plan Submittal Form	53
	Modification Submittal Form	54
6.6	Production Home Submittal Information	55
	Production Plan Submittal Form	56
	Production Lot Submittal Form	57
	Modification Submittal Form	58
6.7	Home Maintenance Work	59
	Home Maintenance Submittal Form	60

What is the purpose of the Builder Guidelines and / or the DRC?

The Builder Guidelines are intended to establish minimum aesthetic standards for all homes constructed in the Harborwalk community. These standards are intended to protect the quality of life for all residents and the value of all the homes in the community. The Builder Guidelines are not intended to create or enforce safety or engineering standards that are already addressed by the City of Hitchcock building code.

The Development Review Committee (DRC) of the Harborwalk Property Owners Association is responsible for ensuring that all home construction within the community is in accordance with the Builder Guidelines and the Protective Covenants, including new construction, additions, remodels, and any other construction activity.

What do I need to do before starting construction on my home?

All plans must receive approval from the DRC, and you must also obtain a building permit from the City of Hitchcock. The DRC also recommends that you have a registered surveyor perform the piling layout before starting construction. Lot owners are required to also make application with the Flamingo Isles Municipal Utility District (MUD) 60 days prior to any construction.

What do I need to do before making any changes to the exterior of my home? For routine maintenance?

If a property owner is simply doing routine maintenance such as repainting (same colors), replacing rotted wood, fixing broken louvers, etc. (I.E. not changing anything but simply maintaining it), then no approval is needed. The DRC should be notified of what work is planned and time frame for completion. However, if any changes are to be made, by either replacing, changing, or adding to any part of the exterior of the residence, those changes must be submitted for approval before any work is done.

What are the procedures for DRC approval?

The DRC encourages lot owners to submit the design review package detailed in Section 6.5. This allows the DRC to ensure the plan concept complies with the Builder Guidelines before you embark on more detailed construction drawings. Making changes after the construction drawings and engineering are completed can be much costlier.

Once preliminary approval is obtained you can complete the construction drawings and submit the final design package for final approval. It is acceptable to submit color selections and landscape plans at a later date since these decisions are often made later in the construction process. However, approval must be received prior to installation of these components.

All homes are also required to have a final DRC inspection (see Section 6.4) to ensure the home complies with the approved plans and/or Builder Guidelines.

What about getting a City of Hitchcock building permit?

Construction of your new home will require you to get a building permit from the City, pass certain inspections by the City Building Inspector during the construction of the home, and get a Certificate of Occupancy when your home is complete.

The City of Hitchcock is also responsible for enforcing the building restrictions set forth in FEMA’s National Flood Insurance Program restrictions on building.

For more information, call the City of Hitchcock Building Department at (409) 986-5591.

Why is it recommended to have a surveyor lay out my piling?

The curved boundary lines on many of the lots in Harborwalk make the geometry of laying out your new home much more complex than on a rectangular lot. Having the layout done properly keeps you from accidentally encroaching on a building setback line. Fixing these encroachments once the pilings are in place becomes very expensive.

Often a “form survey” is performed to verify forms are placed correctly before installing concrete, but since piling and/or/ sub-piling are usually driven before any forms are set in elevated construction costly mistakes are often made before “forms” are actually placed.

What do I need to know about designing my home around the bulkhead system?

All building setback areas adjacent to bulkheads are intended to limit loading on the bulkhead system in addition to preserving view windows. For that reason, no excessive fill or vertical construction is allowed in these setback areas.

It is also important to note that the subsurface bulkhead tieback system often extends under the allowable building footprint. Contact the Flamingo Isles Municipal Utility District (MUD) to get piling and tieback locations so you can design a foundation system that does not interfere with the bulkhead system at your lot.

Harborwalk is being developed as a master planned community. Some of the possible features include a semi-private member club with swimming pools, tennis courts, sport courts, and food service, hike & bike trails, landscape reserves, a hierarchy of internal street rights of way, standard single family detached residences on varied lot sizes, multi-family apartments and/or condominiums and cottages, townhouses, cluster homes, commercial/office space, a commercial marina and a ship store and fuel dock.

The master plan illustrates land uses for the intended development. The developer reserves the right to make alterations to the general plan and product types as development progresses.

This document is presented as a minimum set of development guidelines and standards for the Harborwalk community. The intended use is to provide a framework to illustrate and define design objectives for a unified, harmonious setting for the diverse enterprises and styles inherent in a multi-use land development. When conflicts exist within these guidelines the higher and better standard shall prevail.

These guidelines are supplemental to the Protective Covenants and are to be used in architectural review of builder, developer or owner plans. If a conflict exists between these guidelines and the Protective Covenants, the Protective Covenants shall prevail. Non-compliance with these guidelines is grounds for disapproval of plans. These guidelines are also for use as standards for future compliance to maintain the integrity of the community, as well as the preservation and enhancement of property values.

Location, size, style, color and types of signs, buildings, walls, sidewalks, vegetation, ornaments, grading, parking and other design elements are described in the following pages. Illustrative examples and descriptions are meant to ensure an orderly and well-maintained sense of place and community.

These guidelines are created to enhance the investment in property and to provide an attractive environment for people living, working, shopping and involved in recreational pursuits in the Harborwalk community.

These guidelines are expected to be updated from time to time in order to clarify the standards and/or to address issues and questions that arise. These revisions may be issued in letter form, as revised pages to replace pages in the existing book, or as a complete re-stated book.

To the extent that any provisions of this policy are held to be invalid, illegal, unenforceable or in conflict with any provision of applicable law, the validity, legality and enforceability of the remaining provisions shall not in any way be affected or impaired thereby.

The DRC's primary focus is enforcing the restrictions established in the Builder Guidelines and the Protective Covenants. It is the responsibility of the builder/owner to comply with any and all requirements that may be in effect from the City of Hitchcock, Galveston County, FEMA's NFIP, the EPA, the Flamingo Isles MUD, or any other governmental or municipal entity.

For information regarding City of Hitchcock requirements you should contact the City Building Department at (409) 986-5591.

For additional information on the National Flood Insurance Program administered by FEMA visit www.floodsmart.gov.

The Environmental Protection Agency's (EPA) National Pollutant Discharge Elimination System (NPDES) requires a Storm Water Pollution Prevention Plan for many construction and development activities. Harborwalk Development Company has a SWPPP in place during each phase of infrastructure development. It is important to note that these plans and permits do not cover any action taken by lot owners and/or home builders.

The DRC does not offer an opinion regarding the need for individual home construction projects to have a SWPPP under the current EPA regulations, and does not undertake any responsibility to ensure compliance with environmental laws by home builders. It is the responsibility of individual property owners and/or builders to ensure they comply with whatever current regulations are in place. For more information visit www.epa.gov/npdes.

Most lots contain underground obstructions within the allowable building footprint. Deadmen and tie backs along the bulkheads must be field verified by the Flamingo Isles MUD engineer prior to any construction.

Once construction begins on a new residence, that construction must be completed within twenty-four (24) months.

When a boathouse or pier is constructed before construction on the residence begins, construction on the residence must commence within twenty-four (24) months.

All homebuilding activity generates considerable noise concerns as well as construction debris and other trash during the construction process. While all communities with construction activity must deal with the collection and containment of this material the unique situation at Harborwalk requires extraordinary efforts by builders regarding construction debris.

In order to deal with excessive construction noise concerns by existing homeowners, construction shall not begin before 6:00 a.m. and must conclude by sundown on weekdays. On Saturdays, construction may not begin before 8 am and must conclude by sundown, and shall not include excessive noise such as pile driving. Sundown is defined as when the sun is no longer visible in the sky. No construction shall be allowed on Sundays. "Quiet work" may be done at any time once the structure has been closed in. Pouring of major foundations may begin earlier to avoid excessive daytime heat, but must be approved in writing by the POA. Emergency Work may be done at any time once a home is occupied.

The lots at Harborwalk are extremely open with a few shrubs or trees to catch and block debris before entering neighboring lots, and the wind on the coast is often brisker than typically found at inland communities. Coupled with the fact that the lots in Harborwalk are all connected to waterways that are part of the Galveston Bay Estuary, it is important that the property owners and builders are diligent about controlling trash and construction debris.

In order to address the problems encountered the DRC has promulgated certain rules regarding containment of construction debris and cleaning of jobsites.

All homes under construction are required to contain construction debris and other jobsite trash. The recommended option is a roll-off dumpster from the then current vendor under the City of Hitchcock waste management services agreement.

Portable restrooms shall be anchored to prevent being turned over by typical high winds.

All homes under construction are also required to install and maintain a webbed "construction fence" on all sides of the lot except for the street side to keep debris from blowing onto neighboring lots or into canals. Homes undergoing considerable remodel or repair may also be

required to maintain a webbed "construction fence" on all sides as may be determined by the DRC.

In addition to the "construction fence" a silt fence is required to be installed and maintained along all property lines that abut a bulkhead to prevent sand and fill material from entering the canals. This fabric silt fence should return alongside property lines ten feet (10') from the property corner at the bulkhead. See Section 5.8 Grading & Sediment Control for more information.

Builders should take care to keep all debris in the dumpster or containment bin. In particular, builders shall clean their job site each Friday at the end of the workweek. All dumpsters must be covered when site is unattended.

Section 10.05 of the Protective Covenants requires that construction sites be kept free of unsightly accumulations of rubbish and scrap material. This section also states that "no accumulation or storage of litter or trash of any kind shall be permitted."

In the event the POA or DRC discovers jobsites in violation of this Section or Section 2.4, the builder will be given 14 days after notification to correct the violation. However, on specific violations including debris in canals, overturned Porta-potty, mud on street and overflowing dumpsters, builder shall have 24 hours after notification to correct the violation. The cost of cleaning shall become a personal obligation of the Owner under Section 8.01 of the Protective Covenants. If violation is not cured within this time period, the POA shall contract to correct the issue using compliance deposit funds.

Parking within Harborwalk during construction is challenging. Builders should be respectful of all residents of Harborwalk. Parking should be limited to one side of the street, and does not include parking on empty lots. Roadways must always remain clear to allow free flow of traffic at all times. All construction materials and tools must be kept within the tract where the construction is taking place.

These Builder Guidelines are intended to be applied fairly and equally. In general, the DRC does not grant variances allowing construction to vary from the Builder Guidelines.

Due to the complexity of laying out the foundation adjacent to curved setback lines the DRC highly recommends the use of a registered surveyor for the initial layout to ensure the construction does not encroach on building setback areas.

The DRC may grant variances for encroachments due to construction errors that are not discovered until after the structure in question is complete. These “construction tolerances” are up to six inches for land based structures, and up to twelve inches for piers and/or bulkhead built over water.

These variances are intended only for relief from construction mistakes, and no variance will be granted allowing the design of a structure that encroaches on the setback areas.

Specific requirements and guidelines for signage are intended to limit the amount of signs, to present an image of quality, and to squelch the propensity of competing builders to “outdo” each other in attracting home buyers with signage.

The developer and DRC acknowledge that directional and informational signs are a necessary part of a growing development. In an effort to preserve the consistent, orderly aesthetics of the neighborhood, all signage required for these purposes will be supplied by the developer, and will adhere to consistent design standards, sizes, and colors.

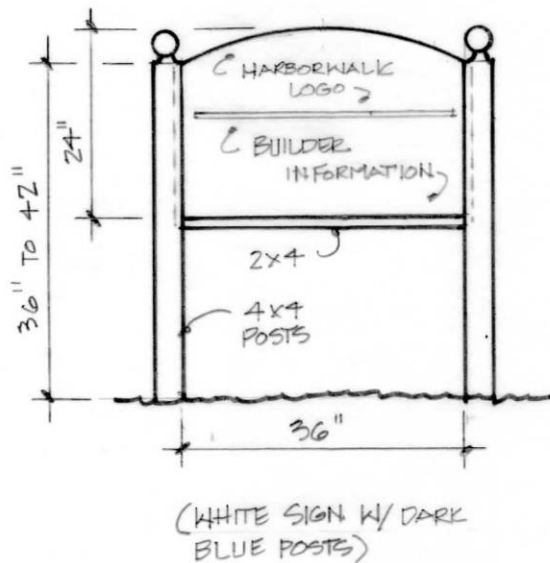

In accordance with Section 13.05 of the Protective Covenants, each builder may place one sign at each single family home under construction. These signs are intended to make tradesmen and material deliverymen aware of the address and builder when they are attempting to find a jobsite, and to provide contact information for neighboring residents in the event they need to contact the builder.

This sign should conform to the subdivision standard (see sketch) and should convey the name and phone number of the builder. Builder signs will be paid for by Builder.

No signs will be allowed on vacant lots. Signs may not be installed more than 21 days before construction begins, and must be removed no more than 21 days after a Certificate of Occupancy has been issued for the home.

The Harborwalk logo and logotype is trademarked by the developer, and is permitted for use only at Builder signs. All other uses must be approved in writing by the developer. Please verify the exact logo required before having signs made.

Inspections of Construction Sites will be performed on a regular basis. When a compliance issue is discovered, the builder and homeowner will be notified via email and provided a date when the issue needs to be resolved, 14 days from the date of notification. If no email address is available, a letter will be sent with the date of post-mark considered to be the date of notification.

When a compliance issue is not taken care of after the first notification within the time period provided, the POA, upon recommendation and notice from the DRC, will send a Non-Compliance Enforcement Notice to the builder indicating the following:

- Description of the compliance issue, and copy/date of the first notice
- A reasonable deadline to have the issue resolved or to apply for a variance
- Notification of continued compliance issue will result in:
 - No final approval to the builder or the City of Hitchcock Permitting Office.
 - No approvals or processing of other applications on any other projects in the community.
 - Builder will lose Approved Builder status within Harborwalk and will not be allowed to perform any additional projects within the POA.
 - Possible imposition of penalties for construction violations.

A Construction Violation Penalty Schedule has been implemented for construction site that fall out of compliance and fail to correct the issue(s) within a timely manner. Penalty Fees will be deducted from the compliance deposit.

Fee Schedule is available from the Association Management Office.

Building setbacks areas will be as shown on the recorded plat. No vertical construction is to be built in any of the setback areas, including, but not limited to, houses, garages, gazebos, trellises, lifts or davits for personal watercraft, fish cleaning tables (other than described in Section 3.12) or storage closets (other than described in Section 3.9), flagpoles, play equipment, or other above ground structures.

When proposed residence touches building setback lines at multiple points, DRC recommends the use of a surveyor to locate all pilings. Ground level decks and patios are allowed, but when they are located in an easement area they are subject to removal by the utility companies and/or MUD at the expense of the homeowner. No more than six inches of fill may be placed in setback areas, with the exception of planting beds along the foundation. These beds may not extend above the elevation at the edge of the street in front of the lot. Steps may be built from the foundation level down to grade level, but may not extend into drainage easements. Freestanding boat lifts with low roofs are allowed within or adjacent to setback areas as described in Section 3.8 and in accordance with the location restrictions on the recorded plat.

Where setback areas are adjacent to canals and the setback line is at least fifteen feet (15') from the property line porches and decks may cantilever over the setback line up to two feet (2'). No piling may be placed in the setback area to support the porch, and solid walls, including "boxed out" windows or other projections, may not cantilever over the setback line. Roof eaves may overhang setback areas up to three feet (3'). Balconies and other structures may not overhang front setback lines, or any side setback line not adjacent to a canal as described above.

In selected areas, the minimum side yard setbacks may be greater than usual on either side of staggered lot lines, in order to create view windows. No vertical construction may be built in these view windows to preserve sight lines.

Lot coverage is identified at the area covered by buildings, driveways, patios, pools, spas, decks, and other structures. All lots (including paving) must drain toward the canal. Nothing shall be allowed to drain toward the street.

A limit on lot coverage is necessary in order to preserve an adequate amount of open space and landscaped area throughout the community, as well as maintain the desired character of the community.

Lot coverage shall not exceed seventy percent (70%) on any lot, meaning that at least thirty percent (30%) of the surface area of the lot should be maintained as lawn or landscaped area.

The use of “Grasscrete” or similar paving blocks that allow the growth of lawn in voids in the paving is allowed to create parking or turn-around area. These areas will count as lot coverage for purposes of this section 3.2, but will not count toward the allowable driveway dimensions described in Section 3.4.

Walkways should be a complementary component of the site architecture and should not compete visually with the house and/or landscape.

- A walkway at least three feet (3') in width and no more than six feet (6') in width shall be provided from the front door of the residence to the street curb or the driveway. In addition, a broad landing, not to exceed the width of the porch, will be allowed at the front door.
- Walkways are encouraged to be constructed with brick, quarried stone, interlocking pavers, stamped concrete or concrete. The use of alternate materials shall require the approval of the DRC. Asphalt walkways are prohibited.
- In those instances, where a walkway closely parallels the front wall of a house, a planting area (minimum 4' in width) must be maintained between the house and walkway.
- Steps at elevation change are required on walkway slopes exceeding four percent (4%).
- Fountains and statuary within the walk and front yard and meandering walkways require DRC approval.

Sidewalks are only included along "collector" streets and are built and maintained by the developer and/or the POA.

At Water Key boathouse easements, all walkways, patios, & other hardscaping are encouraged to be constructed with brick, quarried stone, interlocking pavers, or stamped concrete. The use of any alternative material shall require DRC approval. Asphalt is prohibited. Hardscape coverage at easements is limited to 65% maximum including drive. Refer to Section 3.9 Boathouses & Docks at Water Key for more information.

Builders are required to build the driveway into the street right-of-way.

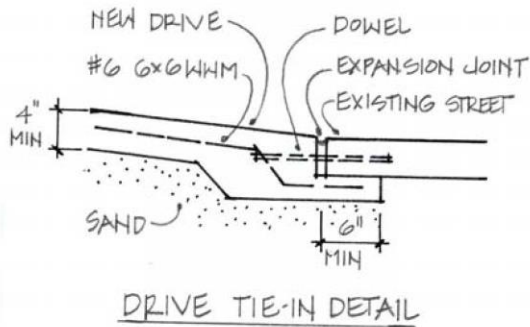

All driveways are to be constructed of concrete, and should be a minimum of four inches (4") thick over a sand base. Expansion joints between the curb or street and driveway are required as illustrated. A thickened 'beam' shall be located at the end of driveways adjacent to the street, and shall extend under the street a minimum of six inches (6") to prevent settling at the street. Construction and reinforcement of all driveways is to meet or exceed City of Hitchcock standards.

Driveways must cross the building setback area in a straight line and perpendicular to the street right-of-way. Driveways should be set back at least two feet (2') from the side property line.

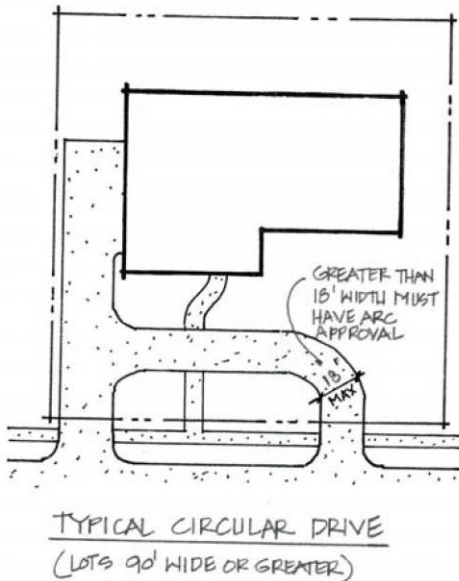

Turnaround or circular drives are not allowed except on lots having widths of ninety feet (90') or greater (measured at the front property line). No turnaround or circular driveways will be permitted on corner lots. Under no circumstance may an entire front yard be paved as a driveway. The turnaround portion may not be wider than eighteen feet (18') without DRC approval.

On lots narrower than ninety feet (90') with two separate garage entrances an area between the entrances may be filled with "Grasscrete" or similar paving blocks that allow the growth of lawn in void areas. This area will not count toward the driveway width.

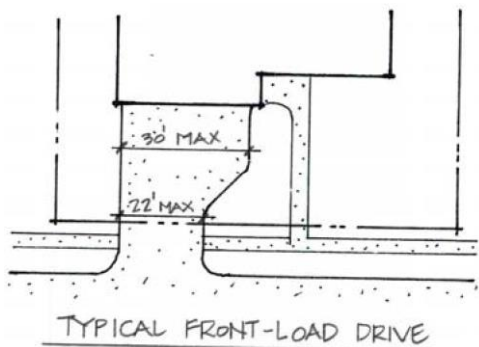

Driveways serving front-loaded garages shall be no greater in width than twenty-two feet (22') where they cross the front property line, and may flare past the property line to a maximum width of thirty feet (30').

Driveways serving side-loaded garages must be a minimum width of ten feet (10') and a maximum width of twenty-two feet (22') where they cross the front property line, and may then flare to the width needed at the garage.

Driveways serving side-loaded garages on corner lots, where drive exits lot on the side street, may be a maximum width of twenty-two feet (22') and five feet (5') beyond the side property line.

Driveways may be the width of the overhead doors located side by side, but must be submitted for approval.

Driveways should not be constructed over inlets or manholes. In instances where this may be unavoidable, compliance with City regulations that may require inlet adjustment and/or upgrade may be necessary.

The use of decorative driveways to enhance the appearance of the home is required. The use of stamped and/or colored concrete over the entire driveway, paverstone or similar interlocking pavers over a base of concrete or cement stabilized sand, concrete panels with brick borders, or exposed aggregate concrete paving is encouraged.

As a minimum standard for decorative driveways, regular concrete may be used, but must contain a tooled or saw cut joint every five feet in either direction to break up the expanse of concrete (see sketch).

If adjacent lot is re-platted as part of main lot, additional drive areas will require DRC approval.

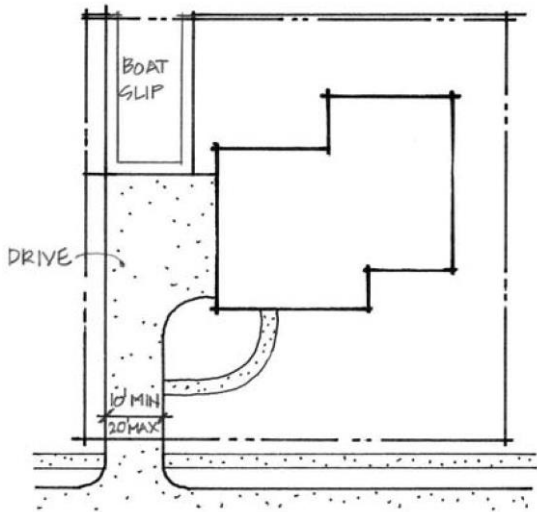

TYPICAL SIDE-LOADED DRIVE

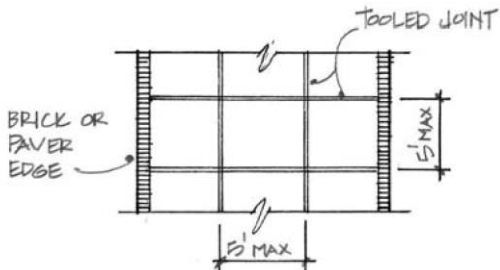

DRIVEWAY PAVING DETAIL

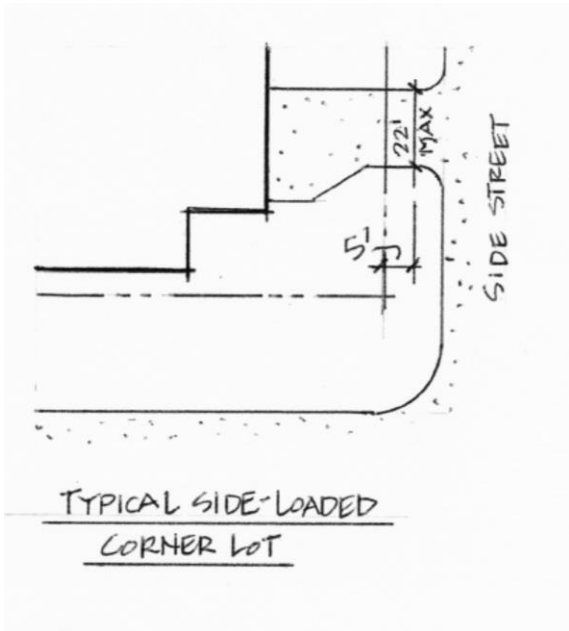

TYPICAL SIDE-LOADED CORNER LOT

Pools may not be installed without an adjacent residential structure whether on the same lot, or on the neighboring lot owned by the same Owner. Pools installation may begin prior to the construction of a residential structure for ease of access, but may not be completed until the residential structure is completed.

Portable or permanent above ground swimming pools are prohibited. Smaller prefabricated, installed above the ground, spas or hot tubs are acceptable. Above ground spas or hot tubs that are visible from public view or from other lots must be skirted, decked, screened or landscaped to hide all plumbing, heaters, pumps, filters, etc.

Privacy screening for pools or spas on canal or bay lots must be provided entirely through landscaping. Fences or walls in compliance with the Specifications in Section 3.7 will be allowed with DRC approval.

Swimming pool appurtenances such as rock waterfalls and sliding boards must be submitted for approval regardless of requested height. Skimmer nets, long handle brushes, pool chemicals, filters, pumps, heaters, plumbing, etc. must be located or stored so as not to be visible from public view. Pool utility equipment must be screened from the front to rear.

Pool walls shall not encroach on utility or drainage easements. If pool plumbing is required in utility easements, contact the proper utility coordinating agencies and the City of Hitchcock before digging. Wood or concrete pool decks may be placed on utility easements, but are subject to removal by utility companies at the expense of the homeowner.

Pool walls may encroach into the fifteen foot (15') rear setback areas up to the five foot (5') easement along the bulkhead. Care should be taken to design around subsurface components of the bulkhead system that may be located outside of the setback areas. Pool design and engineering MUST be coordinated with the Flamingo Isle Municipal District (MUD). If any damage occurs to the existing bulkhead tie-back system, property owner will be responsible for repairs.

Application must be made to the Flamingo Isle Municipal Utility District (MUD) for information about deadmen and tiebacks on your specific lot 60 days prior to construction.

Pool decks should be no higher than edge of the street in front of the lot. Pool decks may extend into setback areas not adjacent to bulkheads, but no walls, pool appurtenances or other structures that extend higher than the edge of the street in front of the lot may occur in setback areas. Pool decks may not extend into drainage easements as set forth on the recorded plat.

Individual playscapes or swing sets are allowed at back and side yards, as long as they do not encroach on the building setback areas.

Play equipment should be manufactured from treated pine, cedar, redwood, or powder coated steel. High impact plastic components such as slides and ladders are acceptable.

Temporary event or play equipment of any size will be allowed for weekend or special occasion parties only and then must be promptly removed.

All permanent seating benches and/or retaining walls within the rear building setbacks to be submitted for approval.

Freestanding flagpoles are not allowed at individual residences, but homeowners may fly a maximum of two flags from flagpoles attached to their house. Only United States and official state flags of US states may be flown provided full compliance with all of the requirements set forth herein. An owner or resident wishing to install any flag other than those permitted, or to install a flag in a manner which deviates from the requirements set forth herein, may not do so unless and until the owner or resident has secured the prior written approval of the DRC.

No flag displayed may be more than three feet (3') in height by five feet (5') in width (3'x5').

The flag of the United States of America must be displayed in accordance with 4 U.S. C. Sections 5-10 and the flag of the State of Texas must be displayed in accordance with Chapter 3100 of the Texas Government Code.

Any flagpole attached to a house must be constructed of permanent, long-lasting materials, with a finish appropriate to the materials used in the construction of the flagpole and harmonious with the dwelling.

A displayed flag and the flagpole on which it is flown must be maintained in good condition. Any deteriorated flag, or deteriorated or structurally unsafe flagpole must be promptly repaired, replaced, or removed.

Any flag may be illuminated by no more than one (1) halogen landscaping light of low beam intensity which shall not be aimed towards or directly affect any neighboring property.

Fences are not required, but if a homeowner desires a fence it must conform to the guidelines set forth below. A consistent fence standard has been established so the color and style do not vary if adjoining lots on either side of a property elect to both install a fence. All fences should be white vinyl closed picket style (Bufftech “Baron” by Certainteed or equal). Additionally, two (2) rail, smooth top, powder coated, black or white, aluminum fencing is allowed. All fencing must be approved prior to installation.

Fences are only to be constructed of vinyl or aluminum pickets. All bents are to be a maximum of eight feet (8') wide, and the fence height should be four feet (4'). The fence is to be installed using quality materials and standard construction techniques. Set fence posts in concrete footings. Fences are to be installed as to the design standards illustrated.

Aluminum fencing finish must be maintained in good condition. No materials (i.e. screening, wire mesh) shall be attached to fences. No barriers or materials shall be placed under, or attached to the bottom of, fences to avoid interference with drainage. Fencing options for small dogs shall be considered during submittal of fencing plan.

A survey locating newly installed fences, unless the new fence joins and aligns with existing approved fences on neighboring lots, is required. The placement of gates is at the discretion of the owner.

Setbacks. A minimum fence setback of five feet (5') from the front corner of the house is required. No front yard fencing is allowed. Fence offsets from the bulkhead cap where fence runs adjacent to the bulkhead cap may be allowed, but must be approved by the DRC.

Fences on adjacent lots to homes owned by the same owner, whether re-platted or not, must be placed an additional five feet (5') from the street setback line and may not encroach on the utility easement. All fences on all lots must be submitted for DRC approval.

Fences on Slopes. The preferred approach to transition grade changes with fencing is to stair-step the fence down the slope, with each bent being level. Each step should be a minimum of three inches (3") and a maximum of six inches (6") (see sketch).

This section does not limit the use of any of the approved handrail systems described in Section 4.9 around ground floor patios within the allowable building area.

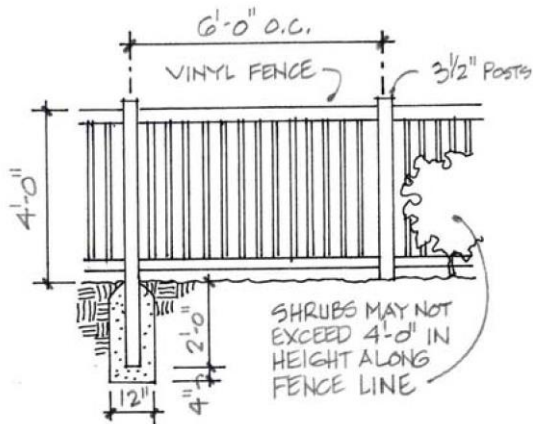

TYPICAL FENCE
DETAIL

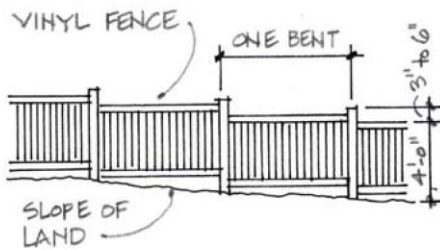

TYPICAL FENCE @ SLOPE

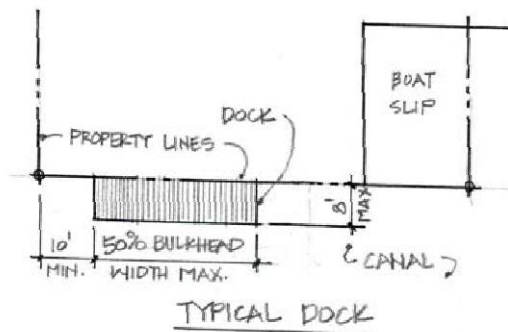
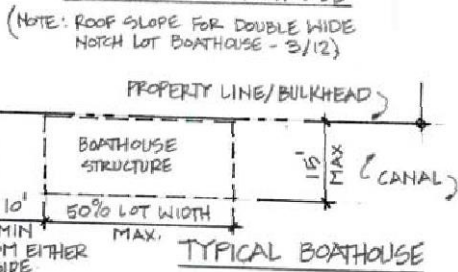
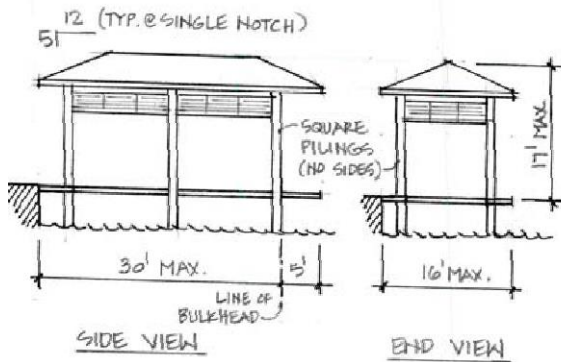
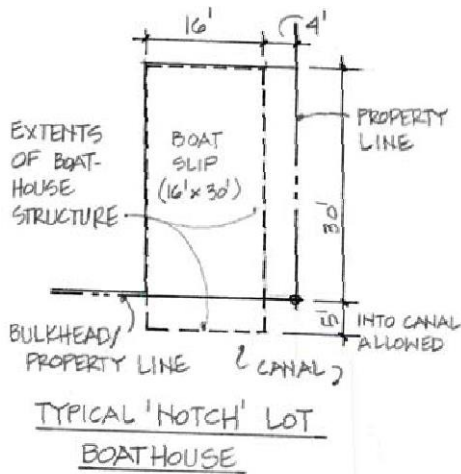

In order to preserve adequate view windows and channel clearances, strict limitations are placed on the location and size of boathouses, docks, and piers at single family lots. All boathouses are to be built to a common design standard to minimize the focus on boathouses and place the focus on the design of the main residence. All dimensions for boathouse requirements are to the outside edge of the plate line and/or dock or piling limit. The boathouse eaves will be allowed to overhang an additional two feet (2') past the plate line.

In order to provide protection from the elements, boathouses are required to have louver panels that extend from the bottom of the support beams to a point twenty-eight inches below the support beam. Louvers shall be on both sides and the end opposite where the boat enters the boathouse. Construction is to be of treated wood and painted to match the rest of the boathouse. Frames are to be 1" x 4" with six (6) slats equally spaced. They are to be set at 30 degrees (see sketch on page 16).

When a boathouse or pier is constructed prior to the immediate construction of a home, construction on the residence must commence within twenty-four (24) months, and the owner must provide temporary off-street parking for two vehicles (18' wide x 20' deep minimum) with a grass-paver type product. No other landscaping is required at this time.

Boathouses: At notch lots, boathouses can only be placed within the notch provided for this purpose. Lots with shared notches generally have a forty-foot wide notch with twenty foot of width each lot. Boathouses at these lots must stop a minimum of four feet (4') from the common property line where it extends through the notch. For those lots with individual notches, the boathouse may span the entire notch. Boathouses at notch lots must extend at least to the rear bulkhead line and may extend a maximum of five feet (5') past the bulkhead line into the canal. The piling should not extend more than three feet (3') into the canal, with the roof overhang being allowed to extend an additional two feet (2'). The roof may overhang the allowable boathouse area up to two feet (2') on the remaining three sides.

For lots without a notch, boathouses may be placed along the back of the lot, parallel to the bulkhead line, and may extend a maximum of fifteen feet (15') into the canal. Boathouses in canals must not extend along the back of the lot more than fifty percent (50%) of the total width of the lot, and must stay at least ten feet from side lot lines. The recorded plat indicates areas where the boathouses may be built, and any change in these locations must be approved in writing by the DRC as part of the plan approval process. If there is a discrepancy between the locations noted on the plat shall prevail. Owners are encouraged to "offset" their boathouses from the center of the lot to allow easier boat access for the owner and the neighboring boathouse once all lots have a boathouse.

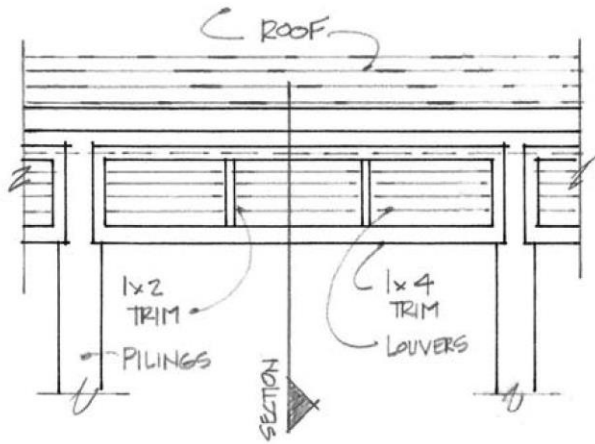

BOATHOUSE LOUVER
ELEVATION

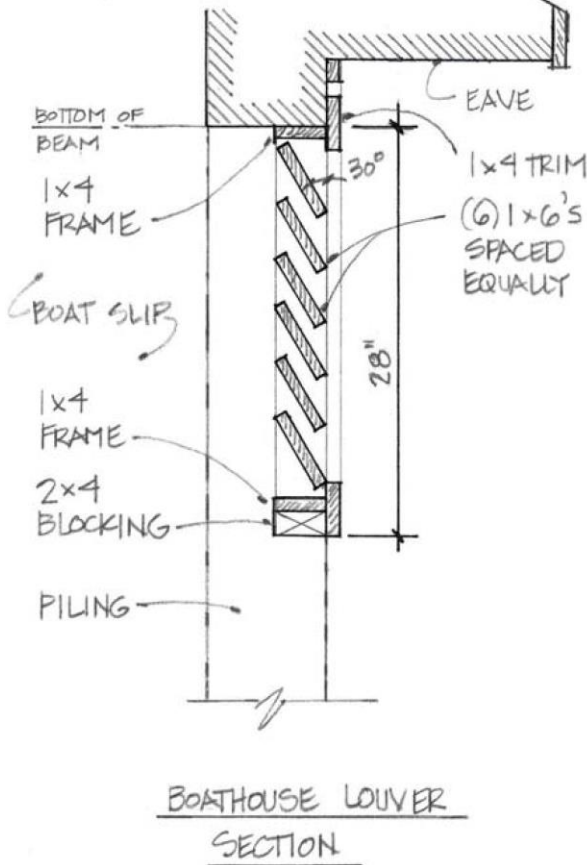

BOATHOUSE LOUVER
SECTION

Touchless Boat Covers: Touchless boat covers are permitted upon approval. Touchless boat covers must complement or match the boathouse and residential structures.

All boathouses shall have a 5 on 12 hip roof, with roof material and trim colors to match the corresponding residence. The maximum height allowable for any part of a boathouse structure is seventeen feet (17') above the bulkhead cap. No decks are allowed above boathouse structures. Select lots have thirty foot notches serving only one lot to allow for storage of two boats. Boathouses at these lots may utilize a 3 on 12 hip roof to allow a wider roof area for coverage of two boats.

Boathouses may not have any walls or screening, and no closets or storage lockers may be built as part of the structure in order to maintain more open views, except for the special "offsite" boathouse design for certain lots described in Section 3.9.

Jet Ski Ramps: Ramps for personal watercraft or other small craft may be included as part of a boathouse structure or dock/piers within the allowable areas.

Docks and Piers: In addition to the boathouse at notch lots, a pier may be built along the back bulkhead line to allow access to the canal for recreational purposes. This pier may extend into the canal a maximum of eight feet, and may have a maximum width of fifty percent (50%) of the lot width at the rear bulkhead line (this lot width is calculated without taking the notch width into consideration). No docks or piers may be built within ten feet (10') of the side property lines.

At standard canal lots, a dock may be incorporated into the boathouse structure and may extend a maximum of fifteen feet (15') into the canal. These docks must fall within the allowable area for the boathouse at each lot, and the boathouse and dock combined may not exceed fifty percent (50%) of the rear lot width. All docks must be self-supporting and may not attach to the bulkhead.

Mooring Areas: Owners who want to store their vessel in a "wet slip" may build a pier and moor their watercraft anywhere within the allowable boathouse areas as defined on the plat and within this Section, but the vessel and pier area must not exceed the maximum area allowed for a boathouse (50% of the rear lot width and no more than the maximum distance from the bulkhead as shown on the plat). Piling at mooring areas may not extend above the maximum height limit above the bulkhead.

A launch ramp is available for resident use at the Harborwalk Marina, and no individual launch ramps will be allowed at lots.

A special condition exists at Lots 2-24, Block 4, Section 4 (“Water Key lots”).

The mooring areas at lots 2-24 are designed for head-in parking and are located across the street from the lot. Per the boathouse restrictions on the recorded plat, boathouses at these lots must be either a sixteen foot (16’) wide single slip boathouse or a thirty foot (30’) wide double slip boathouse based on the standard boathouse design on page 17.

If a sixteen foot (16’) wide single boathouse is constructed an uncovered pier or mooring area may be incorporated alongside as long as the entire structure does not exceed thirty feet (30’) in width.

As an option, homeowners will be allowed to build a thirty foot (30’) wide roof structure with storage for only one boat and the remaining area used for under roof deck.

Owners may also elect to have an open mooring area with no roof structure provided the vessel and attendant piling, piers, and other structures fit within the allowable area. All boathouses and/or piling for mooring areas must comply with the maximum height set forth in Section 3.8.

Because the boathouse location for lots 2-24 is across the street from the lot the standard boathouse design has been modified to include a storage closet. This storage closet should be eight feet (8’) wide and three feet (3’) deep, and should extend from the pier to the boathouse ceiling. The closet should be closely centered in the boathouse. This closet should be finished with Hardie or equal lap siding and painted to match the boathouse. Either a single door or a pair of doors, not to exceed a total six foot (6’) opening, can be used to access the closet and must be located on the side of the closet facing into the boathouse.

A driveway/parking area may be constructed in front of these boathouses that is a maximum of twelve feet (12’) wide and stops at least five feet (5’) from the bulkhead. This parking area shall match the driveway material for the main residence. A walkway with a maximum width of six feet (6’) may extend from the driveway to the boathouse structure. Driveways and walks should be located within the sidelines of the boathouse structure and locations must be differentiated with a curb or grade change. No additional parking is allowed.

Water and power service for these boathouses should be provided by boring under Water Key and extending service lines from the main residence/meter. See Section 5.5 landscaping at Water Key Boathouse Easements for additional information.

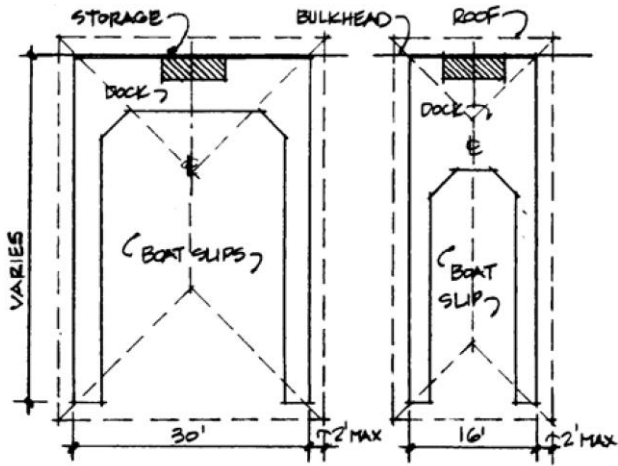

TYPICAL BOATHOUSE PLANS
"WATER KEY LOTS"

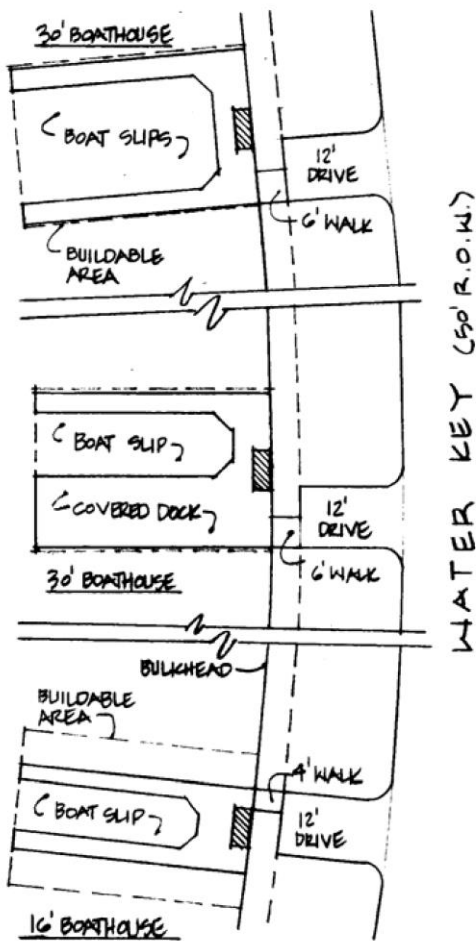

Because Lots 1-24, Block 4, Section 4 are adjacent to a reserve fronting the natural Bayfront the POA will grant an easement for a boardwalk to extend across Reserve 'P' of Section 4 to the adjacent tidally influenced lands of the State of Texas.

As part of the easement agreement with the POA, lot owners must agree to submit plans for all improvements over Reserve 'P' and over the adjacent tidally influenced lands of the State for DRC approval, and to abide by DRC guidelines regarding pier/boardwalk construction over Reserve 'P' and over the adjacent tidally influenced lands.

The boardwalk/piers at this area may be a maximum of eight feet (8') wide and must not extend higher than the adjacent retaining wall/bulkhead elevation (other than handrails). Where piers cross any wetland areas they may be placed at higher elevations than the bulkhead as required by the COE permit, but must return to a level no higher than the bulkhead as soon as allowed under the COE permit.

These piers may extend a maximum of two hundred fifty feet (250') past the POA property line at Reserve 'P'. Handrails may be a maximum of forty-two inches (42") high. No other vertical construction or shade structures may be built on these piers/boardwalks.

Piers at Lots 1, 2 & 24 must be placed perpendicular to the rear lot line. Piers at Lots 3-23 must be placed perpendicular to the front lot line. All piers must be located at least twenty feet (20') from side lot lines, and piers may not extend within one hundred feet (100') of either access channel serving Harborwalk. A T-head will be allowed on the end of the pier with a maximum size of twenty feet (20') by eight feet (8') and must be centered on the pier.

Underwater fishing lights may be placed along these piers. If additional lighting is required for night-time use it must be mounted no higher than the handrail, utilize a maximum bulb size of 75 watts, and be shielded to direct the light downward.

As part of the POA easement agreement at Reserve 'P' lot owners must agree to not dredge or otherwise disturb Reserve 'P' or any adjacent tidally influenced lands of the State.

The lot owner is responsible for all permits and leases that may be required for pier construction including the City of Hitchcock, Army Corps of Engineers, and the General Land Office.

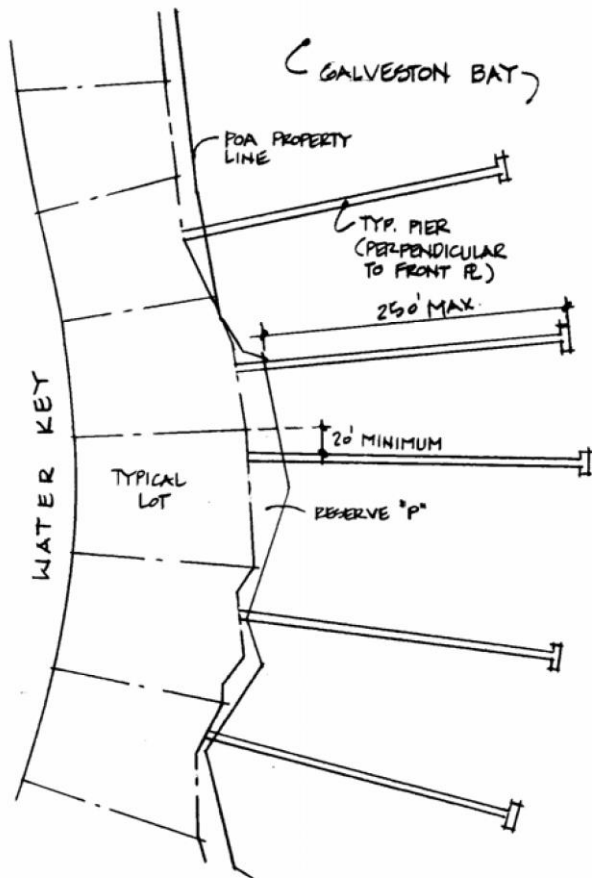

TYPICAL BOARDWALK/PIER
" WATER KEY LOTS "

The mooring areas at Lots 14-23, Block 5, Section 4 are designed for head-in parking.

Per the boathouse restriction on the recorded plat, boathouses at these lots must be either a sixteen foot (16') wide single slip boathouse or a thirty foot (30') wide double slip boathouse based on the standard boathouse design on in Section 3.8.

If a 16' wide single boathouse is constructed an uncovered pier or mooring area may be incorporated alongside as long as the entire structure does not exceed thirty feet (30') in width.

As an option, homeowners will be allowed to build a thirty foot (30') wide structure with storage for only one boat and the remaining area used for under roof deck.

Owners may also elect to have an open Mooring area with no roof structure provided the vessel and attendant piling, piers, and other structures fit within the allowable area.

All boathouses and/or piling for mooring areas must comply with the maximum height set forth in Section 3.8.

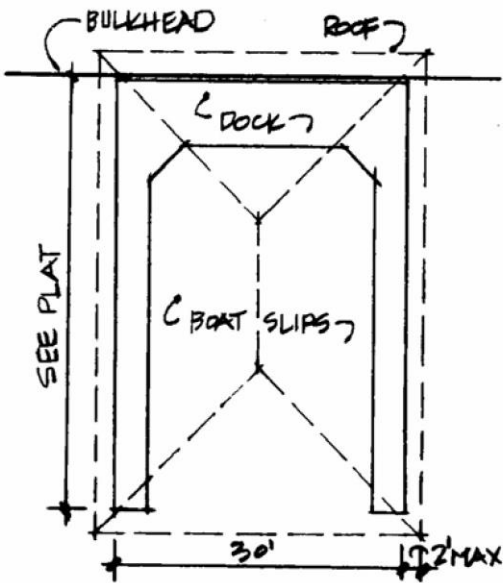

TYPICAL 30' BOATHOUSE PLAN
"SUGARLOAF LOTS"

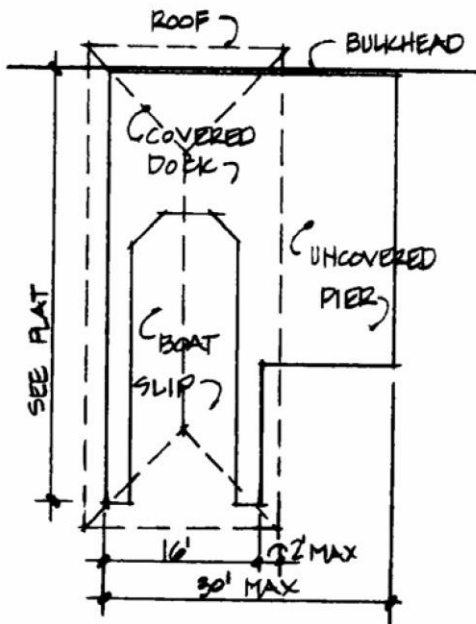

TYPICAL 16' BOATHOUSE PLAN
W/ ATTACHED PIER
"SUGARLOAF LOTS"

Fish cleaning tables incorporated into the house structure and contained within the building setback areas have wide design latitude, but all plumbing must be screened from public view.

If homeowners desire a fish cleaning table at the mooring/boathouse area, it must meet certain criteria to prevent disparity.

All fish cleaning tables located outside the building setbacks areas must be attached to a boathouse or pier. No tables may be attached to the bulkhead since it is owned and maintained by the Municipal Utility District.

Fish cleaning tables at piers and boathouses may use a pre-fabricated table or a job-built table, but all must be screened on three sides with louvered panels. The louver design shall match the boathouse louver design detailed on page 17.

Table surfaces may be a maximum of six feet (6') wide and have a maximum height of forty-two inches (42") above the pier. The louver panels may extend to a maximum height of forty-eight inches (48") above the pier, and must extend at least six inches (6") above the table surface.

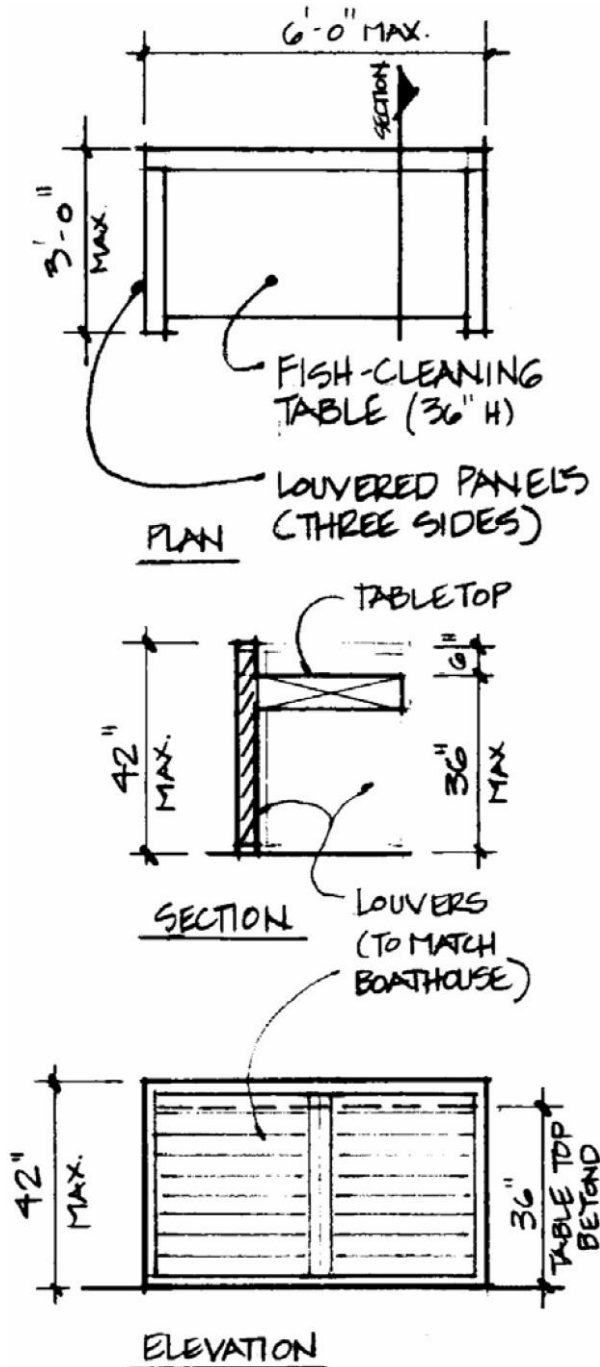

The bulkhead and canal system is maintained by the Flamingo Isles Municipal Utility District (MUD).

If an owner/builder damages the system during construction of a pier or boathouse they should contact the MUD Engineer for information on repairs. All bulkhead repairs or replacement must match the existing bulkhead system and be approved by the MUD Engineer.

Piers and boathouses may not be attached to the bulkhead system, and must instead be supported by a row of freestanding piling along the bulkhead. No additional loading may be placed on the bulkhead by the pier or boathouse.

If an owner desires they may remove only the cap boards of the bulkhead system and replace them with the same material as their pier, provided the pier material is a composite material or one of the rot-resistant Brazilian hardwoods. The bulkhead cap may not be replaced with treated pine material.

The following guidelines are not intended to limit creativity of the builders in their design or construction.

The intent of this section is to establish basic design criteria for the construction of residences and other structures within Harborwalk. Emphasis is on quality materials, design and construction in order to promote well-crafted residences within the community. The house footprint and the roof form should work together to provide variety and interest when viewed from the street and across the canals. These guidelines allow for diversity in design and should produce a climate of individuality, while ensuring the architectural integrity of the community as a whole.

Harborwalk's residential areas are designed to promote "street scenes" that are aesthetically pleasing in character and reflect the feeling of a neighborhood. Developing a "street scene" requires builders to coordinate their architectural designs, as well as landscaping styles, in a manner that maintains a certain level of continuity throughout the community. The purpose of this section is to identify those elements that will influence the overall community appearance and street character.

Builders and designers should take care to vary house plans from those on neighboring lots. Elevations must be distinctly different – material changes or minor changes to architectural elements do not constitute different elevations. Exterior finish colors should vary from those on neighboring homes, including homes across the street or canal.

In Harborwalk Sections 6 and 7, like elevations may occur no more than every fourth house, either across or same side of the street, and no more than five (5) times total on any given street, without DRC approval.

The DRC reserves the right to reject any plan, including one that closely resembles that of a nearby home or in any way detracts from the overall street scene.

The builder/owner shall be responsible for individual site development and maintenance including the area within the street right-of-way (between the edge of paving and property lines). The builder/owners of corner lots shall be responsible for the right-of-way for both streets.

Where there is a POA reserve between the lot and the ROW this reserve will be maintained by the POA.

Exterior finish materials should be used with restraint in regard to both color and diversity of material types. The number of primary materials on the exterior will be limited to three (3), not including roof material and trim, and must be approved by the DRC.

No exposed Concrete Masonry Unit (CMU) will be permitted. If CMU is used in a structural application, it must be covered with one of the approved exterior siding materials.

Samples of all finish materials, and the manufacturer's name and product line must be available to the DRC for approval. Colors must be selected from the approved list. Bold, primary or unusual colors are prohibited. Each builder is required to submit a color palette to the DRC for approval. The following materials are acceptable:

EXTERIOR SIDING

BRICK – Earth tone colors. Bricks shall meet standard specifications established by The Brick Institute of America.

STONE – Natural or synthetic stone in earth tones.

MORTAR JOINTS – All mortar joints shall be tooled; “Slump” joints will not be allowed. Mortar color shall be selected to compliment stone or brick color.

FIBER CEMENT BOARD LAP OR SHINGLE SIDING – Use HardiePlank, HardieShingle or equal.

STUCCO – The use of portland-cement plaster/stucco is permitted. Synthetic stucco-like products are strictly prohibited.

Any additional exterior material must have DRC approval.

No material change should ever occur on an outside corner. The technique of “shirt fronting” of masonry veneer will not be permitted. Material changes are most successful when made as part of a larger offset; for example, a masonry pier or recessed window. Materials must return at least four feet (4') from outside corners.

Gable ends of a uniform material tend to be more architectural than those which change at the eave line. High contrast trim or material variations should be avoided in favor of those which are chosen to blend all elements into a single idea.

ROOF MATERIALS

Materials should be used with restraint in regard to both color and compatibility with other exterior finishes. The intent is to create a continuity of materials throughout the community. The colors are limited to the color palette on the following pages. The following materials are acceptable:

COMPOSITION SHINGLES – Roofing material is required to be a minimum 30-year warranty, such as Elk Prestique II, GS Firehalt or equal.

METAL – Roofs may use concealed or exposed fastener system.

TILES – Roof tiles manufactured from clay or concrete may be used.

SLATE – Natural slate roof tiles will be allowed in any available color. Synthetic slate products will be allowed within the color palette.

THE FOLLOWING MATERIALS ARE SPECIFICALLY PROHIBITED:

- Wood siding
- Plywood siding
- Hardboard or Masonite siding
- Aluminum siding
- Vinyl siding
- Synthetic stucco products and/or EFIS
- Ceramic tile

All colors referenced are Sherwin-Williams part numbers

SW#	COLOR	SW#	COLOR	SW#	COLOR
6000	Snowfall	6075	Garret Gray	6141	Softer Tan
6001	Grayish	6077	Everyday White	6142	Macadamia
6002	Essential Gray	6078	Realist Beige	6143	Basket Beige
6003	Proper Gray	6079	Diverse Beige	6144	Dapper Tan
6004	Mink	6080	Utterly Beige	6145	Thatch Brown
6005	Folkstone	6081	Down Home	6147	Panda White
6007	Smart White	6082	Cobble Brown	6148	Wool Skein
6008	Individual White	6084	Modest White	6149	Relaxed Khaki
6009	Imagine	6085	Simplify Beige	6150	Universal Khaki
6010	Flexible Gray	6086	Sand Dune	6151	Quiver Tan
6011	Chinchilla	6087	Trusty Tan	6152	Superior Bronze
6014	Quartz White	6088	Nuthatch	6154	Nacre
6015	Vaguely Mauve	6091	Reliable White	6155	Rice Grain
6016	Chaise Mauve	6092	Lightweight Beige	6156	Ramie
6021	Dreamy White	6093	Familiar Beige	6157	Favorite Tan
6022	Breathless	6094	Sensational Sand	6158	Sawdust
6023	Insightful Rose	6095	Toasty	6159	High Tea
6028	Cultured Pearl	6098	Pacer White	6161	Nonchalant White
6029	White Truffle	6099	Sand Dollar	6162	Ancient Marble
6030	Artistic Taupe	6100	Practical Beige	6163	Grassland
6031	Glamour	6101	Sands of Time	6164	Svelte Sage
6035	Gauzy White	6102	Portabello	6165	Connected Gray
6036	Angora	6105	Divine White	6168	Moderne White
6037	Temperate Taupe	6106	Kilim Beige	6169	Sedate Gray
6038	Truly Taupe	6107	Nomadic Desert	6170	Techno Gray
6039	Poised Taupe	6108	Latte	6171	Chatroom
6042	Hush White	6109	Hopsack	6172	Hardware
6043	Unfussy Beige	6110	Steady Brown	6175	Sagey
6044	Doeskin	6112	Biscuit	6176	Livable Green
6045	Emerging Taupe	6113	Interactive Cream	6177	Softened Green
6046	Swing Brown	6114	Bagel	6178	Clary Sage
6049	Gorgeous White	6115	Totally Tan	6179	Artichoke
6050	Abalone Shell	6116	Tatami Tan	6182	Ethereal White
6051	Sashay Sand	6119	Antique White	6183	Conservative Gray
6052	Sandbank	6120	Believable Buff	6184	Austere Gray
6056	Polite White	6121	Whole Wheat	6185	Escape Gray
6057	Malted Milk	6122	Camelback	6186	Dried Thyme
6058	Likeable Sand	6123	Baguette	6187	Rosemary
6059	Interface Tan	6126	Navajo White	6189	Opaline
6060	Moroccan Brown	6127	Ivoire	6190	Filmy Green
6063	Nice White	6128	Blonde	6191	Contented
6064	Reticence	6129	Restrained Gold	6192	Coastal Plain
6065	Bona Fide Beige	6130	Mannered Gold	6193	Privilege Green
6066	Sand Trap	6133	Muslin	6194	Basil
6067	Mocha	6134	Netsuke	6195	Rock Garden
6070	Heron Plume	6135	Ecru	6196	Frosty White
6071	Popular Gray	6136	Harmonic Tan	6197	Aloof Gray
6072	Versatile Gray	6137	Burlap	6198	Sensible Hue
6073	Perfect Greige	6138	Artifact	6199	Rare Gray
6074	Spalding Gray	6140	Moderate White	6200	Link Gray

All colors referenced are Sherwin-Williams part numbers

SW#	COLOR
6201	Thunderous
6202	Cast Iron
6203	Spare White
6204	Sea Salt
6205	Comfort Gray
6206	Oyster Bay
6207	Retreat
6208	Pewter Green
6210	Window Pane
6211	Rainwashed
6212	Quietude
6213	Halcyon Green
6214	Underseas
6215	Rocky River
6217	Topsail
6218	Tradewind
6219	Rain
6220	Interesting Aqua
6221	Moody Blue
6222	Riverway
6223	Still Water
6224	Mountain Air
6225	Sleepy Blue
6226	Languid Blue
6227	Meditative
6228	Refuge
6229	Tempe Star
6230	Rainstorm
6231	Rock Candy
6232	Misty
6233	Samovar Silver
6234	Uncertain Gray
6235	Foggy Day
6236	Grays Harbor
6238	Icicle
6239	Upward
6240	Windy Blue
6241	Aleutian
6242	Bracing Blue
6243	Distance
6244	Naval
6245	Quicksilver
6246	North Star
6247	Krypton
6248	Jubilee
6249	Storm Cloud
6250	Granite Peak
6251	Outerspace
6252	Ice Cube
6253	Olympus White
6254	Lazy Gray

SW#	COLOR
6255	Morning Fog
6256	Serious Gray
6257	Gibraltar
6259	Spatial White
6260	Unique Gray
6261	Swanky Gray
6262	Mysterious Mauve
6266	Discreet White
6267	Sensitive Tint
6268	Veiled Violet
6269	Beguiling Mauve
6273	Nouvelle White
6274	Destiny
6275	Fashionable Gray
6276	Mystic Shade
6277	Special Gray
6278	Cloak Gray
6385	Dover White
6427	Sprout
6428	Honeydew
6429	Baize Green
6430	Great Green
6431	Leapfrog
6434	Spinach White
6435	Gratifying Green
6436	Bonsai Tint
6437	Haven
6438	Dill
6439	Greenfield
6440	Courtyard
6441	White Mint
6442	Supreme Green
6443	Relish
6444	Lounge Green
6445	Garden Grove
6446	Arugula
6447	Evergreens
6448	Greening
6449	Topiary Tint
6450	Easy Green
6451	Nurture Green
6452	Inland
6453	Cilantro
6454	Shamrock
6455	Fleeting Green
6456	Slow Green
6457	Kind Green
6458	Restful
6459	Jadite
6460	Kale Green
6461	Isle of Pines

SW#	COLOR
6462	Green Trance
6463	Breaktime
6464	Aloe
6465	Spearmint
6466	Grandview
6467	Kendal Green
6468	Hunt Club
6469	Dewy
6470	Waterscape
6471	Hazel
6472	Composed
6473	Surf Green
6474	Raging Sea
6475	Country Squire
6476	Glimmer
6477	Tidewater
6478	Watery
6479	Drizzle
6480	Lagoon
6481	Green Bay
6482	Cape Verde
6483	Buoyant Blue
6484	Meander Blue
6485	Raindrop
6486	Reflecting Pool
6487	Cloudburst
6488	Grand Canal
6489	Really Teal
6490	Timid Blue
6491	Open Air
6192	Jetstream
6493	Ebbtide
6494	Lakeshore
6495	Great Falls
6496	Oceanside
6497	Blue Horizon
6498	Byte Blue
6499	Stream
6500	Open Seas
6501	Manitou Blue
6502	Loch Blue
6503	Bosporus
6504	Sky High
6505	Atmosphere
6506	Vast Sky
6507	Resolute Blue
6508	Secure Blue
6509	Georgian Bay
6510	Loyal Blue
6511	Snowdrop
6512	Balmy

All colors referenced are Sherwin-Williams part numbers

SW#	COLOR
6513	Take Five
6514	Respite
6515	Leisure Blue
6516	Down Pour
6517	Regatta
6518	Ski Slope
6519	Hinting Blue
6520	Honest Blue
6521	Notable Hue
6522	Sporty Blue
6523	Denim
6524	Commodore
6525	Rarified Air
6526	Icelandic
6527	Blissful Blue
6528	Cosmos
6529	Scanda
6530	Revel Blue
6531	Indigo
6672	Morning Sun
6673	Banana Cream
6674	Jonquil
6675	Afternoon
6676	Butterfield
6677	Goldenrod
6679	Full Moon
6680	Friendly Yellow
6681	Butter Up
6682	June Day
6686	Lemon Chiffon
6687	Lantern Light
6688	Solaria
6689	Overjoy
6693	Lily
6694	Glad Yellow
6695	Midday
6696	Quilt Gold
6700	Daybreak
6701	Moonraker
6702	Lively Yellow
6703	Frolic
6707	Narcissus
6708	Springtime
6709	Gleeful
6710	Melange Green
6711	Parakeet
6714	Citrine
6715	Lime Granita
6716	Dancing Green
6717	Lime Rickey
6718	Overt Green

SW#	COLOR
6719	Gecko
6720	Paradise
6721	Enlightened Lime
6722	Cucumber
6723	Jardin
6724	Mesclun Green
6725	Pickle
6726	Talipot Palm
6727	Houseplant
6728	White Willow
6729	Lacewing
6730	Romaine
6731	Picnic
6732	Organic Green
6733	Grasshopper
6734	Espalier
6735	Minted
6736	Jocular Green
6737	Kiwi
6738	Vegan
6739	Eco Green
6740	Kilkenny
6741	Derbyshire
6742	Lighter Mint
6743	Mint Condition
6744	Reclining Green
6745	Lark Green
6746	Julep
6747	Argyle
6748	Greens
6749	Embellished Blue
6750	Waterfall
6751	Refresh
6752	Larchmere
6753	Jargon Jade
6754	Ionian
6755	Starboard
6756	Crystal Clear
6757	Tame Teal
6758	Aqueduct
6759	Cooled Blue
6760	Rivulet
6761	Thermal Spring
6762	Poseidon
6763	Retiring Blue
6764	Swimming
6765	Spa
6766	Mariner
6767	Aquarium
6768	Gulfstream
6769	Maxi Teal

SW#	COLOR
6770	Bubble
6771	Bathe Blue
6772	Cay
6773	Rapture Blue
6774	Freshwater
6775	Briny
6776	Blue Nile
6777	Carefree
6778	Aviary Blue
6779	Liquid Blue
6780	Nautilus
6781	Jamaica Bay
6782	Cruising
6783	Amalfi
6784	Bravo Blue
6785	Quench Blue
6786	Cloudless
6787	Fountain
6788	Capri
6789	Blue Mosque
6791	Adriatic Sea
6791	Lauren's Surprise
6792	Minor Blue
6793	Bluebell
6794	Flyway
6795	Major Blue
6796	Blue Plate
6797	Jay Blue
6798	Iceberg
6799	Soar
6800	Something Blue
6801	Regale
6802	Jacaranda
6803	Danube
6804	Dignity Blue
6900	Optimistic Yellow
6901	Daffodil
6902	Decisive Yellow
6903	Cheerful
6904	Guston Gold
6905	Goldfinch
6906	Citrus
6907	Forsythia
6908	Fun Yellow
6909	Lemon Twist
6910	Daisy
7000	Ibis White
7001	Marshmallow
7002	Downy
7003	Toque White
7004	Snowbound

All colors referenced are Sherwin-Williams part numbers

SW#	COLOR
7005	Pure White
7006	Extra White
7007	Ceiling Bright White
7008	Alabaster
7009	Pearly White
7010	White Duck
7011	Natural Choice
7012	Creamy
7013	Ivory Lace
7014	Eider White
7015	Repose Gray
7016	Mindful Gray
7017	Dorian Gray
7018	Dovetail
7019	Gauntlet Gray
7021	Simple White
7022	Alpaca
7023	Requisite Gray
7024	Functional Gray
7025	Backdrop
7028	Incredible White
7029	Agreeable Gray

SW#	COLOR
7030	Anew Gray
7031	Mega Greige
7032	Warm Stone
7035	Aesthetic White
7036	Accessible Beige
7037	Balanced Beige
7038	Tony Taupe
7039	Virtual Taupe
7040	Smokehouse
7042	Shoji White
7043	Worldly Gray
7044	Amazing Gray
7045	Intellectual Gray
7046	Anonymous
7049	Nuance
7050	Useful Gray
7051	Analytical Gray
7052	Gray Area
7053	Adaptive Shade
7056	Reserved White
7057	Silver Strand

SW#	COLOR
7058	Magnetic Gray
7059	Unusual Gray
7060	Attitude Gray
7061	Night Owl
7063	Nebulous White
7064	Passive
7065	Argos
7066	Gray Matters
7067	Cityscape
7068	Grizzle Gray
7070	Site White
7071	Gray Screen
7072	Online
7073	Network Gray
7074	Software
7075	Web Gray
7077	Original White
7078	Minute Mauve
7079	Ponder
7080	Quest Gray
7081	Sensuous Gray

All colors referenced are Sherwin-Williams part numbers

SW#	COLOR
6006	Black Bean
6012	Browse Brown
6013	Bitter Chocolate
6017	Intuitive
6018	Enigma
6019	Poetry Plum
6020	Marooned
6024	Dressy Rose
6025	Socialite
6026	River Rouge
6027	Cordovan
6032	Dutch Cocoa
6033	Bateau Brown
6034	Arresting Auburn
6040	Less Brown
6041	Otter
6047	Hot Cocoa
6048	Terra Brun
6053	Reddened Earth
6054	Canyon Clay
6055	Fiery Brown
6061	Tanbark
6062	Rugged Brown
6068	Brevity Brown
6069	French Roast
6076	Turkish Coffee
6083	Sable
6089	Grounded
6090	Java
6096	Jute Brown
6097	Sturdy Brown
6103	Tea Chest
6104	Kaffee

SW#	COLOR
6111	Coconut Husk
6117	Smokey Topaz
6118	Leather Bound
6124	Cardboard
6125	Craft Paper
6131	Chamois
6132	Relic Bronze
6139	Mossy Gold
6146	Umber
6153	Protégé Bronze
6160	Best Bronze
6166	Eclipse
6167	Garden Gate
6173	Cocoon
6174	Andiron
6180	Oakmoss
6181	Secret Garden
6188	Shade-Grown
6209	Ripe Olive
6216	Jasper
6237	Dark Night
6258	Tricorn Black
6263	Exclusive Plum
6264	Midnight
6270	Soulmate
6271	Expressive Plum
6272	Plum Brown
6279	Black Swan
6432	Garden Spot
6433	Inverness
6678	Sunflower
6683	Bee
6684	Brittlebush

SW#	COLOR
6685	Trinket
6690	Gambol Gold
6691	Glitzy Gold
6692	Auric
6697	Nugget
6698	Kingdom Gold
6699	Crispy Gold
6704	Hep Green
6712	Luau Green
6713	Verdant
6911	Confident Yellow
6988	Bohemian Black
6989	Domino
6990	Caviar
6991	Black Magic
6992	Inkwell
6993	Black of Night
6994	Greenblack
7020	Black Fox
7026	Griffin
7027	Well-Bred Brown
7033	Brainstorm Bronze
7034	Status Bronze
7041	Van Dyke Brown
7047	Porpoise
7048	Urbane Bronze
7054	Suitable Brown
7055	Enduring Bronze
7062	Rock Bottom
7069	Iron Ore
7076	Cyberspace
7082	Stunning Shade
7083	Darkroom

**APPROVED
SHINGLE COLORS:**

(Colors are Atlas Roofing designations)

- Antique Black
- Atlantic Blue
- Black Shadow
- Coastal Gray
- Dove Gray
- Hearthstone Gray
- Heatherblend
- Heritage Red
- Natchez Gray
- Slate Gray
- Surf Blue
- Weathered Shake
- Weathered Wood
- Woodland Green

**APPROVED
CLAY TILE COLORS:**

(Colors are Guiraud Freres designations)

- Brown
- Cathedral
- Clear Oldish Provence
- Dark Oldish Provence
- Gray
- Manor
- Medieval
- Oldish
- Pink
- Red
- Straw
- Tobacco
- Vieux Midi

**APPROVED
METAL COLORS:**

(Colors are Berridge Manufacturing designations)

- Aged Bronze
- Bristol Blue
- Buckskin
- Burgundy
- Champagne
- Charcoal Gray
- Colonial Red
- Copper Brown
- Copper-Cote
- Dark Bronze
- Deep Red
- Forest Green
- Hartford Green
- Hemlock Green
- Lead-Cote
- Matte Black
- Medium Bronze
- Parchment
- Patina Green
- Pre-weathered Galvalume
- Royal Blue
- Satin Finish Galvalume
- Shasta White
- Sierra Tan
- Teal Green
- Terra-Cotta
- Zinc Gray

**APPROVED
CERAMIC SLATE COLORS:**

(Colors are Celadon Ceramic Slate designations)

- Brunswick Black
- Montpelier Green
- Plumstone
- Slate Gray
- Slate Red

**APPROVED
CONCRETE TILE COLORS:**

(Colors are Vande Hey-Raleigh designations)

- Adobe Red
- Anderson Gray
- Autumn Rust
- Black
- Brick Brown
- Brookville Green
- Burnt Orange
- Carmel Stone
- Charcoal Gray
- Cocoa Brown
- Dark Brown
- Dark Putty
- Dark Red
- Desert Sand
- Driftwood
- Earth Brown
- Forest Green
- French Clay
- French Orange
- Goldenrod
- Gray Sand
- Hazy Gray
- Light Charcoal Gray
- Light Green
- Light Sea Green
- Midnight Black
- Moss Rock
- Pale Red
- Pebble Gray
- Plum
- Putty
- Raleigh Red
- Saddle Brown
- Sandstone
- Sea Green
- Silver Gray
- Sizzler Beige
- Terra Cotta
- White

All of Harborwalk community is located in a V-Zone, and construction must be elevated due to FEMA elevation requirements for the coastal flood plain. Builders are encouraged to familiarize themselves with the Construction Bulletins issued by FEMA regarding Coastal Area Construction in V-Zones.

Piling should be square treated wood or square cast in place concrete columns. For purposes of this section “cast-in-place” means that temporary forms are erected and then removed after the concrete cures. CMU columns may be used, but any CMU columns exposed to public view (all those not contained within an enclosed garage) must be covered with one of the approved exterior materials listed in Section 4.2. No round pilings shall be permitted.

Concrete pilings must be painted or covered with stucco. Wood piling must be painted. Unfinished piling or columns will not be allowed.

Builders and designers should take care in designing piling placement to ensure they do not interfere with the subsurface bulkhead tie-back system. Application must be made 60 days prior to construction with the Flamingo Isles Municipal Utility District (MUD) for the location of the subsurface tie-back system on specific lots.

No exposed angle bracing from pilings to floor stringers will be permitted. Elevated structures may be cross braced against the floor joists to prevent racking of structures, and floor joist stringers must be of adequate size to carry floor joists without angle bracing from the pilings to the stringers. All stringer attach to columns are required to use stainless bolts.

Break-away downstairs walls can be finished with siding to match the upstairs of the house, or can consist of painted wood louver panels or vinyl louver panels.

Lattice panels may also be used to enclose garage bays. If lattice is used each panel must be job-built from wood material instead of using pre-made sheets.

If portions of the foundation are exposed greater than twelve inches (12”) above grade, the outside of these foundation areas must be covered with an approved exterior building material, or landscaping, and may not be left unfinished concrete. Foundation must be completely screened through dense landscaping or staining the concrete.

EQUIPMENT PLATFORMS

Platforms for mechanical and electrical equipment or communications dishes must be cantilevered from the structure – no vertical or diagonal supports or bracing, including decorative brackets, are allowed.

Equipment platforms may cantilever up to four feet (4') over building setback lines to avoid recessing them into alcoves in the wall.

Equipment must be screened from view using a handrail or pony wall structure (see sketch).

If additional area is needed, or exceptionally heavy equipment is to be mounted, builders may mount the equipment on the end of a conventional porch or deck with picket handrails and screen this area from the remainder of the porch or deck using the same handrail.

Wall mounted utilities are to be painted to match wall color.

ELEVATORS & LIFTS

Elevators and lifts are permitted. Boat lifts specifications are addressed in Sections 3.8-3.11. In order to maintain the aesthetic plan of the community, elevators and lifts must meet the following criteria:

- Elevators and lifts, and all their components, must be fully enclosed.
- Elevator and lift enclosures must either be part of, or attached to, the residential structure.
- Elevator and lift enclosures must match the design and color scheme of the structure.

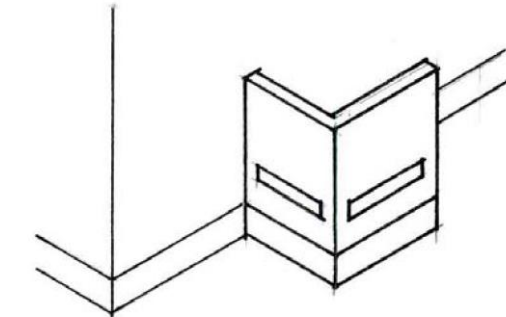
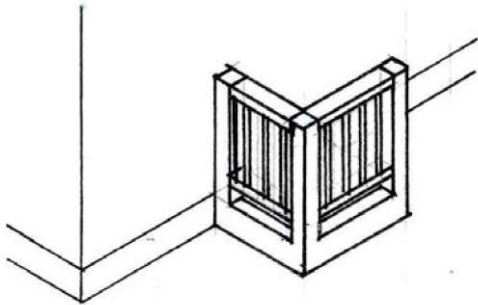
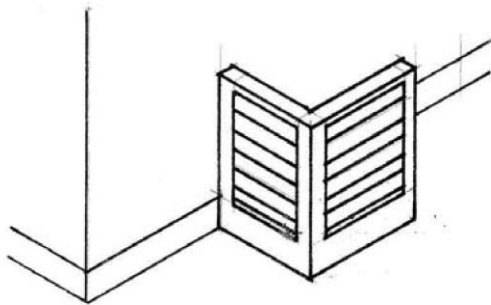
SOLIDRAILINGLOUVERSTYPICAL EQUIPMENT
PLATFORM SCREENS

Care should be given to the size, type and organization of all windows. They should never appear like surface holes cut into the side of the box. They should be architectural features and, wherever possible, grouped into recessed areas or bordered by projections which provide a shadow pattern. Scattered windows tend to create awkward, face-like shapes and should be avoided.

Window frames shall be manufactured from vinyl or aluminum. Aluminum frames shall be bronze, mill, or white finish.

Use of energy efficient windows is encouraged for energy conservation purposes. Textile or similar sunscreens will not be permitted. If a film is applied to the window to reduce transmission of light or heat this film should not appear mirror-like or reflective from the exterior of the house. Window coverings facing a street or a canal must complement the color of the house.

Address signage should be either a plaque or individual cast numbers attached to the house, or a pre-cast address plaque set in stucco finish. Free-standing address plaques will be allowed in yards if constructed of the same materials as above and are securely placed.

Cluster mailboxes are provided by the developer. No other mail, newspaper, or other delivery receptacles are allowed in the front yard or street right-of-way.

Large front-facing gables should be avoided unless they are broken into small scale elements. Otherwise, open gables are better facing toward interior side lot lines.

Changes in roof geometry are best when accompanied by offsets in plan. Avoid flat roofs, a minimum slope on all roofs should be 5 in 12 pitch. Porches and overhangs may utilize a minimum slope of 3 in 12 pitch. A combination of roof pitches may be used if they are integrated in to the design of the house. The roofs, as an expressive design element, should be kept as visually unobstructed as possible.

Decorative roof brackets at the eave are permissible. This is the only place decorative brackets may be used.

If a chimney is used it should be a minimum dimension of thirty inches by thirty-six inches (30" x 36"), and should be constructed of brick, stone, stucco, or fiber-cement siding (Hardie or equal).

The location and design of all skylights and solar collectors shall be approved by the DRC.

All antennae or satellite dishes must be located as inconspicuously as possible from public view.

Rooftop or window HVAC equipment is not permitted under any circumstances.

Solar Energy Device means a system or series of mechanisms designed primarily to provide heating or cooling or to produce electrical or mechanical power by collecting and transferring solar-generated energy, and includes a mechanical or chemical device that has the ability to store solar-generated energy for use in heating or cooling or in the production of power.

The prior written approval of the DRC shall be required for an owner to install any Solar Energy Device. Any application to the DRC for installation of a Solar Energy Device must state the proposed installation location of the Solar Energy Device and include a description of the Solar Energy Device, including the dimensions, manufacturer, and photograph or other accurate depiction, and other information as DRC may request.

The DRC may not withhold approval for installation of a Solar Energy Device UNLESS determined that placement of the Solar Energy Device will create a condition that substantially interferes with the use and enjoyment of the property within the community by causing unreasonable discomfort or annoyance to persons of ordinary sensibilities. Such determination will be negated if all owners of property immediately adjacent to, or in view of proposed placement, provide written approval.

Except as otherwise approved in writing by the DRC, the following Solar Energy Devices are prohibited:

- A Solar Energy Device that, as adjudicated by a court, threatens the public health or safety, or violates a law.
- A Solar Energy Device that is located on property owned or maintained by the Association.
- A Solar Energy Device that is located on property owned in common by the members of the Association.
- A Solar Energy Device that is located in an area on the owner's property other than on the roof of the home or other structure approved by the DRC, or in a fenced yard or patio owned and maintained by the owner or resident.
- A Solar Energy Device, if mounted on the roof of the home, that extends higher than or beyond the roofline, is located in an area other than an area designated by the DRC, unless the alternate location increases the estimated annual energy production by more than ten percent (10%) above the DRC approved location (such determination to be made by using a publicly available modeling tool provided by the National Renewable Energy Laboratory).
- A Solar Energy Device that does not conform to the slope of the roof and has a top edge that is not parallel to the roofline.
- A Solar Energy Device that has a frame, a support bracket, or visible piping or wiring that is not in a silver, bronze, or black tone commonly available in the marketplace.
- A Solar Energy Device, if located in a fenced yard or patio, that is taller than the fence line.
- A Solar Energy Device that, as installed, voids material warranties.

Garage doors should not dominate the façade. When this occurs, the house generally adds little to the overall character of the street and the house entrance is visually overwhelmed. When garage bays are placed side by side, two single doors divided by a column are encouraged. This breaks up the expanse of the door into appropriately scaled architectural elements.

On front-loaded garages a setback of four feet (4') minimum from the front most enclosed wall of the house to the face of the garage is required. This setback can be achieved using a front porch extended over the entrance to the garage bays, or by recessing the garage with a portico in front of the doors. Entrances or stairs that are projected from the front elevation of the house also help take the focus off the garage doors. Carports are prohibited. Porte cochères are permitted with DRC approval.

Notch lots are able to utilize swing-in, or side loaded, garages. This plan minimizes the effect of the garage on the street scene, and allows for more off-street parking in the driveway (see sketch).

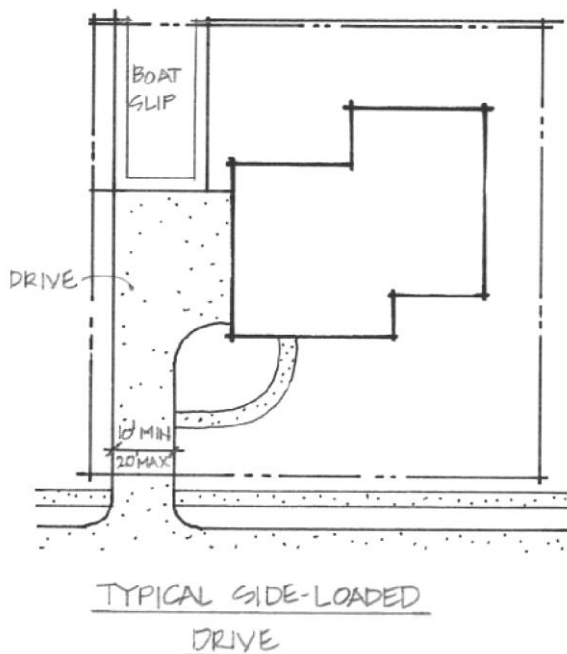

Garages at corner lots will be allowed on the side of the house, with the driveway extending to the side street.

Garages must accommodate the storage of at least two (2) full size automobiles, and must be fully enclosed on all sides using one of the wall systems described in Section 4.3. An extension in the length of a garage which permits additional storage space is allowed. Harborwalk Section 7 must accommodate the storage of one (1) full sized automobile and must be fully enclosed as described above.

If a rear garage door is used it must have at least a four foot (4') portico created by a porch/room above.

All garage doors should be of a color which complements the adjacent wall. No wood or particle board doors are permitted. All garage doors are to be paneled metal or fiberglass. Glass fenestration is permitted. No reflective film or foil is permitted on windows.

In order to prevent great disparity between neighboring houses, each lot will have minimum and maximum sizes allowable for a home on that lot.

These square footage requirements apply only to air-conditioned areas of the home – attics, garages, porches, and other similar areas are not to be included in the calculation of the square footage.

The minimum and maximum allowable areas for each lot designation are as shown in the chart below.

Lot Designation	Minimum Sq. Footage	Maximum Sq. Footage
EL 1	2,800	N/A
EL 2	3,500	N/A
RL 1	2,200	N/A
RL 2	2,500	N/A
SL 1	1,250	1,850
SL 2	1,800	2,300
SL 3	2,100	2,600

No house, building or structure shall be more than three (3) stories of living area in height (not including the garage level). No part of any house, excluding chimney stacks, will be allowed more than fifty feet (50') above the center of street elevation in front of the house. Open decking will be permitted above the third level provided the handrails and other parts of the structure do not extend above the maximum allowable height.

The elevation of the foundation should be no more than six inches (6") below or eighteen inches (18") above the elevation of the edge of the street in front of the lot. Refer to Section 4.3 Elevate Construction for additional information.

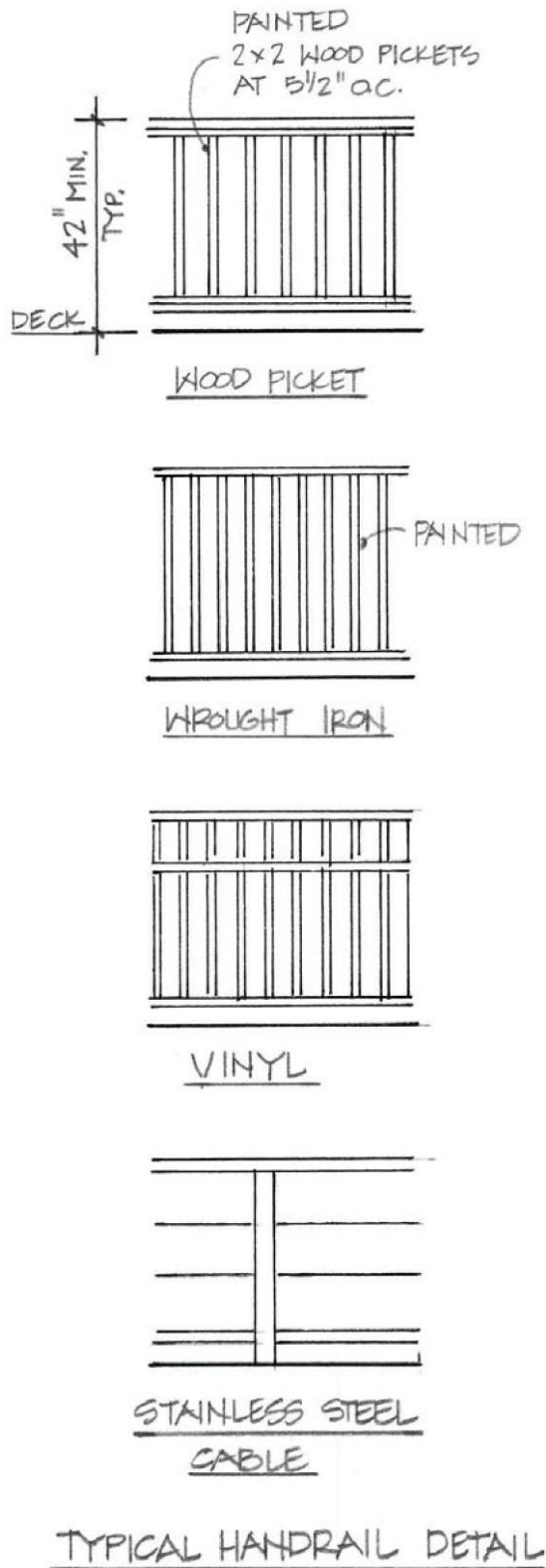

Porches provide comfortable gathering and entertaining spaces, and add character and life to a house design. Porches are required at the front and rear of all houses.

A minimum porch area equal to fifteen percent (15%) of the air-conditioned space must be provided at each single family residence. Porch area equal to at least five percent (5%) of the air-conditioned space must be provided at the front of the house, either at the entry, or as separate balcony(s), and a minimum porch area equal to at least five percent (5%) of the air-conditioned space must be provided at the rear of the house.

For purposes of calculating the minimum porch area requirements only deck areas under roof lines will be counted. Open decks will not qualify as porch area. Entry alcoves at downstairs entries that are directly adjacent to the stairs will also count toward this requirement. Garage porticos, dockside living areas, or other ground floor areas will not count toward the porch requirement.

If builders/designers prefer to use an “arbor” type roof structure over porch areas this may be done at living level floors (not at the garage level). Arbor type porch structures may only be used to satisfy up to one-third of the total required porch area.

Handrails at porches should be constructed from 2x2 pickets, vinyl pickets, wrought iron or steel pickets, or a stainless cable system. Use of lattice in handrails is prohibited. Use of horizontal or vertical PVC pipe is prohibited.

All exposed wood in vertical stair construction includes posts, stringers, and railings must be sealed and painted or stained. If specialty or exotic woods are used in which sealing, paint and stain treatment is not recommended that material may be considered with prior DRC approval.

If mesh screening is used at porches the mesh used must be bronze, fiberglass, or Kevlar material.

The builder/owner is responsible for the landscaping of all areas on his/her property and the portion of the street right-of-way between the property line and the street curb. Plantings other than groundcovers and low growing ornamentals between the street curb and the paved sidewalk are discouraged in order to preserve adequate sight lines for motorists.

Installation of all landscaping must occur prior to occupancy of the house. Installation of landscaping, including materials and workmanship, must comply with current industry standards.

The following landscaping standards are applicable to all typical lots. Planting materials for larger and/or oversized lots should be increased proportionally in plant size and quantity per the requirements in these guidelines.

A landscape plan must be included in the DRC submittal process as outlined in Section 6.5.

(Note: This section applies to permanent lighting, and is not intended to discourage, or prohibit in any way, seasonal holiday lighting and decorations.)

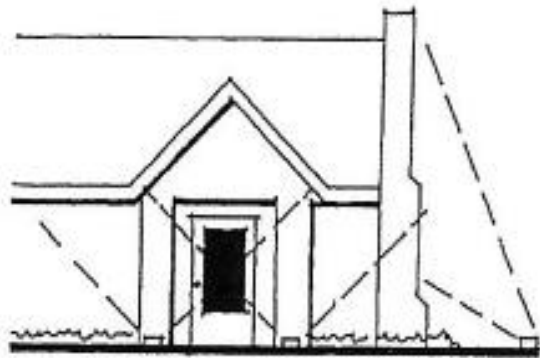

ENCOURAGED

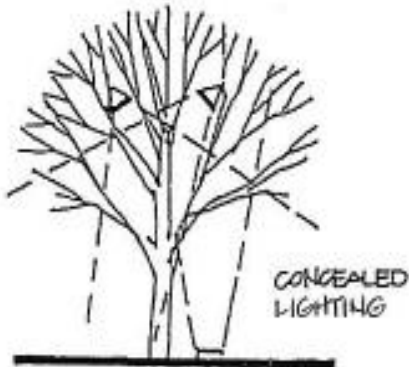
ACCENT LIGHTING
ON ARCHITECTURAL
FEATURES

ENCOURAGED

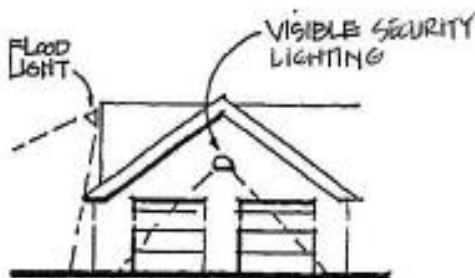
CONCEALED
LIGHTING

NOT PERMITTED

The builder/owner is to install and maintain lighting on individual lots in a manner to not cause distraction, nuisance or to be unsightly. Light sources should not conflict with the sight lines of pedestrians or motorists in a manner which endangers their safety and welfare. Light sources must not “spill over” into neighboring yards. Light sources must be concealed or shielded.

Exterior residential lighting can convey a warm, inviting atmosphere. Care is to be taken in placing fixtures, selection of fixtures and types of light source. Exterior illumination of architectural features such as columns, entries, chimneys and landscape features is encouraged.

Lights should be directed to illuminate house number graphics. A sconce light is preferred. Ground lighting or decorative fixtures must be of high quality materials and workmanship and be in scale and style with the residence. Flood lighting may only be mounted so that no light is shining on neighboring property.

Free standing decorative fixtures and lampposts are acceptable, but must be approved by the DRC.

Sodium vapor lights, except for subdivision street lights, are prohibited.

Flood lights or security lights, when the fixture is visible from public view or from other lots, are prohibited. Decorative lights, when used for special landscape lighting effect, (hung in trees as up and down lights) are permissible with DRC approval.

Colored lenses on low voltage lights, colored light bulbs, fluorescent and neon lighting are not permissible.

Incandescent, low voltage lights, colored light bulbs, fluorescent and neon lighting are not permissible.

Solar power lights are suggested for dock area.

All wiring for exterior lighting should be underground. Pathway lighting and landscape lighting is encouraged. Such lighting must be inconspicuous.

Lights at docks and piers should not create a disturbance to neighboring residences. All fishing lights intended to attract bait shall be underwater.

A single row of foundation planting in the front yard is not acceptable. Planting shall consist of a combination of shrubs, groundcover and perennials in multiple layers, proportioned to the scale of the house.

Landscaping is required in the front yard, rear yard and any area exposed to the public view. A minimum of six (6) fifteen (15) gallon shrubs are required in all rear yards. No trees are required in the rear yards.

Planting bed edging is not required, but is encouraged for maintenance purposes and to define the shape of planting beds. Loos brick, plastic, concrete scallop and corrugated aluminum, wire wickets, horizontal timbers, railroad ties, etc., are prohibited. Acceptable edging includes stone, concrete, natural stone, brick set in mortar, and landscape timbers (2" x 4", 2" x 6", 4" x 4", and 4" x 6") set vertically in grade. Horizontal landscape timbers may only be used in the event of retaining walls in place of grading.

Planting beds may be curvilinear or geometric with the shrubs massed in tiers, smaller shrubs, perennials, and ground cover in the front and larger shrubs in the rear of the bed. Groupings of shrubs of the same species provide a substantial look. Curvilinear beds should have smooth, flowing curves and/or true radii.

Mulch all planting beds with shredded hardwood mulch. No gravel or rock of any size or color is permitted for use or substitution for shrubs, ground cover, mulch or grass lawns. Specimen boulders 12" in diameter or greater are permitted in Earth tone colors only. Bright colors are not permitted. Multi-level planting beds at the rear of the house will be permitted in the setback areas provided that the top of the bed is no higher than the street elevation directly in front of the house, and that the bed returns to the natural ground elevation at least eight feet (8') from the property line to avoid excessive loading on the bulkhead system due to a raised grade.

All yard areas exposed to public view are to be 'solid', sodded with St. Augustine, common Bermuda, a Bermuda hybrid, or Seashore Paspalum grass. Lawns may be over-seeded with rye grass in the Winter.

A limited quantity of landscape gravel or rock of may be permitted for ground cover, or mulch, but should not be a substitute for grass lawn when visible from public view. Drainage channels lined with gravel will be allowed to prevent erosion of beds due to run-off. No planting other than grass lawn should occur within five feet (5') of any street edge.

UNACCEPTABLE ACCEPTABLE

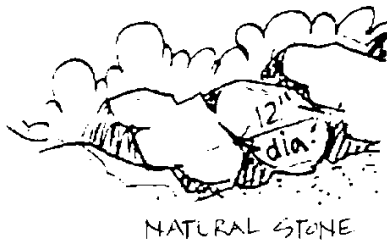
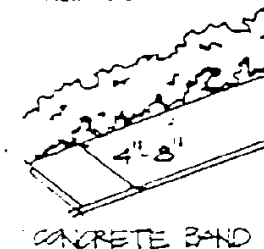
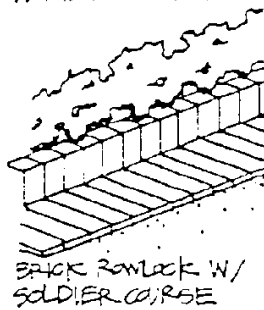
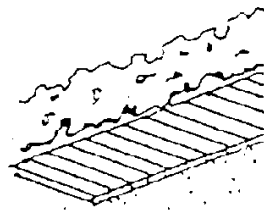
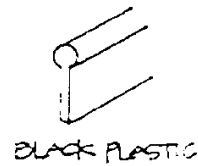

Trees are to be a minimum three inch (3”) caliper measured twelve inches (12”) from the base of the tree.

FRONT YARD TREE REQUIREMENTS		
Lot Width	Trees Required	Type
Up to 90'	2	Hardwoods or Palms
90' +	3	Hardwoods or Palms

FRONT YARD SHRUB REQUIREMENTS		
Lot Width	Shrubs Required	Type
Up to 90'	3	15 gallon
	15	5 gallon
	30	1 gallon
90' +	5	15 gallon
	25	5 gallon
	40	1 gallon

REAR YARD SHRUB REQUIREMENTS		
Lot Width	Shrubs Required	Type
All Lots	6	15 gallon

The requirement for 5 gallon shrubs may be met by double the amount of 3 gallon shrubs. (i.e. 15 – 5 gallon shrubs may be replaced with 30 – 3 gallon shrubs).

Any foundation area exceeding twelve inches (12”) of exposure must be completely screened on all sides of the home with minimum 5 gallon shrubs or the concrete must be stained.

For purposes of this section, the lot width shall be defined as the front lot width, measured at the respective property lines.

Residences shall not have individual planting schemes which differ greatly from neighboring homes. All planting schemes must be complementary in nature with a limited number of dissimilar elements.

All yard decorations and potted plants must be approved by the DRC to ensure uniformity throughout the community and conformity with the Association’s Governing Documents.

Landscaping for Water Key Reserve areas located between boathouse/pier easement bulkheads and street shall have the restrictions listed as follows:

Landscaping, as well as grade level patios and decks are encouraged.

Up to sixty-five percent (65%) of total boathouse easement width, and depth from bulkhead to street may be covered with hardscaping. This would include drive allowed (refer to Section 3.9), walkways, patios, and decks. A minimum of thirty-five percent (35%) of this area must be landscaping and/or green open space.

Any retaining wall or permanent seat/bench structure may not exceed the center of street elevation in height.

Refer to Section 3.3. Walkways and Section 3.9 Boathouses & Docs at Water Key for more information.

Because they are invasive, not in character with the community, or for other reasons, the following plants have been specifically disallowed for use within Harborwalk:

- Angel Trumpet Tree
- Arborvitae
- Bamboo
- Brazilian Pepper Tree
- Cactus
- Dwarf Red Banana
- Esperanza
- Golden Euonymus
- Italian Cypress
- Junipers (other than ground cover varieties)
- Lobelia
- Mimosa
- Mulberry
- Olive Tree
- Salt Cedar
- Sea Green Juniper
- Sweet Olive
- Viburnum
- Yucca

All landscaping is required to be maintained in a healthy and attractive appearance. Proper maintenance includes:

- Mowing
- Pruning and shaping
- Weed control in lawns and planting beds
- Adequate irrigation
- Appropriate fertilization
- Insect and disease control
- Seasonal mulching of planting beds
- Replacement of diseased or dead plant materials

Each yard shall be maintained in a neat, clean and orderly condition by the builder/owner prior to and after the sale of such residence.

Environmental Issues: Harborwalk is located within a sensitive, beautiful, natural setting. To protect that setting, and the wildlife that depends on it, homeowners are encouraged to install and maintain their landscape in an environmentally friendly way:

- Select plants and lawn material that do not require extensive amounts of fertilizers.
- Maintain lawns and plantings using organic products as much as possible.
- Take extra care to prevent introduction of organic materials, lawn clippings, fertilizers, or other chemicals from entering canals.
- Follow manufacturer's recommendations related to application near bodies of water.
- Use of plants that attract butterflies and birds is encouraged.

GRADING

Swales (small ditches) are to be graded shallow, but wide to slow runoff. Avoid steep cuts for a natural look. Steep slopes of 2.5 to 1 or more should be broken with retaining walls or steps. Terracing of lawns is encouraged only when the grades are too steep.

It will be the responsibility of each builder to provide adequate drainage for each home. Caution should be used in establishing the foundation elevation so that adequate drainage between the back yard and front yard is not impaired by driveways or slabs that are constructed too high.

Builders will also be responsible for filling and grading any ruts or other damage to other lots and/or the street ROW caused by construction activities or deliveries.

DRAINAGE

The lots and streets at Harborwalk are designed to drain to the canals. Special care should be taken when grading lots and constructing driveways, walkways and flower beds to prevent damming up the street and right-of-way drainage.

Driveways should slope away from the street where crossing right-of-ways to the property line. Care should be taken to maintain the drainage swales in the drainage easements platted along most side lot lines.

SEDIMENT CONTROL

In order to maintain clean streets and prevent run-off into canals, all projects in Harborwalk are required to practice sediment control during construction. As soon as construction commences a filter silt fence with wire backing shall be installed in such a way as to filter all storm water runoff from the tract into the canals. The fence shall be installed along all property lines abutting a bulkhead, and shall return ten feet (10') from the bulkhead alongside lot lines, including "laydown" areas. The silt fence shall remain in place and in good repair until construction is complete, landscaping is installed, and lawns are established.

Builders shall conform to all regulatory agencies' rules, regulating standards, and criteria governing sediment control to include but not be limited to, EPA-NPDES, City of Hitchcock, and Galveston County pollution control plans. Builders shall be responsible for filing and securing all necessary permits.

UNACCEPTABLE | ACCEPTABLE

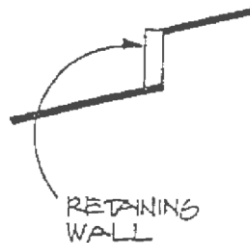
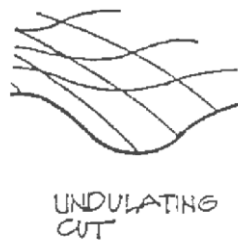
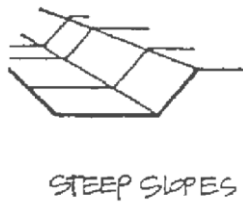
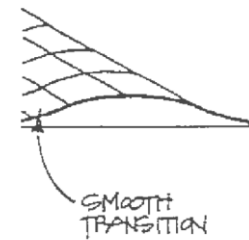
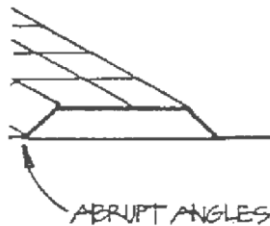

Installation of an irrigation system is mandatory at all lots.

Sprinkler heads should be located to effectively water areas intended with minimum overthrow onto pavement, walks, etc., and to effect 100% overlap insuring effective and even coverage.

Standards:

- Head to Head coverage of system providing 100% coverage.
- Swing joints on all heads should be used to avoid mechanical damage.
- Use hi-pop risers in beds next to walks and driveways keeping rigid risers away from street and driveway curbs to prevent damage from traffic.
- All pressure mains should be Schedule 40 PVC.
- Backflow preventer should be placed out of sight in shrub mass when possible.
- Utilize separately valved sections for shrub and lawn areas which have different water requirements.
- Automatic controllers to be placed in garage or hidden from public view.
- Trenching should be avoided within drip line of existing trees.
- Do not design circuits for more than 75% of maximum pressure.
- Choose best head type for particular application.
- Irrigation by bubblers, drip and leaky pipe is appropriate for some situations.
- Rain sensors to prevent watering during rainstorms and to promote water conservation.

The official submittal of plans and specifications to the Development Review Committee is to provide a review process for conformance to guidelines and standards adopted by the DRC. A clear, direct statement as to acceptability of construction plans is to be made within the review time period not to exceed 24 days. The end result is to ensure compliance with the Builder Guidelines and the Protective Covenants.

All new construction, subsequent construction, remodeling with an exterior component, expansion, and demolition of structures must be reviewed and approved by the DRC prior to commencement of any on-site activity. Additionally, any modifications made to the approved plans while under construction must be submitted and approved prior to implementation. The approval process can be facilitated if complete and high quality submittal documentation is provided to the DRC. The DRC reserves the right to alter the review process in order to ensure an adequate review of all submissions while accommodating the needs of builders and property owners. An additional Plan Review Fee will be charged for reviews or inspections necessary due to re-submissions.

House construction and landscaping must be completed within a one-year time frame.

Refer to Section 6.5 Custom Home Submittal Information for Submittal Process letter, Plan Submittal Form, and Custom Builder Deposit and Fee Schedule.

Refer to Section 6.6 Production Home Submittal Information for Submittal Process letter, Plan Submittal Form, Lot Submittal Form, and Production Builder Deposit and Fee Schedule.

All home builders in Harborwalk must be approved by the DRC. By screening builders and allowing only builders with coastal construction experience an effort is made to achieve a high standard of building quality, enhancing and protecting the value of all the homes in the community.

Builders wishing to construct homes in the community must meet the following requirements to be approved by the DRC:

- Builder must have built at least one home on pilings or columns.
- Builder must maintain general liability insurance with minimum coverage of \$1,000,000 for a single event and \$2,000,000 total coverage.
- Builder must be a member of a Builder's Association (i.e. Galveston County Builders Association)
- Builder must be a member of the Hitchcock Chamber of Commerce.

Submissions for builder approval should be made in letter form to the DRC at the address specified in DRC forms. Submissions should include a reference for at least one home construction on piling or columns, a copy of the builder's certificate of insurance, and documentation of the builder's membership in either GHBA or the Galveston County Builder's Association as well as the Hitchcock Chamber of Commerce.

This section is not intended to limit the ability of a homeowner to build their own home, and applies only to individuals or companies building as a business. If a homeowner builds their own home, they are still required to provide the proof of insurance coverage.

If a Builder repeatedly fails to comply with the Builder Guidelines and/or the Protective Covenants they may be removed from the list of approved builders.

Prior to driving sub-piles and forming for concrete on all projects which touch Building Setback Lines at multiple points, the DRC highly recommends the use of a surveyor to locate all pilings. There have been multiple violations discovered when properties are resold. This can be quite costly for the property owner to correct. Variances are rarely granted.

It should be carefully understood that underground obstructions WITHIN the allowable building footprint exist. Field verify deadmen/tie-back locations along all bulkheads in order to prevent costly repair by the property owner. The Municipal Utility District (MUD) owns and maintains the bulkhead. It also has copies of all as-built maps with underground tie-back location information. Application to the Flamingo Isles MUD is required 60 days before commencement of any construction.

All docks, piers, and boathouses must be self-supporting. Do not attach any structure to the bulkhead system.

Be aware of current NFIP regulations for enclosures, both conditioned and unconditioned, below the Base Flood Elevation. These can have a dramatic effect on the property owner's insurance rates.

Treated wood construction should be used for the first several feet above the slab. Ground floors tend to stay wet a large portion of the year and water will 'wick' up.

Constant high wind in this area will cause moisture penetrations in unlikely areas. Window and door framing should make use of treated materials and extensive flashing should be considered at all areas, especially sills, porches and decks.

When installing tile or slate type materials on any elevated porch or deck, consider using an epoxy grout material. Cement based grouts tend to cause wall streaking and staining for the long term.

Any metal material (steel or aluminum, powder coated or not) will corrode over time. Consider using composite, plastic, or fiberglass materials when available. This includes everything from lighting fixtures to railing.

Exterior ceiling fans are not recommended due to the constant high winds and water exposure in this area. There are many types of portable fans available for use when needed.

Flood lighting for security purposes are only approved when fully shielded and mounted so that they point straight to the ground. Flood lighting may only be mounted so that no light is shining on neighboring property.

All lots (including paving) MUST drain toward the canal. No construction or landscaping is allowed in drainage easements that will block drainage toward the canal. There are no areas that shall be allowed to drain toward the street.

The consideration of installing two water meters (one for the residence and one for the landscaping/pool/etc.) should be made from a budget standpoint.

A final inspection must be performed by the Development Review Committee or its designated representative, and DRC approval must be obtained within thirty (30) days of completion of all work submitted for approval. In addition to the final inspection request and inspection fee, an As-Built survey showing locations of all structures, including fences, must be submitted to the DRC in order for the final inspection to be completed.

The purpose of this inspection is to ensure that the approved drawings were complied with, and that the landscaping and fencing meets the minimum requirements set forth in these Builder Guidelines.

Final inspections will be performed no more than twice each month. If re-inspections are required due to non-compliance the builder/owner will be charged a re-inspection fee.

Builder/Homeowner Plan Submittal Process:

1. Builder/Homeowner must submit 3 sets of plans, 1 PDF of plans, submittal application, compliance deposit and review fees. Fee Schedule is available from the Association Management Office.
 - Plans submitted should include site plan, all floor plans, all exterior elevations, and engineer-sealed foundation plan. Plans for boathouses/piers, landscaping (including plant lists with quantity and sizes), pools, and any other site improvements must also be submitted for approval. Color selections should be recorded on and included with the Submittal Form.
 - Builder/Homeowner may opt to initially submit 2 sets of preliminary plans with the submittal application, compliance deposit and review fees, for a Preliminary Review. Only one Preliminary Review is included in the Review Fee before the final plan submittal (as listed above) is made. Once plans have been submitted for DRC approval, any changes to the plans will require an additional submittal (refer to Deposit and Fee Schedule).
 - Color selections and landscaping plans/lists may be submitted as a later date (as part of the original submittal), but approval must be obtained PRIOR TO INSTALLATION.

Please note that the Compliance Deposit is to ensure complete compliance with those plans approved by the DRC, all Compliance Deposits, less any penalties or deductions for non-compliance, will be refunded upon Final Review by the DRC.

Deposit and Fee Checks should be made payable to ***Harborwalk Property Owners Association, Inc.***

2. Once the DRC review is complete, two (of the three) sets of stamped plans will be returned for permitting with the City of Hitchcock. After permitted, C of H will return one set of stamped, permitted plans to Builder/Homeowner for their records.
3. Builder/Homeowner must request a Final Inspection from the DRC, within 30 days of completion of all work submitted for approval. Along with the final review fee (refer to Deposit and Fee Schedule), Builder/Homeowner must provide DRC with an 'As-Built' survey showing location of all structures, including fences, when requesting a final inspection. Final inspections will be performed twice each month as may be needed. If a re-inspection is required, an additional inspection fee and re-scheduling are required.

Complete submittal packages (application, deposits, fees, 3 copies of plans and PDF of plans), and Final Inspections requests should be submitted, care of the Community Manager to:

Harborwalk DRC
1445 Harborwalk Blvd.
Hitchcock, TX 77563
Phone: 409.935.3737
Fax: 409.935.3936
Email: DRC@harborwalk.com

HARBORWALK

A COASTAL LIFESTYLE COMMUNITY ON WEST BAY

CUSTOM PLAN SUBMITTAL FORM:

Submittal Date: _____ Lot Address: _____ Lot: _____ Block: _____ Sec: _____
Homeowner: _____ Phone: _____
Mailing Address: _____ Email Address: _____

Preliminary Plan Review Requested: _____ Preliminary Plan Review Completed: _____ Final Plan Review Completed: _____
Compliance Deposit Received: _____ Plan Review Fee: _____
Re-Submittal Fee: _____ Final Review Fee: _____

SQUARE FOOTAGE:

Total Sq Ft Lot: _____	Total Sq Ft Air Conditioned: _____
Total Sq Ft Paving: _____	Total Sq Ft Porch (Front): _____
Total Sq Ft House: _____	Total Sq Ft Porch (Rear): _____
Total Sq Ft Lot Coverage: _____	Total Sq Ft Porch (Sides): _____
Lot Coverage (%): _____	Total Sq Ft Porch: _____

EXTERIOR FINISHES:

Siding: _____	Color: _____
_____	_____
Other: _____	Color: _____
Roofing: _____	Color: _____
Piling Type: _____	Finish: _____
Window Type: _____	Finish: _____

MISCELLANEOUS:

No of Stories (Living Area): _____	Maximum Height (Above Center of Street): _____
Landscaping Plans: _____	Pool Plans: _____
Boathouse Plans: _____	_____
Misc. Comments: _____	_____
_____	_____

BUILDER:

Name: _____ Phone: _____
Address: _____ Builder Approval: _____

During and upon completion of construction and landscaping, Builder/Homeowner authorize Harborwalk POA, the DRC Committee, and their agents to enter the property for inspection and enforcement purposes in accordance with the Harborwalk Builder Guidelines.

Signature for Representative: _____ Date: _____

DRC COMMENTS:

DRC APPROVAL:

_____ Approved _____ Conditional Approval _____ Disapproval
(see DRC comments) (substantial changes required)

Signature for Committee: _____ Date: _____

Harborwalk Property Owners Association, Inc. • 1445 Harborwalk Blvd. • Hitchcock, TX 77563

409.935.3737 Office • 409.935.3936 Fax

www.legendcommunitiesinc.com • www.harborwalk.com • www.harborwalkpoa.com

HARBORWALK

A COASTAL LIFESTYLE COMMUNITY ON WEST BAY

MODIFICATION SUBMITTAL FORM:

Submittal Date: _____ Lot Address: _____ Lot: _____ Block: _____ Sec: _____

Homeowner: _____ Phone: _____

Mailing Address: _____ Email Address: _____

Preliminary Plan Review Requested: _____ Preliminary Plan Review Completed: _____ Final Plan Review Completed: _____

Compliance Deposit Received: _____ Plan Review Fee: _____

Re-Submittal Fee: _____ Final Review Fee: _____

EXTERIOR FINISHES:

Siding: _____ Color: _____

Other: _____ Color: _____

Roofing: _____ Color: _____

Piling Type: _____ Finish: _____

Window Type: _____ Finish: _____

MISCELLANEOUS:

No of Stories (Living Area): _____ Maximum Height (Above Center of Street): _____

Landscaping Plans: _____ Pool Plans: _____

Fence Plans: _____ Boathouse Plans: _____

Misc. Comments: _____

BUILDER:

Name: _____ Phone: _____

Address: _____ Builder Approval: _____

During and upon completion of construction and landscaping, Builder/Homeowner authorize Harborwalk POA, the DRC Committee, and their agents to enter the property for inspection and enforcement purposes in accordance with the Harborwalk Builder Guidelines.

Signature for Representative: _____ Date: _____

DRC COMMENTS:

DRC APPROVAL:

_____ Approved _____ Conditional Approval _____ Disapproval
(see DRC comments) (substantial changes required)

Signature for Committee: _____ Date: _____

When construction and landscaping are complete, Builder/Homeowner must request a Final Inspection before closing &/or occupying the residence (refer to Construction Fee Information Sheet). If a re-inspection is required, additional fee and re-scheduling are required. Contact the Community Manager with Final Inspection request at DRC@harborwalk.com, by phone 409.935.3737, or by fax 409.935.3936.

Harborwalk Property Owners Association, Inc. • 1445 Harborwalk Blvd. • Hitchcock, TX 77563

409.935.3737 Office • 409.935.3936 Fax

www.legendcommunitiesinc.com • www.harborwalk.com • www.harborwalkpoa.com

Production Home Submittal Process:

1. For each ‘Master Set’, Builder should submit 3 sets of plans, 1 PDF of plans, submittal application, compliance deposit and review fees (as described in Production Builder Deposit and Fee Schedule below).

* Master Set Submittals:

- Master Plan Set: All floor plans offered including all floor plan options and all elevation options for each plan. Engineer sealed foundation plan must also be provided for each plan.
- Master Boat House/Pier Set: All boathouse/pier combination options including plans and elevations.
- Master Landscaping/Fencing Set: All landscaping and fencing plan options.
- (Optional) Color options for all exterior materials.

* Individual Lot Submittals:

- Specific site plan including lot description, building location, building setbacks, easements, driveway/sidewalk paving locations, pool or any other site improvement, and site coverage.
- Plan/elevation number with any option.
- Boathouse/pier option and location, if applicable.
- Landscaping/fencing option.
- Color selections for exterior materials.

Fee Schedule is available from the Association’s Management Office

Please note that the Compliance Deposit is to ensure complete compliance with those plans approved by the DRC, all Compliance Deposits, less any penalties or deductions for non-compliance, will be refunded upon Final Review by the DRC.

Deposit and Fee Checks should be made payable to **Harborwalk Property Owners Association, Inc.**

2. Once the DRC review is complete, two (of the three) sets of stamped plans with approval letter will be returned for permitting with the City of Hitchcock. After permitted, C of H will return one set of stamped, permitted plans to Builder/Homeowner for their records.
3. When construction and landscaping are complete, Builder must request a Final Inspection before closing &/or the residence is occupied (refer to Fee Schedule). Final inspections will be performed twice monthly as needed. If a re-inspection is required, same fee and re-scheduling are required.

Complete submittal packages (application, deposits, fees, 3 copies of plans and PDF of plans), and Final Inspections requests should be submitted, care of the Community Manager to:

Harborwalk DRC
1445 Harborwalk Blvd.
Hitchcock, TX 77563
Phone: 409.935.3737
Fax: 409.935.3936
Email: DRC@harborwalk.com

HARBORWALK

A COASTAL LIFESTYLE COMMUNITY ON WEST BAY

PRODUCTION PLAN SUBMITTAL FORM:

Submittal Date: _____

BASIC PLAN SQUARE FOOTAGE:

Total Sq Ft Conditioned: _____
Total Sq Ft Porch (Front): _____
Total Sq Ft Porch (Rear): _____
Total Sq Ft Porch (Sides): _____
Total Sq Ft Porch: _____

PLAN / ELEVATION OPTIONS:

Plan Options (Option no. w/ added sq. ft.): _____
Elevation Options: _____

EXTERIOR MATERIALS:

Siding: Field: _____
Accent: _____
Roofing: _____
Piling Type: _____
Window Type: _____

MISCELLANEOUS:

No of Stories (Living Area): _____ Maximum Height (Above Center of Street): _____
Compliance Deposit: _____ Review Fee: _____
Misc. Comments: _____

During and upon completion of construction and landscaping, Builder/Homeowner authorize Harborwalk POA, the DRC Committee, and their agents to enter the property for inspection and enforcement purposes in accordance with the Harborwalk Builder Guidelines.

Signature for Representative: _____ Date: _____

DRC COMMENTS:

DRC APPROVAL:

_____ Approved _____ Conditional Approval _____ Disapproval
(see DRC comments) (substantial changes required)

Signature for Committee: _____ Date: _____

HARBORWALK

A COASTAL LIFESTYLE COMMUNITY ON WEST BAY

PRODUCTION LOT SUBMITTAL FORM:

Submittal Date: _____ Lot Address: _____ Lot: _____ Block: _____ Sec: _____
Homeowner: _____ Phone: _____
Mailing Address: _____ Email Address: _____

Preliminary Plan Review Requested: _____ Preliminary Plan Review Completed: _____ Final Plan Review Completed: _____
Compliance Deposit Received: _____ Plan Review Fee: _____
Re-Submittal Fee: _____ Final Review Fee: _____

LOT COVERAGE:

Total Lot Sq Ft: _____

Total Sq Ft Lot Coverage: _____

Lot Coverage (%): _____

EXTERIOR FINISHES:

Siding: Field: _____

Color: _____

Accent: _____

Color: _____

Trim: _____

Color: _____

Roofing: _____

Color: _____

Piling Type: _____

Finish: _____

Window Type: _____

Finish: _____

MISCELLANEOUS:

Plan Number: _____

Elevation Number: _____

Plan Option Number: _____

Pool Plans: _____

Landscaping Plans: _____

Fence Plans: _____

Boathouse Plans: _____

Misc. Comments: _____

During and upon completion of construction and landscaping, Builder/Homeowner authorize Harborwalk POA, the DRC Committee, and their agents to enter the property for inspection and enforcement purposes in accordance with the Harborwalk Builder Guidelines.

Signature for Representative: _____ Date: _____

DRC COMMENTS:

DRC APPROVAL:

_____ Approved

_____ Conditional Approval
(see DRC comments)

_____ Disapproval
(substantial changes required)

Signature for Committee: _____ Date: _____

HARBORWALK

A COASTAL LIFESTYLE COMMUNITY ON WEST BAY

MODIFICATION SUBMITTAL FORM:

Submittal Date: _____ Lot Address: _____ Lot: _____ Block: _____ Sec: _____
Homeowner: _____ Phone: _____
Mailing Address: _____ Email Address: _____

Preliminary Plan Review Requested: _____ Preliminary Plan Review Completed: _____ Final Plan Review Completed: _____
Compliance Deposit Received: _____ Plan Review Fee: _____
Re-Submittal Fee: _____ Final Review Fee: _____

EXTERIOR FINISHES:

Siding: _____ Color: _____
Other: _____ Color: _____
Roofing: _____ Color: _____
Piling Type: _____ Finish: _____
Window Type: _____ Finish: _____

MISCELLANEOUS:

No of Stories (Living Area): _____ Maximum Height (Above Center of Street): _____
Landscaping Plans: _____ Pool Plans: _____
Fence Plans: _____ Boathouse Plans: _____
Misc. Comments: _____

BUILDER:

Name: _____ Phone: _____
Address: _____ Builder Approval: _____

During and upon completion of construction and landscaping, Builder/Homeowner authorize Harborwalk POA, the DRC Committee, and their agents to enter the property for inspection and enforcement purposes in accordance with the Harborwalk Builder Guidelines.

Signature for Representative: _____ Date: _____

DRC COMMENTS:

DRC APPROVAL:

_____ Approved _____ Conditional Approval _____ Disapproval
(see DRC comments) (substantial changes required)

Signature for Committee: _____ Date: _____

The Harborwalk Builder Guidelines are provided for the community's benefit and the DRC is charged with maintaining compliance to these Guidelines.

When a property owner plans to do any maintenance on the exterior of their house/property, including repainting (same colors), replacing rotten wood, general repair and cleaning, etc., with no actual changes being made to the property, the DRC requests notification of such activity. Upon notification, the DRC will note the work to be completed and the estimated time frame to prevent notification of non-compliance when no approval is required.

HARBORWALK

A COASTAL LIFESTYLE COMMUNITY ON WEST BAY

HOME MAINTENANCE SUBMITTAL FORM:

Submittal Date: _____ Lot Address: _____ Lot: _____ Block: _____ Sec: _____
Homeowner: _____ Phone: _____
Mailing Address: _____ Email Address: _____

EXTERIOR FINISHES:

Siding: _____	Color: _____
Other: _____	Color: _____
Roofing: _____	Color: _____
Piling Type: _____	Finish: _____
Window Type: _____	Finish: _____

PLANNED REPAIRS:

Repairs Comments: _____

MISCELLANEOUS:

Misc. Comments: _____

CONTRACTOR:

Name: _____ Phone: _____
Address: _____ Contractor Agent: _____

During and upon completion of maintenance projects, Contractor/Homeowner authorize Harborwalk POA, the DRC Committee, and their agents to enter the property for inspection and enforcement purposes in accordance with the Harborwalk Builder Guidelines.

Signature for Representative: _____ Date: _____

DRC COMMENTS:

DRC ACKNOWLEDGEMENT:

Signature for Committee: _____ Date: _____

EIGHTH AMENDMENT TO THE
HARBORWALK PROPERTY OWNERS ASSOCIATION
DEVELOPMENT REVIEW COMMITTEE
BUILDER GUIDELINES & ARCHITECTURAL RESTRICTIONS

In accordance with Section 9.02 of the *Cancellation of Existing Reservations, Restrictions, and Maintenance Provisions and Implementation of New Declaration of Covenants, Restrictions, Easements, Charges and Liens of Harborwalk*, the Development Review Committee is amending and restating the *Harborwalk Architectural Controls and Builder Guidelines*.

- “Frequently Asked Questions” has been updated with the following: **What do I need to do before making any changes to the exterior of my existing home? For routine Maintenance?** If a property owner is simply doing routine maintenance such as repainting (same colors), replacing rotted wood, fixing broken louvers, etc. (I.E. not changing anything but simply maintaining it), the no approval is needed. However, if any changes are to be made, by either replacing, changing, or adding to any part of the exterior of the residence, those changes must be submitted for approval before any work is done.
- “1.0 Introduction” has been modified to include the following statement: To the extent that any provisions of this policy are held to be invalid, illegal, unenforceable or in conflict with any provision of applicable law, the validity, legality and enforceability of the remaining provisions shall not in any way be affected or impaired thereby.
- “2.1 Other Permits/Requirements” has been updated to advise property owners that once construction begins on a new residence, that construction must be completed within twenty-four (24) months.
- “2.1 Other Permits/Requirements” has been updated to advise property owners that when a boathouse or pier is constructed before construction on the residence begins, construction on the residence must commence within twenty-four (24) months.
- “2.2 Containment of Debris & Construction Noise” first paragraph, first sentence has been modified to read: All homebuilding activity generates *considerable noise concerns as well as* construction debris and other trash during the construction process.
- “2.2 Containment of Debris & Construction Noise” Amendment 7 adjustment has been modified to define “sunrise” as 6 a.m. on weekdays and 8 a.m. on Saturday, add the definition of “sundown” as when the sun is no longer visible in the sky, and to clarify that ‘quiet’ work may take place at any time once structure has been closed in.
- “2.2 Containment of Debris & Construction Noise” has been modified to allow for pouring of foundations prior to the construction hours upon approval of POA.
- “2.2 Containment of Debris & Construction Noise” has been modified to allow for emergency work to be performed at any time once a building is occupied.
- “2.2 Containment of Debris & Construction Noise” has been modified to include DRC discretion for requirement of homes undergoing considerable remodel or repair to maintain construction fencing.

- “2.2 Containment of Debris & Construction Noise” has been modified to include guidelines for construction parking, advising contractors that roadways should not be used for work/storage space, and roadways must remain clear to allow free flow of traffic.
- “2.4 Signage” has been updated to advise builders to verify the exact logo required before having signs made as a new Harborwalk logo has been issued.
- Section 2.5 Inspections & Enforcement has been added to advise property owners of compliance enforcement, non-compliance notifications, and possible penalties for builders including non-approvals, denial of additional projects in Harborwalk, and penalty fees.
- Section 2.5 Inspections & Enforcement has been added to advise property owners of compliance enforcement, non-compliance notifications, possible penalties, and that a Construction Violation Penalty Fee Schedule has been implemented for construction sites that fall out of compliance and fail to correct the issue(s) within a timely manner. Fees will be deducted from the compliance deposit. Fee Schedule will be separate document subject to change.
- “3.5 Pools and Spas” has been modified to advise property owners that pools may not be installed without an adjacent residential structure. Pool construction may begin prior to the construction of the home, but may not be completed until the residential structure is completed.
- “3.5 Pools and Spas” has been modified to allow pool fences as specified in modified Section 3.7 stated below.
- “3.5 Pools and Spas” has been modified to require that all pool structures be submitted for approval regardless of height.
- “3.5 Pools and Spas” has been modified to allow pool walls to encroach into the fifteen foot (15’) rear building setback up to five foot (5’) easement along the bulkhead. However, pool design and engineering must be coordinated with the Flamingo Isle Municipal Utility District (MUD). If any damage occurs to the existing bulkhead tie-back system, property owner will be responsible for repairs.
- “3.6 Playscapes, Swing Sets, and Flagpoles” has been modified to require all permanent seating benches and/or retaining walls within the rear building setbacks to be submitted for approval.
- “3.6 Playscapes, Swing Sets, and Flagpoles” has been modified to include: additional guidance for display of flags in accordance with Federal and State laws; restriction of flag size to 3’x5’; flagpole material requirements to be permanent, long lasting materials appropriate for the home; flag and flagpoles to be maintained in good condition; and allowance of flag illumination by no more than one (1) halogen landscape light of low beam intensity not to be affect any neighboring property.
- “3.7 Fences” has been modified to allow fence offsets from the bulkhead cap where fence runs adjacent to the bulkhead cap.
- “3.7 Fences” has been modified to require a survey locating newly installed fences, unless the new fence joins existing approved fences on neighboring lots.
- “3.7 Fences” has been modified to allow, in addition to the current approved vinyl fencing, aluminum fencing. Aluminum fencing must be two (2) rail, smooth top, powder coated, black or white, and four feet (4’) tall. Aluminum fencing finish must be maintained. All fencing must be submitted for approval.

- "3.8 Boathouses, Docks & Piers" has been modified to advise property owners of the allowance of touchless boat covers which complement or match the boathouse and residential structure.
- "4.4 Equipment Platforms, Elevator & Lifts" has been modified to advise property owners of guidelines requiring elevators and lifts to be fully enclosed, must be part of or attached to the residential structure, and must match design and color scheme of the structure.
- "4.5 Entrances, Windows & Address" has been modified to include maintenance of window coverings in good condition.
- "4.5 Entrances, Windows & Address" has been modified allowing free-standing address plaques will be allowed in yards if constructed of the same materials as above and are securely placed.
- "4.6 Roofs & Rooftop Elements" has been modified to read: All antennae or satellite dishes must be located as inconspicuously as possible from public view.
- *Solar Energy Devices* has been added and numbered Section 4.7, defines Solar Energy Devices, stipulates requirements for submissions to include proposed location and specifics of device, and potential reasons for denial including: interference with use and enjoyment; threat to health & safety, or violation of law; location not owner's property; location not roof, yard or patio; non-conformity to slope, roofline, color, or visible piping and wiring; and voiding of warranties.
- "4.7 Garages" has been renumbered to Section 4.8 and modified to require no garage door setback at side-loaded garages.
- "5.3 Residential Landscaping" has been modified to clarify the requirement of a minimum of six (6) fifteen (15) gallon shrubs in all rear yards. No trees are required in rear yards.
- "5.4 Minimum Landscape Requirements" has been modified to clarify that any foundation area exceeding twelve inches (12") of exposure must be completely screened with stained concrete or minimum five (5) gallon shrubs.
- "6.1 General Plan Submittal Information" Amendment 7 adjustment of review time period not to exceed twenty-one (21) days has been modified to a 24-day turn around for DRC Review accommodating the schedule of the Architectural Consultant.
- "6.4 Final DRC Inspection" has been modified to the twice a month final inspection schedule of the Architectural Consultant.
- "6.5 Custom Home Submittal Information" have been reformatted to combine Submittal Process and Deposit and Fee Schedule information onto one page. Fee Schedule will be a separate document available from the Association Management Office, and inclusion of statement that deposits will be returned less any penalties or deductions for non-compliance, and revising submission information.
- "6.6 Production Home Submittal Information" have been reformatted to combine Submittal Process and Deposit and Fee Schedule information onto one page. Fee Schedule will be a separate document available from the Association Management Office, and inclusion of statement that deposits will be returned less any penalties or deductions for non-compliance, and revising submission information.

- "6.7 Home Maintenance Work" and Submittal Form has been added for clarification of DRC request for notification of home maintenance, and to provide a simple, uniform way to provide notification.
- All Submittal Forms all forms have been updated to add space for recording of Preliminary plan requests, deposits and fees. Statement authorizing POA, DRC and their agents to enter property for inspection and enforcement purposes. Includes signature line for submitting party.

This instrument was adopted at a duly called meeting of the Board of Directors of Harborwalk Property Owners Association, Inc. on the 29th day of July, 2016, and shall be executed effective the 1st day of September 2016.

HARBORWALK PROPERTY OWNERS ASSOCIATION, INC.

BY: 
Haythem S. Dawlett
President of the Board of Directors

STATE OF TEXAS
COUNTY OF Travis

This instrument was acknowledged before me on the 5th day of August 2016 by Haythem S. Dawlett, President of the Harborwalk Property Owners Association, Inc. Board of Directors

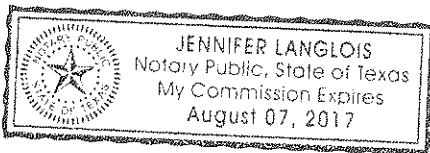

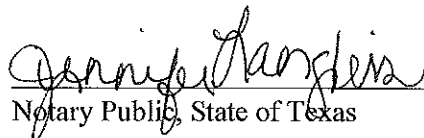
Notary Public, State of Texas
My commission expires: 8.7.17

FILED AND RECORDED

Instrument Number: 2016048854

Recording Fee: 290.00

Number Of Pages: 68

Filing and Recording Date: 08/11/2016 2:08PM

I hereby certify that this instrument was FILED on the date and time stamped hereon and RECORDED in the OFFICIAL PUBLIC RECORDS of Galveston County, Texas.



Dwight D. Sullivan

Dwight D. Sullivan, County Clerk
Galveston County, Texas

NOTICE: It is a crime to intentionally or knowingly file a fraudulent court record or instrument with the clerk.

DO NOT DESTROY - *Warning, this document is part of the Official Public Record.*