

Diagram 6

2225 Foxglove

S.S.

432 PLAN

4435 SQ. FT.

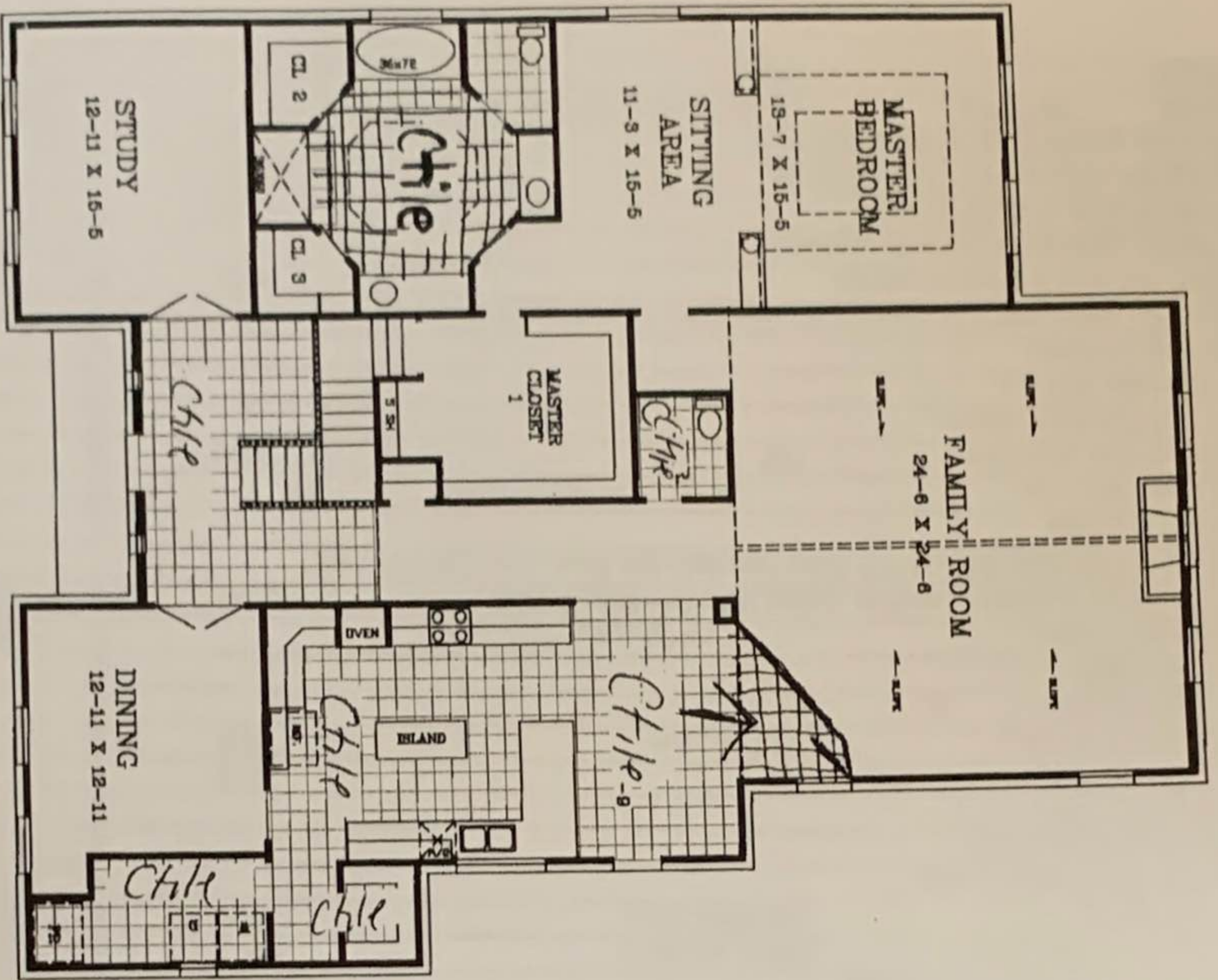

FIRST FLOOR

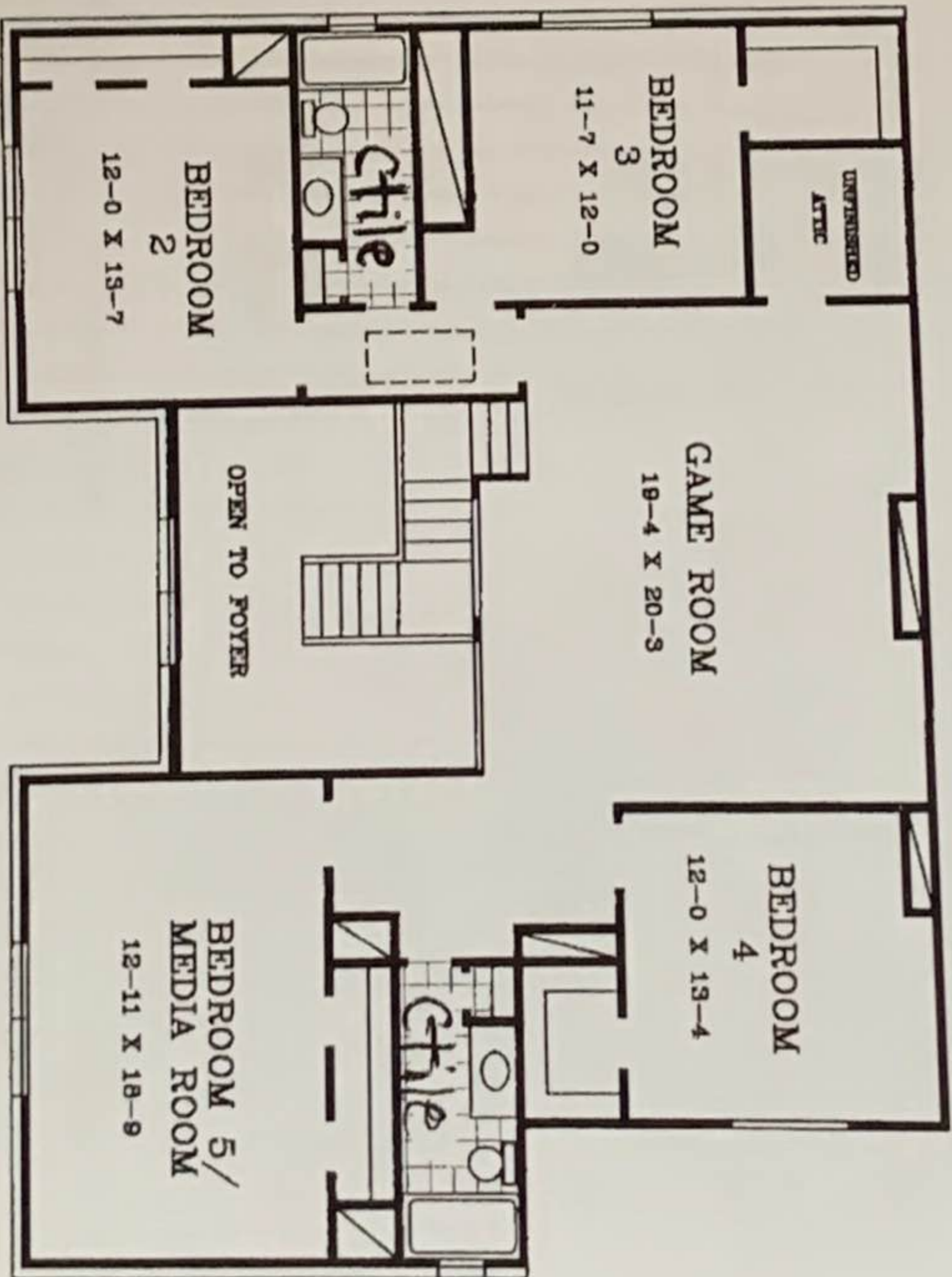

SECOND FLOOR

4BSFPCB+

LEAGUE CITY

CERVELLE HOMES, INC.
P.O. BOX 1468 FREDERICKS, TEXAS 77644

DATE: 5-15-02	4BSFPCB+	PLAN # 4 CAR
DRAWING:		ELEVATION:
LOCATION:	4CAR + BARN STORAGE + FIXED STAIRS + TOTAL BRICK FRONT	
SCALE: 1/8"=1'-0"	REVISED 8-13-02 JOISTS + STORAGE OVER PC	

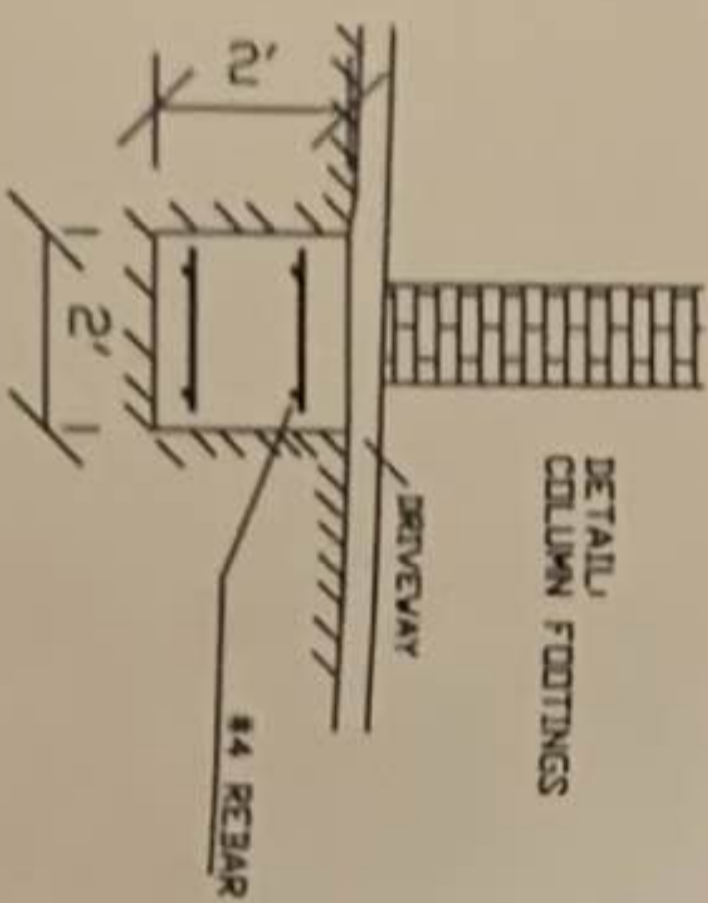
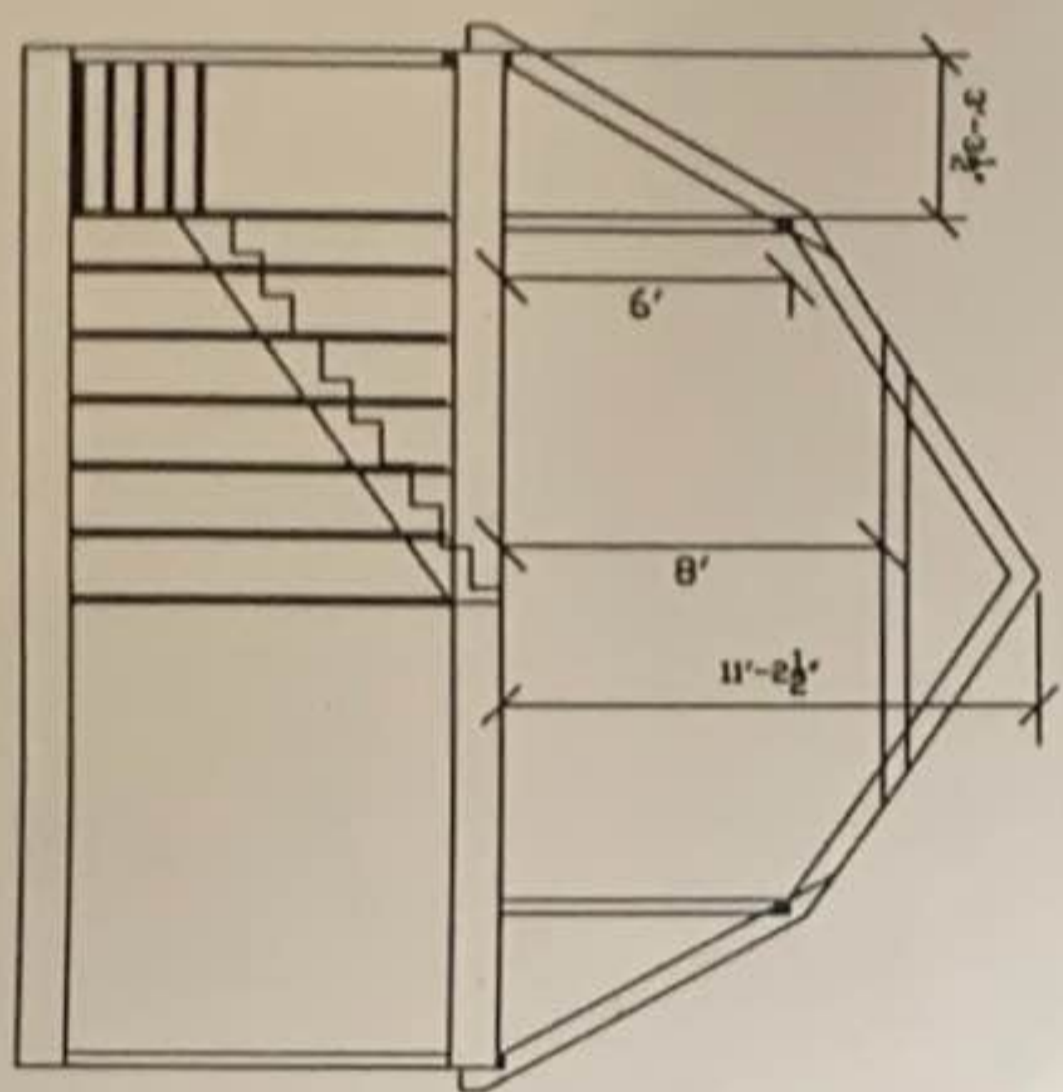
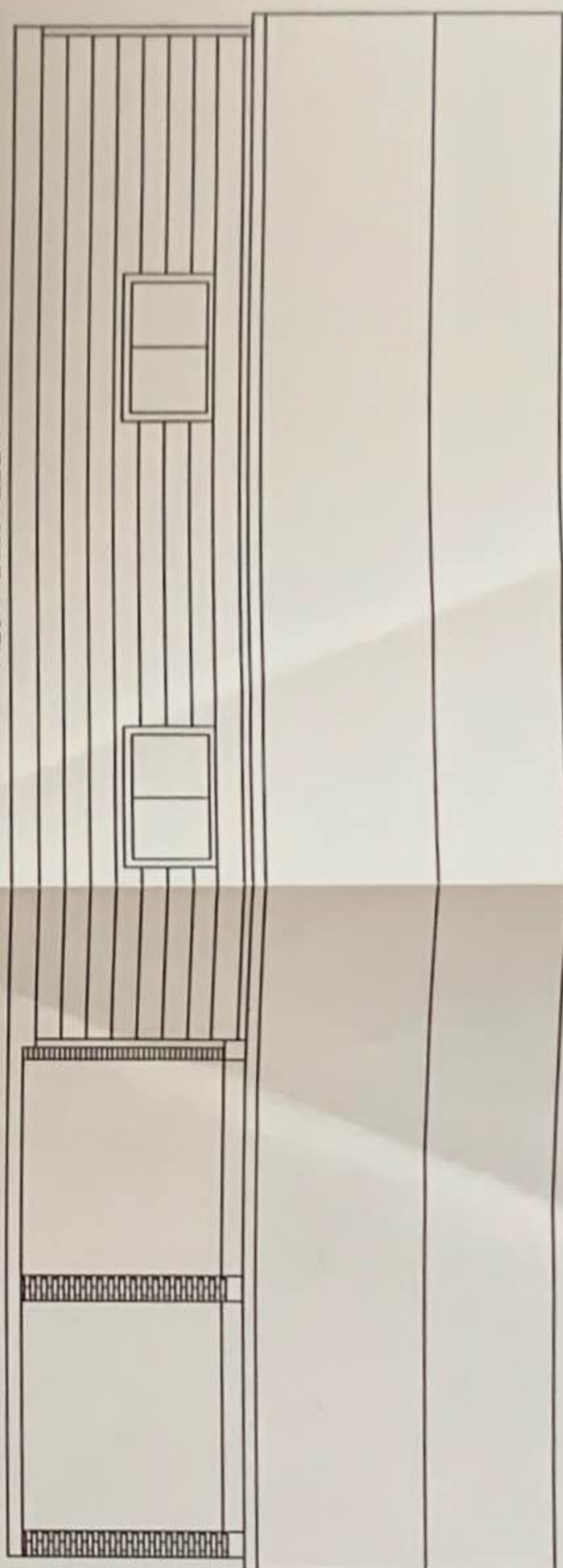

REAR VIEW

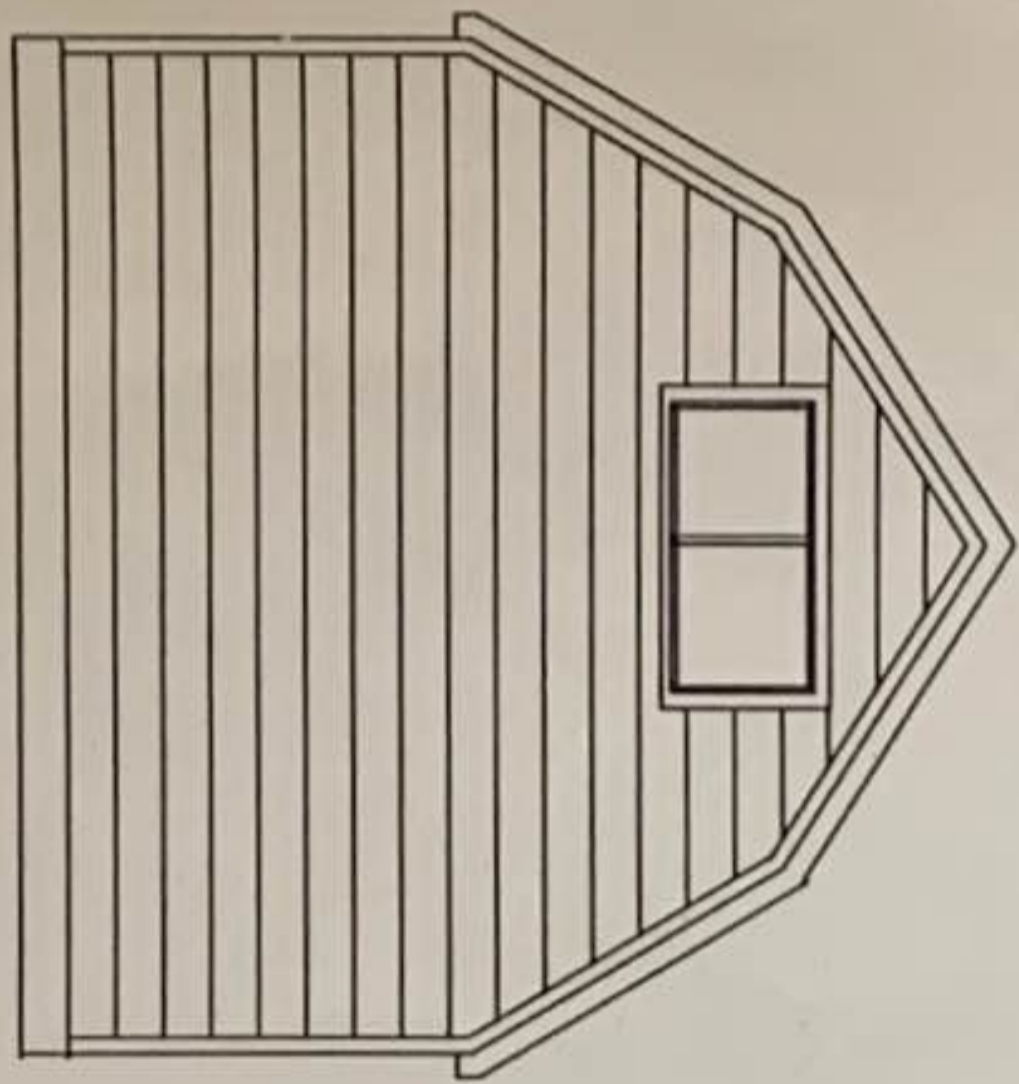

FRONT VIEW

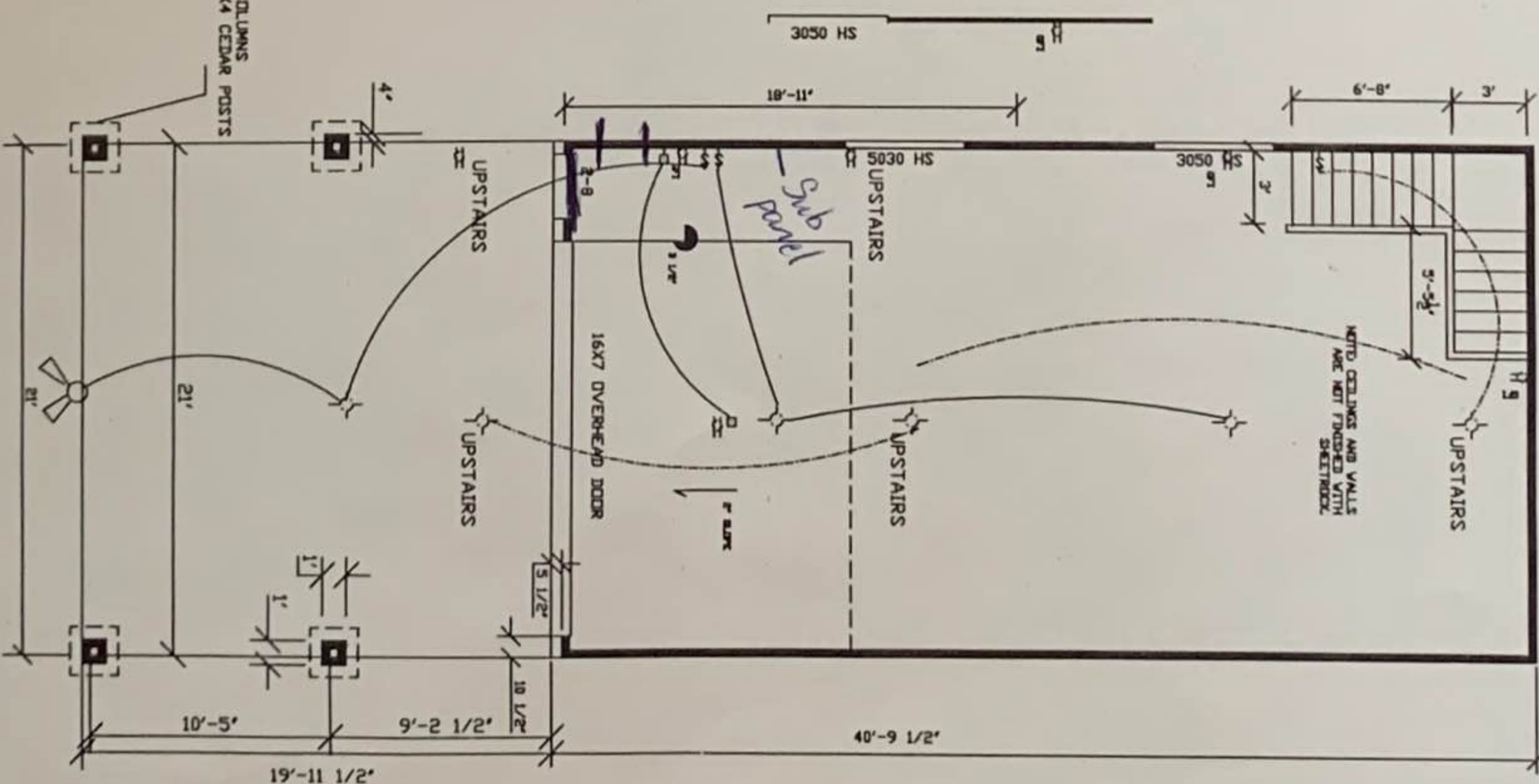
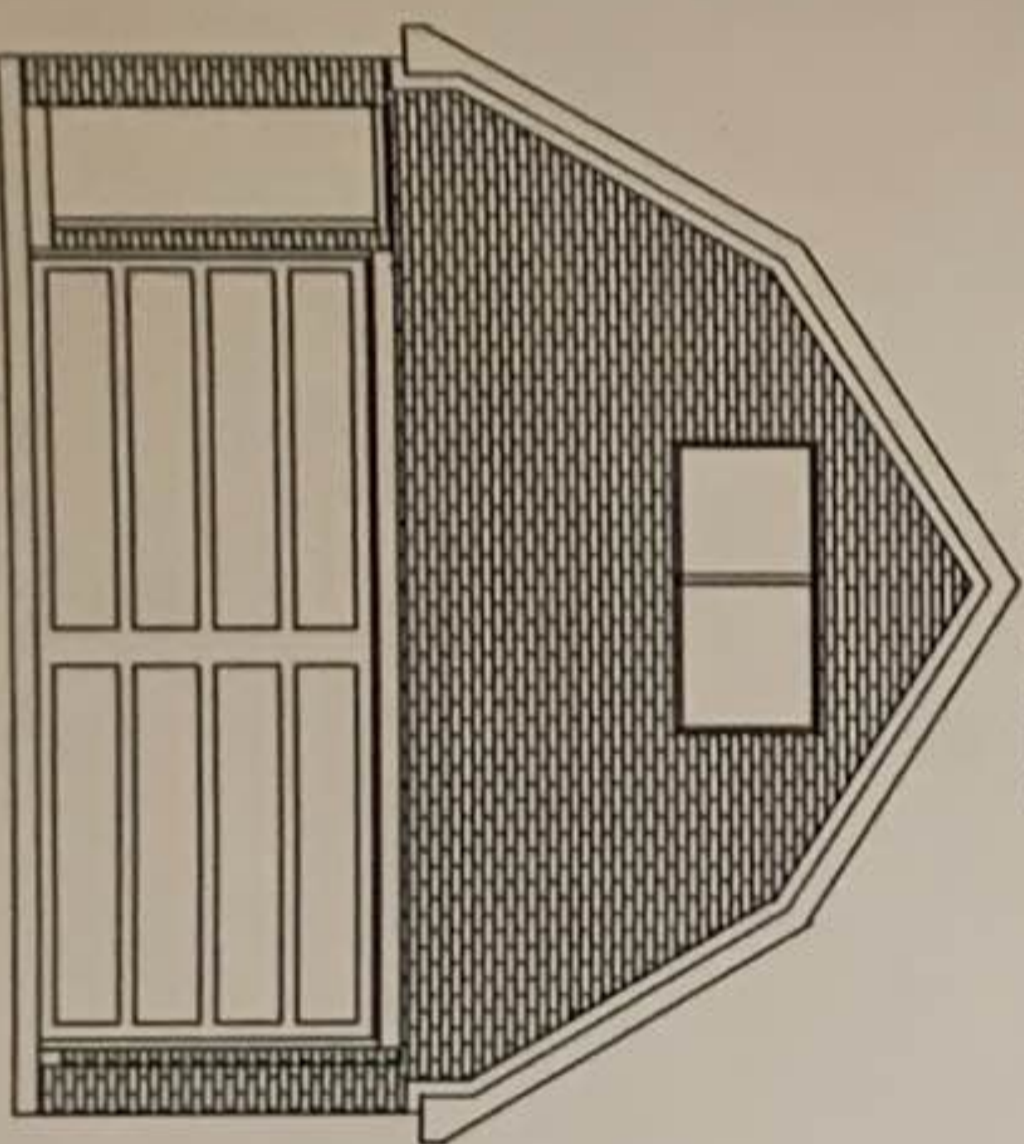

CEILING JOIST LAYOUT

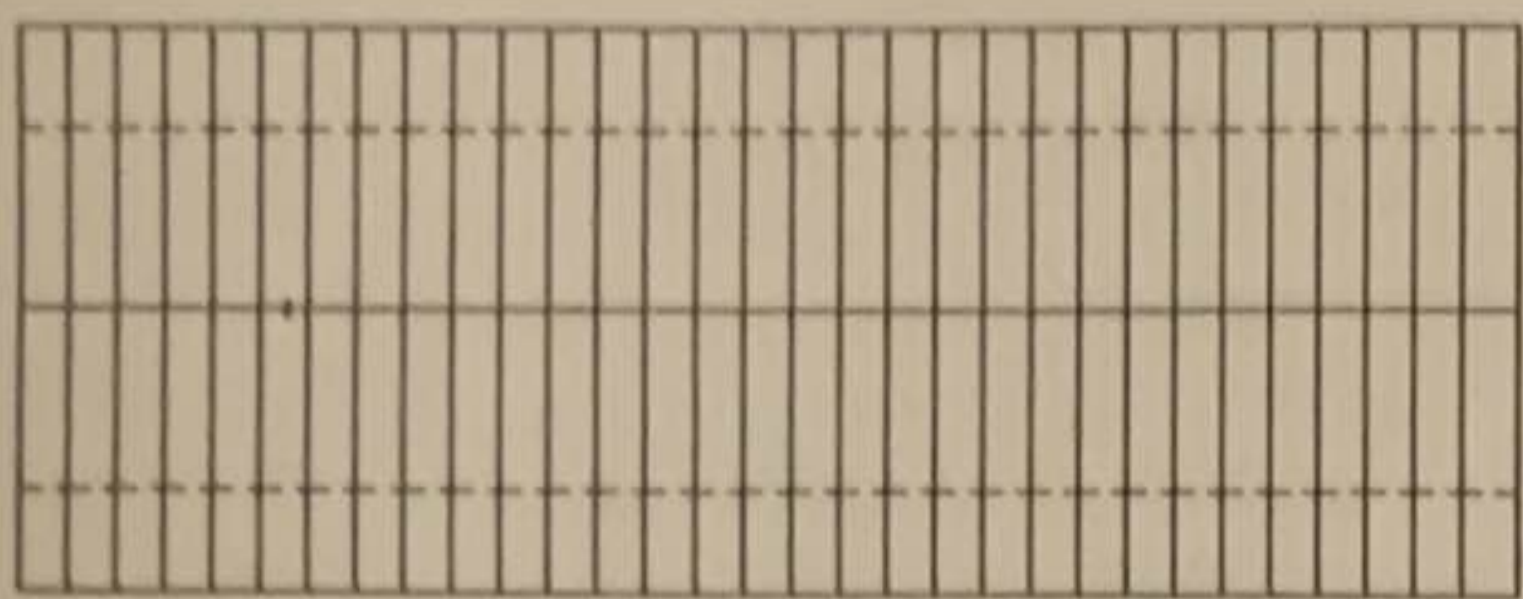

left studs Brick front