



## MECHANICAL INSPECTION

4131 Durness Way  
Houston TX 77025

Monzer Hourani c/o Mandie Peel  
OCTOBER 14, 2020



Inspector

**Daniel Selvidge**

TREC #6120, EDI#TX-173 , TPCL#828156

281-355-9911

[office@heddermanengineering.com](mailto:office@heddermanengineering.com)



# PROPERTY INSPECTION REPORT

Prepared For: Monzer Hourani c/o Mandie Peel

(Name of Client)

Concerning: 4131 Durness Way, Houston TX 77025

(Address or Other Identification of Inspected Property)

Daniel Selvidge - TREC #6120, EDI#TX-173 ,

By: TPCL#828156

(Name and License Number of Inspector)

10/14/2020 12:00

pm (Date)

## PURPOSE, LIMITATIONS AND INSPECTOR / CLIENT RESPONSIBILITIES

This property inspection report may include an inspection agreement (contract), addenda, and other information related to property conditions. If any item or comment is unclear, you should ask the inspector to clarify the findings. It is important that you carefully read ALL of this information.

This inspection is subject to the rules ("Rules") of the Texas Real Estate Commission ("TREC"), which can be found at [www.trec.texas.gov](http://www.trec.texas.gov).

The TREC Standards of Practice (Sections 535.227-535.233 of the Rules) are the minimum standards for inspections by TREC-licensed inspectors. An inspection addresses only those components and conditions that are present, visible, and accessible at the time of the inspection. While there may be other parts, components or systems present, only those items specifically noted as being inspected were inspected. The inspector is NOT required to turn on decommissioned equipment, systems, utility services or apply an open flame or light a pilot to operate any appliance. The inspector is NOT required to climb over obstacles, move furnishings or stored items. The inspection report may address issues that are code-based or may refer to a particular code; however, this is NOT a code compliance inspection and does NOT verify compliance with manufacturer's installation instructions. The inspection does NOT imply insurability or warrantability of the structure or its components. Although some safety issues may be addressed in this report, this inspection is NOT a safety/code inspection, and the inspector is NOT required to identify all potential hazards.

In this report, the inspector shall indicate, by checking the appropriate boxes on the form, whether each item was inspected, not inspected, not present or deficient and explain the findings in the corresponding section in the body of the report form. The inspector must check the Deficient (D) box if a condition exists that adversely and materially affects the performance of a system or component or constitutes a hazard to life, limb or property as specified by the TREC Standards of Practice. General deficiencies include inoperability, material distress, water penetration, damage, deterioration, missing components, and unsuitable installation. Comments may be provided by the inspector whether or not an item is deemed deficient. The inspector is not required to prioritize or emphasize the importance of one deficiency over another.

Some items reported may be considered life-safety upgrades to the property. For more information, refer to Texas Real Estate Consumer Notice Concerning Recognized Hazards or Deficiencies below.

THIS PROPERTY INSPECTION IS NOT A TECHNICALLY EXHAUSTIVE INSPECTION OF THE STRUCTURE, SYSTEMS OR COMPONENTS. This inspection may not reveal all deficiencies. A real estate inspection helps to reduce some of the risk involved in purchasing a home, but it cannot eliminate these risks, nor can the inspection anticipate future events or changes in performance due to changes in use or occupancy. It is recommended that you obtain as much information as is available about this property, including seller's disclosures, previous inspection reports, engineering reports, building/remodeling permits, and reports performed for and by relocation companies, municipal inspection departments, lenders, insurers, and appraisers. You should also attempt to determine whether repairs, renovation, remodeling, additions, or other such activities have taken place at this property. It is not the inspector's responsibility to confirm that information obtained from these sources is complete or accurate or that this inspection is consistent with the opinions expressed in previous or future reports.

ITEMS IDENTIFIED IN THE REPORT DO NOT OBLIGATE ANY PARTY TO MAKE REPAIRS OR TAKE OTHER ACTIONS, NOR IS THE PURCHASER REQUIRED TO REQUEST THAT THE SELLER TAKE ANY ACTION. When a deficiency is reported, it is the client's responsibility to obtain further evaluations and/or cost estimates from qualified service professionals. Any such follow-up should take place prior to the expiration of any time limitations such as option periods.

Evaluations by qualified tradesmen may lead to the discovery of additional deficiencies which may involve additional repair costs. Failure to address deficiencies or comments noted in this report may lead to further damage of the structure or systems and add to the original repair costs. The inspector is not required to provide follow-up services to verify that proper repairs have been made.

Property conditions change with time and use. For example, mechanical devices can fail at any time, plumbing gaskets and seals may crack if the appliance or plumbing fixture is not used often, roof leaks can occur at any time regardless of the apparent condition of the roof, and the performance of the structure and the systems may change due to changes in use or occupancy, effects of weather, etc. These changes or repairs made to the structure after the inspection may render information contained herein obsolete or invalid. This report is provided for the specific benefit of the client named above and is based on observations at the time of the inspection. If you did not hire the inspector yourself, reliance on this report may provide incomplete or outdated information. Repairs, professional opinions or additional inspection reports may affect the meaning of the information in this report. It is recommended that you hire a licensed inspector to perform an inspection to meet your specific needs and to provide you with current information concerning this property.

### **TEXAS REAL ESTATE CONSUMER NOTICE CONCERNING HAZARDS OR DEFICIENCIES**

Each year, Texans sustain property damage and are injured by accidents in the home. While some accidents may not be avoidable, many other accidents, injuries, and deaths may be avoided through the identification and repair of certain hazardous conditions. Examples of such hazards include:

- malfunctioning, improperly installed, or missing ground fault circuit protection (GFCI) devices for electrical receptacles in garages, bathrooms, kitchens, and exterior areas;
- malfunctioning arc fault protection (AFCI) devices;
- ordinary glass in locations where modern construction techniques call for safety glass;
- malfunctioning or lack of fire safety features such as smoke alarms, fire-rated doors in certain locations, and functional emergency escape and rescue openings in bedrooms;
- malfunctioning carbon monoxide alarms;
- excessive spacing between balusters on stairways and porches;
- improperly installed appliances;
- improperly installed or defective safety devices;
- lack of electrical bonding and grounding; and
- lack of bonding on gas piping, including corrugated stainless steel tubing (CSST).

To ensure that consumers are informed of hazards such as these, the Texas Real Estate Commission (TREC) has adopted Standards of Practice requiring licensed inspectors to report these conditions as "Deficient" when performing an inspection for a buyer or seller, if they can be reasonably determined.

These conditions may not have violated building codes or common practices at the time of the construction of the home, or they may have been "grandfathered" because they were present prior to the adoption of codes prohibiting such conditions. While the TREC Standards of Practice do not require inspectors to perform a code compliance inspection, TREC considers the potential for injury or property loss from the hazards addressed in the Standards of Practice to be significant enough to warrant this notice.

Contract forms developed by TREC for use by its real estate license holders also inform the buyer of the right to have the home inspected and can provide an option clause permitting the buyer to terminate the contract within a specified time. Neither the Standards of Practice nor the TREC contract forms require a seller to remedy conditions revealed by an inspection. The decision to correct a hazard or any deficiency identified in an inspection report is left to the parties to the contract for the sale or purchase of the home.

INFORMATION INCLUDED UNDER "ADDITIONAL INFORMATION PROVIDED BY INSPECTOR", OR PROVIDED AS AN ATTACHMENT WITH THE STANDARD FORM, IS NOT REQUIRED BY THE COMMISSION AND MAY CONTAIN CONTRACTUAL TERMS BETWEEN THE INSPECTOR AND YOU, AS THE CLIENT. THE COMMISSION DOES NOT REGULATE CONTRACTUAL TERMS BETWEEN PARTIES. IF YOU DO NOT UNDERSTAND THE EFFECT OF ANY CONTRACTUAL TERM CONTAINED IN THIS SECTION OR ANY ATTACHMENTS, CONSULT AN ATTORNEY.

### **ADDITIONAL INFORMATION PROVIDED BY INSPECTOR**

*Hedderman Engineering Inc.:*

>It is the purpose of this report to give our client my educated and experienced opinion of the condition and function of the stated property as visually inspected by Hedderman Engineering Inc. The inspection performed on this property is of a general nature and includes the following systems: electrical, mechanical, and plumbing. This does not include any specialized inspections and/or inspections of any hazardous materials (such as done in environmental inspections) or any of the following; structural systems, mold, audio/visual components, hazardous materials and gases, rated walls, lead paint, destructive insects or pest, security items, water or air treatment systems, etc. This inspection is limited to those components which were visible and accessible at the time of the inspection. It is noted that this report contains the opinions of this inspector of the stated property as it appeared on the day of the inspection and is in no way a warranty of any component in the days and future following the inspection. All mechanical

components are judged on the basis of age, condition, and the function of those items as they appeared on the day of the inspection and are not guaranteed to continue functioning in that manner in the future. It is recommended that the our client purchase a home warranty policy to protect oneself from both unexpected and anticipated problems that may occur in the future.

>It is noted that Hedderman Engineering Inc. is not responsible for any problems found in the house during or after components are opened up, disassembled, uncovered, made visible, or made accessible by another entity after the inspection is completed.

>If a builder or service contractor examines an area of question and comes to the conclusion that there is no repair needed, have them present to you in writing that the item is in compliance with a prevailing code and is functioning properly, not in need of repair.

>It is the intent of this inspector to work in compliance with the Standards Of Practice For Real Estate Inspectors. It is not required of this company to exceed these standards. You may obtain a copy of the document referred to above by contacting the Texas Real Estate Commission. It is also noted that this inspection is not a "code inspection", but rather an inspection of the condition and function of the stated property.

>Although this report may include observations of some building code violations, total compliance with mechanical, plumbing, electrical codes, specifications, and/or legal requirements are specifically excluded. We do not perform "code" inspections, and since building codes change every few years, our inspections are not performed with the intention of bringing every item in the property into compliance with current code requirements. Rather, the standard of our inspections is a performance standard to determine if the items inspected are functioning at the time of the inspection, or are in need of repair. This is particularly applicable to Home Warranty policies, where the standards of the Home Warranty service company are often different than our stated performance standard for judging whether a piece of equipment is functional or in need of repair. If you intend to rely on a Home Warranty policy, then it is recommended that you contact the appropriate service companies for a more in-depth analysis of what may be required to meet their standards should a claim be made against the policy.

>If there are any questions or concerns please contact Hedderman Engineering, Inc. at 281-355-9911 or Office@HeddermanEngineering.com.

## I. STRUCTURAL SYSTEMS

- A. Foundation**  
*Comments:*
- B. Grading and Drainage**  
*Comments:*
- C. Roof Covering Materials**  
*Comments:*
- D. Roof Structures & Attics**  
*Comments:*
- E. Walls (Interior and Exterior)**  
*Comments:*
- F. Ceilings and Floors**  
*Comments:*
- G. Doors (Interior and Exterior)**  
*Comments:*
- H. Windows**  
*Comments:*
- I. Stairways (Interior and Exterior)**  
*Comments:*
- J. Fireplaces and Chimneys**  
*Comments:*
- K. Porches, Balconies, Decks and Carports**  
*Comments:*

The structural portions of this property were inspected by an engineer from Hedderman Engineering Inc. per the inspection agreement between this firm and our client. All comments regarding the structure and property grade are found in the structure report that is created and provided by the engineers at Hedderman Engineering Inc.

According to HAR, the house was built in 1954.

*Orientation - House Facing North:*

For the purpose of the inspection, North is considered to be the front of the house.

I	NI	NP	D
---	----	----	---

## II. ELECTRICAL SYSTEMS

**A. Service Entrance and Panels**

*Comments:*

*Electrical System Description :*

The electrical service is provided by a 120/240 volt, single-phase, 200-ampere overhead service to an electric meter located at the rear of the house.

### Electrical Wiring Information

<u>Service Wires</u>	<u>Branch Circuit Wires</u>	<u>Grounded or Ungrounded System</u>
2/0 Copper	Copper	Grounded

### Breaker Panel Information

<u>Location</u>	<u>Manufacturer</u>	<u>Rating</u>
Rear	Square D	200 amps

Circuit Breaker Wiring Diagram

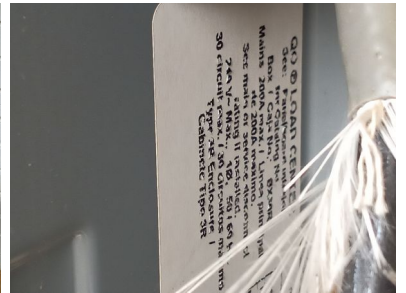
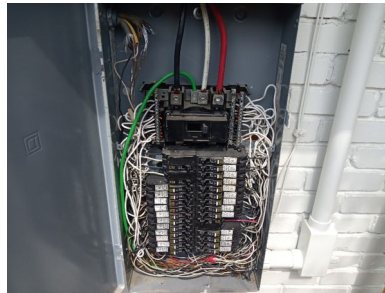
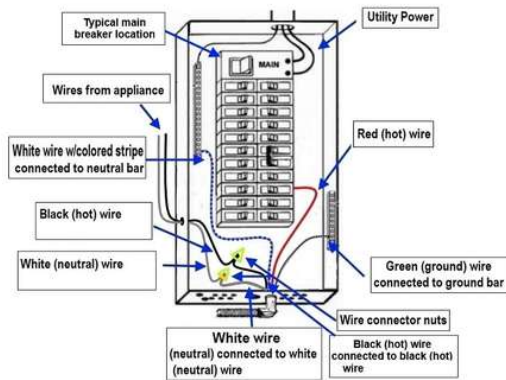

I	NI	NP	D
---	----	----	---

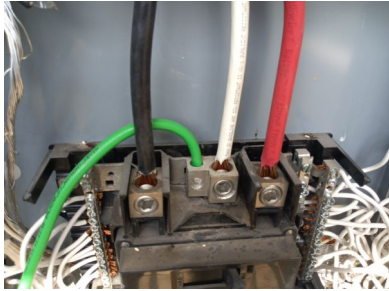

**Breakers - Routine Check:**

It is a general recommendation that all circuit breakers be tripped off and on at least once a year to ensure that they are still physically able to trip off. Occasionally, the points on a breaker will fuse to the main bus in the panel, preventing the breaker from tripping off, even if there is an overload on the circuit. If this condition occurs, it can be a fire hazard.

**AFCI breakers- Not tripped off:**

The Arc Fault Circuit Interrupters in the panel were not operationally tested due to the house being occupied. Sudden loss of power can damage some electronic equipment, therefore, as a policy we do not trip off breakers inside an occupied house. If further investigation is desired, it is recommended that a service company be contacted when the house is not occupied or all of the electronics are unplugged.

**1: Breaker - Double lugged**

A breaker was observed inside the panel with more than one wire attached. Each wire should be on its own breaker.

**Obtain Cost Estimate**

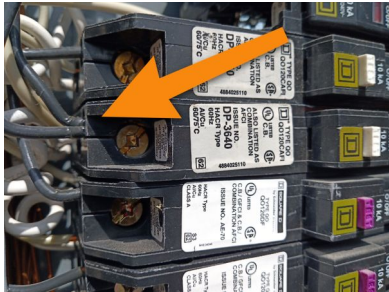

**2: Wires - Terminated improper**

Wires that were improperly terminated were observed in the breaker panel box. The purpose of the wires was not determined. Further investigation is reconected with an electrician.

**Obtain Cost Estimate**

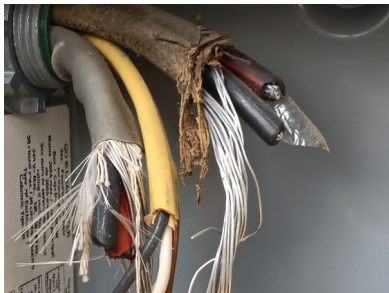

**B. Branch Circuits, Connected Devices, and Fixtures**

*Comments:*

*Type of Wiring: Copper - Non-metallic sheathed*

*GFCIs - Functional:*

I	NI	NP	D
---	----	----	---

Outlets that were protected by ground fault circuit interrupt (GFCI) devices were present and functioning properly at the time of the inspection. The GFCI devices were checked and the power to the outlets turned off when the test buttons were pressed. It is pointed out that GFCI devices can stop tripping/resetting properly at any point and should be tested periodically and replaced when necessary. Locations included: kitchen, bathrooms, exterior of the house

*Light Fixtures - Functional:*

The light fixtures throughout the house were operated and were observed to be functional at the time of the inspection.

*Outlets - Some inaccessible:*

Some of the receptacle outlets in the home were inaccessible and could not be reached for inspection due to furniture, heavy storage items, personal effects, or conditions outside the control of the inspector.

*Exterior Light Fixtures - Sensors/Timers:*

Several of the exterior lights appeared to be on a daylight sensor or timer, and will not come on until it gets dark. Since it was not dark, the lights were not checked at the time of the inspection. Further investigation is recommended.

**1: Outlet - Ungrounded**

Garage

A three prong outlet that was not grounded properly and needs to be repaired. It is recommended that an electrician be contacted, and the necessary repairs made to the outlet.

**Obtain Cost Estimate**

**2: Smoke and Carbon Monoxide Detectors**

We could not determine if the smoke and/or carbon monoxide detectors are connected to the security alarm system as is common practice, therefore, to avoid triggering the security alarm we did not operationally check each device. Further investigation is recommended with a service company who specializes in this field to determine if the devices are interconnected as currently required and functioning properly. For safety purposes, it is recommended that smoke detectors and carbon monoxide detectors be replaced every ten years. Further investigation is recommended.

**3: Low Voltage Systems - Not inspected**

It is pointed out that low voltage systems, low voltage wiring, and low voltage connections were not included in the scope of the inspection and were not checked, including: audio/visual systems, alarm systems, data lines, and phone lines. If further investigation is desired, it is recommended that a service company be contacted.

**4: Ceiling Fan - No remote control**

Front bedroom

The remote control for one or more of the ceiling fans were not present and the fans could not be operated.

**Further investigation is recommended**

**III. HEATING, VENTILATION & AIR CONDITIONING SYSTEMS**

**A. Heating Equipment**

*Comments:*

*Type of System: Forced Air*

*Energy Sources: Natural gas*

*Gas Furnace Description :*

I	NI	NP	D
---	----	----	---

The heating for the property was provided the following natural gas-fired equipment:

<u>ZONE</u>	<u>BRAND</u>	<u>BTU</u>	<u>DATE</u>	<u>LOCATION</u>
West	Trane	60k	2009	Attic
Easy	Trane	60k	2009	Attic

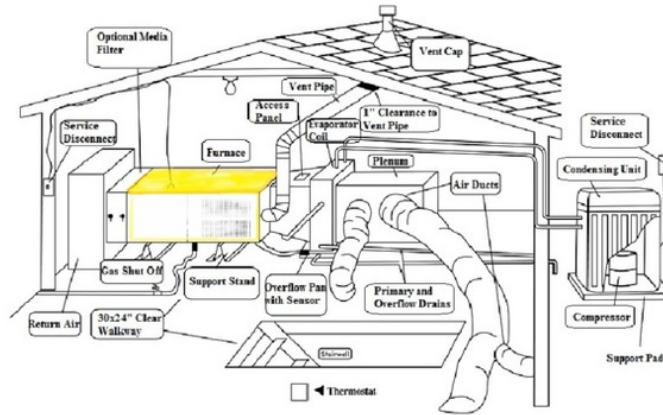

*Heating Equipment - Functional:*

The heating equipment was observed to be operating and functional at the time of the inspection. The heating equipment responded to the thermostat and the equipment appeared to be heating the air adequately.

*Heat Exchanger - Information:*

Gas furnaces are constructed in such a way that the units must be dismantled in order to view the entire heat exchanger inside. The equipment was not dismantled, and the heat exchanger was not able to be viewed for evidences of cracks. If further investigation is desired, it is recommended that a service company be contacted to dismantle the equipment. It is pointed out, for safety purposes, the heat exchanger should be inspected by an HVAC service company once a year.

*Limited visual inspection:*

It is pointed out that our inspection of the air conditioning and heating system(s) is a limited, visual inspection where we check the equipment as it has been installed to determine whether or not the system(s) is cooling and/or heating at the time of the inspection. Our inspection is necessarily a cursory inspection, as we do not determine the sizing, adequacy, or design of any component in the system, or the compatibility of the individual components, nor the installation of the system(s) to be in conformity to the latest building code requirements. If you desire an in-depth analysis of the HVAC system(s), then it is recommended that a service company be contacted to analyze the system(s). This is particularly important if the system(s) is an older system and has only a limited amount of remaining life due to its age and/or condition.

**B. Cooling Equipment**



I	NI	NP	D
---	----	----	---

*Comments:*

*Type of System: Split system*

*A/C Equipment Description :*

The type of air conditioning for the property is a forced air split system. The cooling equipment for the property was as follows:

Zone	Brand	Size/Age Condenser	Size/Age Coil	Temp Drop
West	Trane	3-ton 2007	3-ton 2016	20
East	Trane	3-ton 2010	3-ton 2016	20

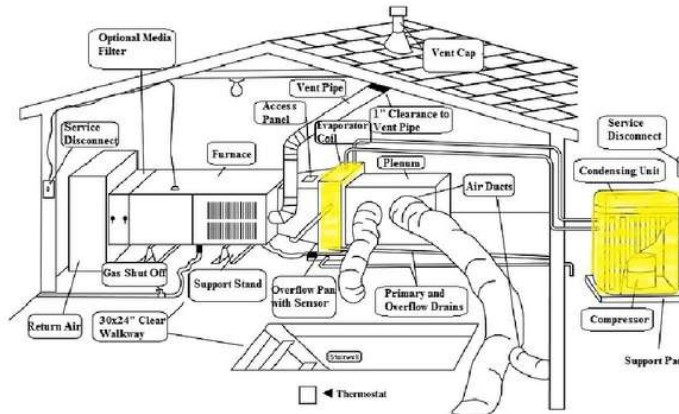

*Condensing Unit Equipment - Functional:*

The condensing unit equipment was functional at the time of the inspection. The equipment responded to the corresponding thermostat, and the compressor components and fan motor components were operating.

*Condensing Unit Equipment - Limited Life:*

Due to the age and/or condition of the equipment, it is our opinion that the equipment has only a limited amount of life remaining. It would be prudent to have the equipment thoroughly checked by a licensed air conditioning service company and further investigation is recommended.

Both units

*Coil Equipment - Functional:*

The coil equipment was operating and was providing a degree of cooling at the time of the inspection.

*Cooling Performance - Acceptable :*

The cooling performance of the equipment was observed to be adequate according to industry standards. The air conditioning equipment was observed to be cooling between 16-20 degrees across the indoor coil at the time of the inspection.

I	NI	NP	D
---	----	----	---

Both systems

*Cooling Performance:*

We measure the temperature drop ( $\Delta T$ ) across the indoor coil(s) at the time of the inspection and our observations have been recorded in this report. It is pointed out that our measurements of the cooling performance of the equipment is only at a "point in time", and cannot reflect whether the equipment has been recently serviced, or what the future performance of the equipment will be after the day of the inspection. Further investigation with the homeowner is recommended to determine when the equipment was last serviced.

**1: R22 Refrigerant**

East unit

The condensing unit label indicate that the equipment operates with the old R-22 refrigerant, rather than the currently required R410A refrigerant. R-22 is no longer the current standard in the industry and will be more expensive to refill when servicing. It is recommended that a service company be contacted for further investigation.

**Further investigation is recommended**



**2: Overflow Pan - Rust**

Both coils

Rust was observed in the overflow pan under the coil, apparently due to water backing up at the primary drain line and overflowing into the pan. No water was observed in the overflow pan at the time of the inspection, however since the equipment was only operated for a short time during the inspection, It is recommended that the primary drain line and the coil be checked by an air conditioning service company.

**Obtain Cost Estimate**



**C. Duct System, Chases, and Vents**

*Comments:*

*Type:* Flex ducts

*Duct Work - Acceptable:*

The ductwork appeared to be in good condition at the time of the inspection and air was blowing out of each of the registers. The airflow may need to be adjusted in each room to meet your specific needs.

*Return Air - Acceptable :*

The return air system in the house had no visible items that were in need of repair and appeared to be performing as intended at the time of the inspection.

I	NI	NP	D
---	----	----	---

*Media filter Equipment:*

Media filter equipment was installed for the HVAC system(s) in the attic. It is pointed out that when a media filter is installed, a filter should not be installed at the return air grill in the living space. Also, media filters need to be replaced periodically.



### IV. PLUMBING SYSTEMS

**A. Plumbing Supply, Distribution Systems, and Fixtures**

*Comments:*

- Location of water meter: The street curb
- Location of main water supply valve: East side of house
- Static water pressure reading: 45 PSI
- Water Supply Material: PEX

A plumbing system typically consists of three major components, including the potable water supply piping; the waste or drain piping; and the plumbing fixtures. The distribution piping brings the water from the public water main or a private well to the individual fixtures throughout the house. The water distribution system is under pressure, usually from 40 psi to 70 psi. The waste or drain piping carries the waste water and products underground to the sewer system or septic tank, and the waste piping is not under pressure, but operates by gravity flow. We typically run water down the drains from the sinks, tubs, showers, and toilets, but this cannot simulate the waste flow characteristics of full occupancy. There may be partial blockage of the underground waste lines from debris, broken pipes, or tree roots that cannot be detected by a visual inspection. If you desire a more in-depth inspection, it is recommended that you contact a qualified plumber.

*Shut Off Valve - Exterior location:*

The shut-off valve for the main inlet water line was located at the exterior of the house.

East side of house



**1: Shower/Tub - Shower head leak**

Front bathroom

The shower head was leaking at the connection and needs to be repaired.

**Obtain Cost Estimate**

I	NI	NP	D
---	----	----	---

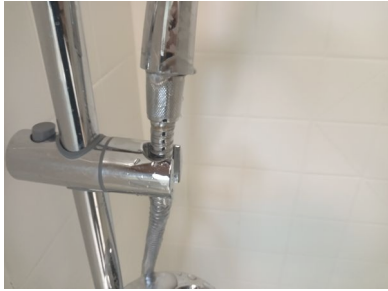

**B. Drains, Wastes, & Vents**

*Comments:*

*Sewer Piping Material: PVC*

*Sewer System - Functional:*

No items requiring repair were visible for the operation of the drain system at the time of the inspection. No evidences of a system wide problem were observed when the system was operationally checked by running water through each of the plumbing fixtures during the duration of the inspection.

It is noted that most of the drain waste system in the walls, under the floors, and in the ceilings is not visible. If further investigation is desired, it is recommended that a plumber be contacted to perform an in depth survey with a camera or hydrostatic test.

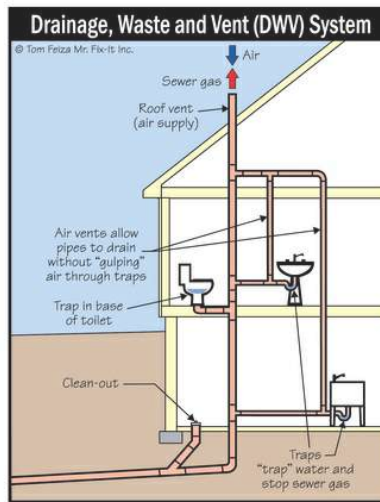

*Sewer Clean Out - Not visible:*

A clean out for the sewer line was not visible, and it is recommended that you check with the owner for the location. This is needed for access to the sewer line should the line become clogged and need to have a snake run down the line to clean it out.

*Sewer Lines - PVC:*

The visible above ground sewer piping at the crawlspace under the house was observed to be PVC.

The sewer piping appeared to be installed properly and no leaks were visible when we ran water down the piping during the crawlspace inspection.



I	NI	NP	D
---	----	----	---



**C. Water Heating Equipment**

*Comments:*

*Energy Source: Natural gas*

*Capacity: 180 gallons per hour*

*Tankless Water Heater description:*

The hot water for the property was provided by a tankless water heater. The water heater is as followings:

<u>Location</u>	<u>Brand</u>	<u>Capacity</u>	<u>Age</u>	<u>Energy Type</u>
Attic	Rinnai	180 gph	3-5 Years	Gas

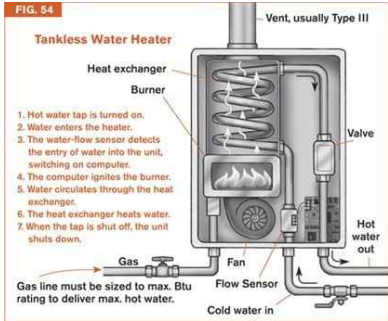

*Water Heater Equipment - Functional:*

The water heater equipment was functional at the time of the inspection and providing hot water to the applicable plumbing fixtures.

*Temp/Pressure Relief Valve - Information :*

Temperature/pressure relief valves are not operationally checked by this firm during the inspection.

Valves typically do not reseat properly when they are operated, which causes the valves to leak. It is best to replace the temperature/pressure relief valves for water heaters every 2-3 years to prevent them from getting clogged with mineral deposits.

**D. Hydro-Massage Therapy Equipment**

*Comments:*

*Hydro - therapy equipment was not present at the time of the inspection. :*

**E. Gas Supply System**

*Comments:*

*Gas Meter Location :*

The main gas shut off valve was located at the inlet side of the gas service meter. A secondary shut off

I	NI	NP	D
---	----	----	---

valve was located at the rear of the house.

Rear garage

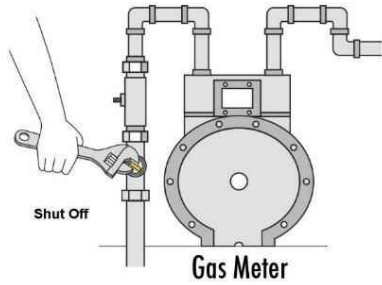

*Gas System Inspection :*

A cursory visual inspection was performed on the gas supply piping. The inspection was limited to the gas pipes that were visible and accessible at the time of the inspection. The use of specialized equipment to detect leaks is not included in the scope of this inspection, nor is determining the gas supply pressure or adequacy. If further investigation is desired, it is recommended that a plumber be contacted.

**1: Gas supply line - Not supported/secured**

Rear of garage

A gas supply line that was not properly supported/secured and needs to be repaired was observed.

**Obtain cost estimate**



**V. APPLIANCES**

**A. Dishwashers**

*Comments:*

*Functional :*

The dishwasher was functioning and responded to the controls. The unit was run through a cycle at the time of the inspection and appeared to be operating properly.

**B. Food Waste Disposers**

*Comments:*

*Functional:*

The disposal was operating and responded to the controls at the time of the inspection.

**C. Range Hood and Exhaust Systems**

*Comments:*

*Range Vent - Functional:*

I = Inspected    NI = Not Inspected    NP = Not Present    D = Deficient

I	NI	NP	D
---	----	----	---

No items requiring repair were visible at the time of the inspection to the operation of the range vent. The vent fan was observed to be venting properly at the time of the inspection.

**D. Ranges, Cooktops, and Ovens**

*Comments:*

*Gas Cooktop - Functional:*

The gas cooktop was functioning and responded to the controls when they were operated. All of the burners and controls were operating properly at the time of the inspection.

*Oven - Calibrated properly:*

No repair was needed to the calibration of the oven thermostat. The thermostat was set at 350 degrees, and the oven heated to within the allowable  $\pm 25$  degrees. The oven was checked with an oven thermometer and found to heat to 350 degrees.

**E. Microwave Ovens**

*Comments:*

*Functional:*

No items requiring repair were visible at the time of the inspection for the heating operation of the microwave. A cup of water was placed in the unit, and the microwave heated the water adequately. It is pointed out that the unit was not checked for microwave leakage.

**F. Mechanical Exhaust Vents and Bathroom Heaters**

*Comments:*

*Mechanical Vents - Functional:*

The mechanical vent fans were functional at the time of the inspection. The bath vent fans responded to the switches and were functional at all the bathrooms.

**G. Garage Door Operators**

*Comments:*

*Functional - Autoreverse and sensors:*

The garage door opener equipment was functional at the time of the inspection and opened/closed when the controls were operated. The auto-reverse mechanism was operational, and the sensitivity setting on the mechanism was adequate. Also, the infrared auto reverse mechanism was functional.

**H. Dryer Exhaust Systems**

*Comments:*

**1: Vent - Termination unknown**

The dryer vent was not visible once it entered the wall cavity and it could not be determined if the vent was an approved material or if it terminated in an approved manner. Further investigation is recommended. It is noted that an improperly installed dryer vent is considered a fire hazard and sometimes will not permit the dryer to operate properly.

---

**2: Flexible Vent Pipe**

The dryer vent was observed to be a flexible vent material rather than a rigid sheet metal vent pipe. This is considered a fire hazard as lint can back up inside of the flexible vent material at the ribs. It is recommended that the flexible vent material be replaced within approved material.

**Obtain Cost Estimate**

I	NI	NP	D
---	----	----	---



I. Other

*Comments:*

*Non Built-in Equipment - Not inspected :*

It is pointed out that non built-in refrigerators, wine coolers, small refrigerators, clothes washers, and clothes dryers are not included in the scope of this inspection and were not checked. If further investigation is desired, it is recommended that a service company be contacted.

**Further investigation is recommended**

*Dryer Connection - No Gas - Electric 4 prong:*

The 240-volt outlet for the electric dryer connections was observed to be the newer style 4-prong outlet rather than the older 3-prong outlet. You may want to check your clothes dryer to determine if you have the correct power cord for this outlet. A gas connection was not installed.

## VI. OPTIONAL SYSTEMS

A. Landscape Irrigation (Sprinkler) Systems

*Comments:*

*Sprinkler System:* Rachio, Located inside garage, 10 zones -

An automatic sprinkler system was installed. The system included a control panel, one or more solenoid valves, underground water lines and with sprinkler heads.



*Backflow Prevention Device - present:*

A backflow prevention device was present and was equipped with the two water shut off valves on the water supply line to the sprinkler system.

*System - Operational:*

No items requiring repair were visible at the time of the inspection in the operation of the individual zones. The control panel was functional, all zones were observed to be operating, and all the heads were observed to be spraying adequately.





*Rain Sensor:* Rain Sensor - Present -

It is currently required for automatic sprinkler systems to be equipped with a rain sensor device that will prevent the sprinkler system from operating during and shortly after a significant rain.

## INFORMATION FROM HEDDERMAN ENGINEERING INC.

*Closing Comments :*

Opinions and comments stated in this report are based on the apparent performance of the items included within the scope of the inspection, at the time of the inspection. Performance standards are based on the knowledge gained through the experience and professional studies of the inspector. There is no warranty or guarantee, either expressed or implied, regarding the habitability, future performance, life, merchantability, and/or need for repair of any item inspected. It is recommended that a Home Warranty Policy be provided to protect the appliances and mechanical equipment against unforeseen breakdowns during the first year. Check with your agent for details.

Items identified in the report as Deficient and our Recommendations are provided in the above report. Many, but not all, recommendations are highlighted in bold red text. It is our intention, and your responsibility, that you follow up on these deficiencies and recommendations as part of your due diligence by contacting the appropriate service contractor for **Further Investigation, Obtain cost estimate, and/or Contact the builder.** It is pointed out that other related and/or underlying conditions may be present, and which may not be apparent without further investigation.

As an additional service, we strongly recommend using a new tool we have on our website that can quickly turn your inspection report into an easy-to-read estimate of repairs for a nominal fee. These pricing reports from a third party company called Repair Pricer not only make the inspection report easy to understand in terms of dollars and cents, but they are also useful negotiation tools. Just visit the page below on our website and upload your report into Repair Pricer. If you have any questions when you receive your report, you can contact them at [info@repairpricer.com](mailto:info@repairpricer.com) <http://www.heddermanengineering.com/repair-cost-estimates>