

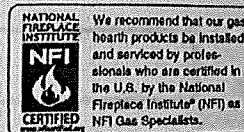

RG A 2-72

INSTALLATION AND OPERATION GUIDE FOR



HARGROVE GAS LOGS

Ember Burner (EB) & H-Burner (HB)

For model number and PFS seal refer to attached nameplate.

Installation and service must be provided by a qualified installer, service agency or the gas supplier.

NOTE: ADEQUATE FIREPLACE VENTILATION IS REQUIRED FOR SAFETY
READ INSTRUCTIONS FULLY BEFORE INSTALLING OR OPERATING
INSTALLER: LEAVE THESE INSTRUCTIONS WITH CONSUMER!

Hargrove gas logs are made with refractory materials. Each log is hand-finished to assure the most realistic, detailed log available. The gas log burner system is designed to burn like wood, with a smoky flame. For this reason, the gas log set must be burned only in a fully vented, non-combustible fireplace with the dampers completely open and the chimney free of any obstructions or restrictions. The fireplace must be designed and approved to burn wood.

The realistic yellow flame produces carbon monoxide and soot. Under normal conditions, these products are exhausted up the chimney. If fumes or soot, from the gas burning, are evident in the room when the damper is fully open it indicates that the fireplace draft is defective. Do not operate your gas log set until the fireplace draft is corrected.

FOR YOUR SAFETY

Do not store or use gasoline or other flammable vapors and liquids in the vicinity of this or any other appliance.

FOR YOUR SAFETY

WHAT TO DO IF YOU SMELL GAS

1. Do not try to light any appliance.
2. Do not touch any electrical switch; do not use the phone in your building.
3. Immediately call your gas supplier from a neighbor's phone. Follow the gas supplier's instructions.
4. If you cannot reach your gas supplier, call the fire department.

WARNING: If the information in this manual is not followed exactly, a fire or explosion may result causing property damage, personal injury or loss of life.

It is the homeowner's responsibility to assure their fireplace has adequate draft

RECOMMENDED BURN-IN PERIOD

Hargrove gas logs are made of special refractory materials, which withstand high temperatures. One characteristic of this material is retention of moisture. For this reason, we recommend burning the logs for only fifteen minutes during the first burning. After allowing the logs to cool for at least one hour, the set can be burned for any length of time.

WARRANTY

Hargrove gas logs carry a limited lifetime warranty against breakage in the original fireplace. Warranty does not include labor. Burners and grates are warranted for five years. Valves and pilot systems carry a two-year limited warranty in the original fireplace. Outdoor installations carry a one-year limited warranty. See limited warranty information (pg. 13) for complete details.



INSTALLATION AND OPERATION MANUAL

ENGLISH | FRANÇAIS | ESPAÑOL

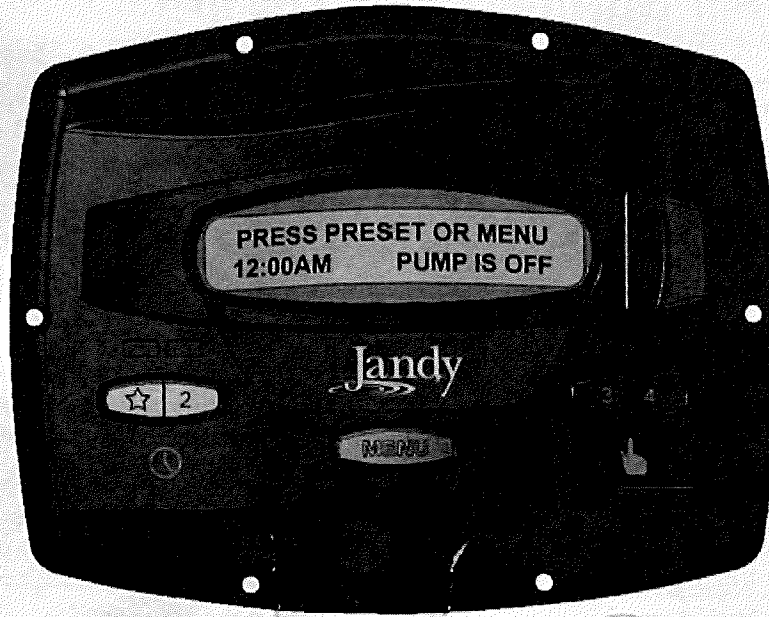

Jandy Pro Series JEP-R

Variable-Speed Pump Digital Controller

For use with Jandy Pro Series Variable-Speed Pumps

For Indoor or Outdoor Installations

⚠ WARNING

FOR YOUR SAFETY - This product must be installed and serviced by a contractor who is licensed and qualified in pool equipment by the jurisdiction in which the product will be installed where such state or local requirements exist. The maintainer must be a professional with sufficient experience in pool equipment installation and maintenance so that all of the instructions in this manual can be followed exactly. Before installing this product, read and follow all warning notices and instructions that accompany this product. Failure to follow warning notices and instructions may result in property damage, personal injury, or death. Improper installation and/or operation will void the warranty.

Improper installation and/or operation can create unwanted electrical hazard which can cause serious injury, property damage, or death.



ATTENTION INSTALLER - This manual contains important information about the installation, operation and safe use of this product. This information should be given to the owner/operator of this equipment.

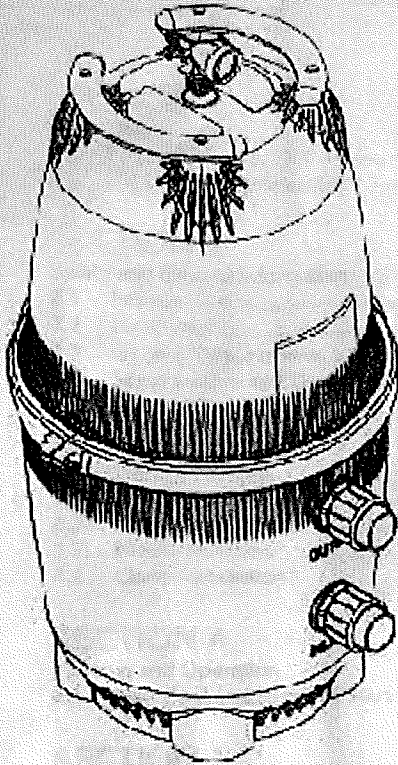

Jandy Cartridge Pool Filters

CL Series Filters

Installation and Operation Manual

FOR YOUR SAFETY - This product must be installed and serviced by a professional pool/spa service technician. The procedures in this manual must be followed exactly. Improper installation and/or operation can create dangerous high pressure which can cause the filter lid to be blown off, possibly causing death, serious injury or property damage. Improper installation and/or operation will void the warranty.

WARNING - Before installing this product, read and follow all warning notices and instructions that accompany this filter. Failure to follow warning notices and instructions may result in property damage, serious injury, or death.

Jandy®

H0238700C



waterpik

6000 Condor Drive, Moorpark, CA, USA 93021 • 707.776.8200 FAX 707.763.7785
480 S. Service Road West, Oakville, Ontario, Canada L6K 2H4 • 905.844.8233 FAX 905.844.2635
Litho in U.S.A. © Water Pik Technologies, Inc. 2003
For Technical Support call 707-776-8200, ext. 260



INSTALLATION AND OPERATION MANUAL

ENGLISH | FRANÇAIS | ESPAÑOL

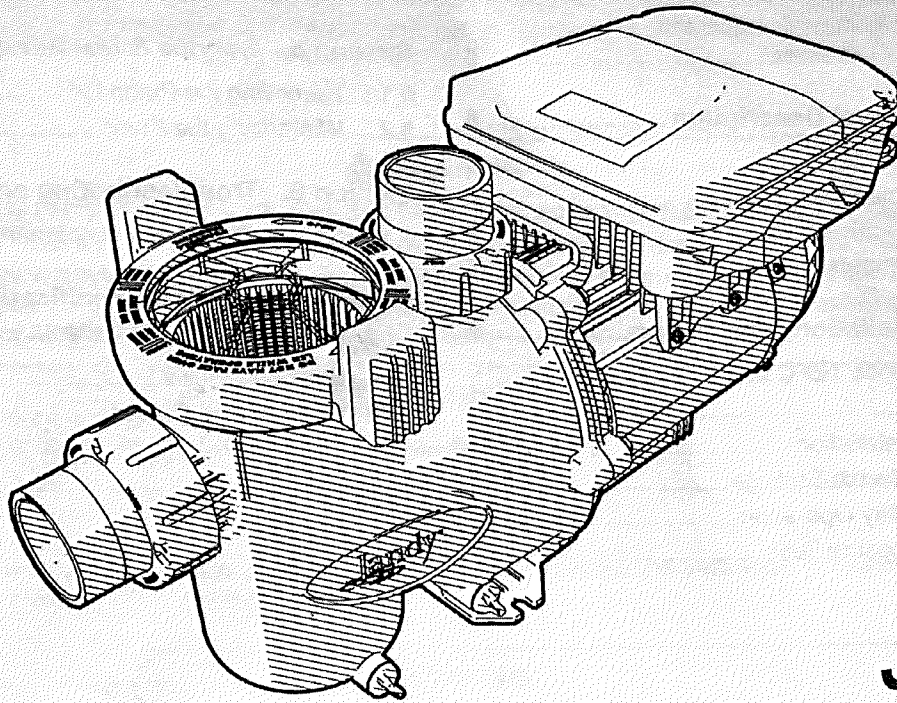

Jandy Variable-Speed Pumps

VSFHP185DV2A
VSFHP270DV2A
VSPHP270DV2A
VSSHP220DV2A
VSSHP270DV2A



⚠ WARNING

FOR YOUR SAFETY - This product must be installed and serviced by a contractor who is licensed and qualified in pool equipment by the jurisdiction in which the product will be installed where such state or local requirements exist. The maintainer must be a professional with sufficient experience in pool equipment installation and maintenance so that all of the instructions in this manual can be followed exactly. Before installing this product, read and follow all warning notices and instructions that accompany this product. Failure to follow warning notices and instructions may result in property damage, personal injury, or death. Improper installation and/or operation will void the warranty.



Improper installation and/or operation can create unwanted electrical hazard which can cause serious injury, property damage, or death.

ATTENTION INSTALLER - This manual contains important information about the installation, operation and safe use of this product. This information should be given to the owner/operator of this equipment.

Rainsoft Division of Aquion, Inc.
101 S. Gary Ave
Roselle, Illinois 60172
1.847.437.9400 or 1.800.860.7638
www.rainsoft.com

Ultrrefiner II

Premium Drinking Water System



RainSoft®

Taking the Worry Out of Water ...Since 1953



This product is manufactured in an ISO 9001:2015 certified facility.



Model Ultrrefiner II - FMV - BNFP, Ultrrefiner II - FMV - BNFV, Ultrrefiner II - FMV - CHFP and Ultrrefiner II - FMV - CHFV are tested and certified by NSF International against NSF/ANSI standard 42 and 58 for the reduction of claims specified on the performance data sheet. Refer to the manufacturer's Performance Data Sheet for the specific reduction claims.

Model Ultrrefiner II - FMV - BNFP, Ultrrefiner II - FMV - BNFV, Ultrrefiner II - FMV - CHFP and Ultrrefiner II - FMV - CHFV are tested and certified by NSF International against to CSA B483.1 Standard.

Not approved for use in California. Please request California-specific product literature from your local RainSoft Dealer.



www.rainsoft.com

Part No.: 16778

Rev: N 12/2017

Rainsoft Division of Aquilon, Inc
101 S. Gary Ave
Roselle, Illinois 60172
1.847.437.9400 or 1.800.860.7638
www.rainsoft.com

RainSoft®

Taking the Worry Out of Water ...Since 1953

EC4 SERIES WATER TREATMENT SYSTEM WITH DC CONTROL

Owner's Manual



This product is manufactured in an ISO 9001: 2008 certified facility.



The EC4 series is tested and certified by the WQA to NSF/ANSI 44 for the specific performance claims as verified and substantiated by test data. See the performance data sheet for specific reduction claims.

The EC4 series is tested and certified by WQA to NSF/ANSI 372 for "lead free" compliance.

The EC4 series is tested and certified by WQA to CSA B483.1 Standard.

Part No: 16928

Rev. B 03/17

QUALITY WATER & AIR

What Water & Air Were Meant to Be

QUALITY WATER & AIR is proud to offer the very best in water treatment systems, air purification systems, and tankless water heaters. You will save time and money while providing the very best living environment for your family.

We have the equipment, expertise, experience and dedication required to

meet your needs. Our goal is to ensure that each customer is completely satisfied with every aspect of our products and service.

QUALITY WATER & AIR is committed to providing outstanding service that will give you what you deserve: **"THE BEST LIFE HAS TO OFFER!"**

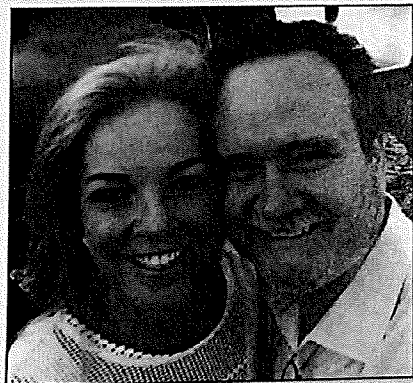

Owners Bill & Tonya McGraw

*Recipients of the BBB's
Top Service Awards*

Bill and his wife, Tonya, opened their environmental products business in 1989. Bill and his team of professionals receive the Better Business Bureau's top awards each year because of his staff's concentration on and dedication to outstanding customer service.

Award-Winning Service



Pinnacle Winner



Winner of Distinction

2015	2012
2014	2010
2013	2008

Experienced and Dependable

- Installed and serviced residential and commercial environmental equipment for the Greater Houston Area *since 1989*.
- *Over 60,000* established and satisfied customers.

Association Memberships and Licensing

- Greater Houston Better Business Bureau
- Texas Water Quality Association
- National Water Quality Association
- Licensed under the TCEQ (The Texas Commission on Environmental Quality)
- Texas Master Plumber's License #10640

Conroe — 936.756.4999
114 Commercial Circle, Conroe, TX 77304

www.qualitytx.com

Houston — 281.955.3400
11055 Neeshaw Drive, Houston, TX 77065

FIREMAGIC®

POWER BURNER

DIAMOND SERIES

INSTALLATION AND OPERATING INSTRUCTIONS

INSTALLER: Leave these instructions with consumer.

CONSUMER: Retain for future reference.

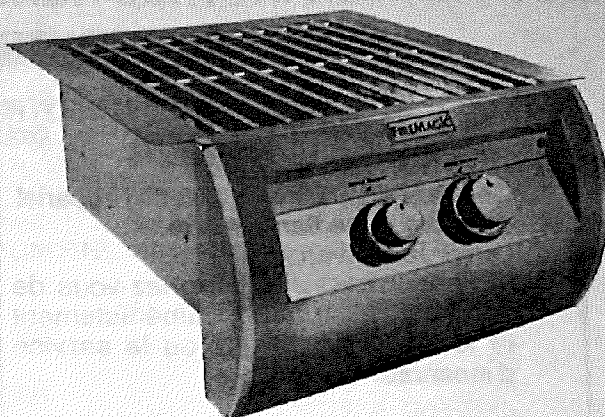

Important: READ THESE INSTRUCTIONS CAREFULLY BEFORE STARTING INSTALLATION

SAFETY WARNINGS & CODES

▲ DANGER

IF YOU SMELL GAS:

1. Shut off the gas to the appliance.
2. Extinguish any open flame.
3. Open lid.
4. If odor continues, keep away from the appliance, and **immediately** call your gas supplier or fire department.

▲ WARNING

1. Do not store or use gasoline or other flammable vapors and liquids in the vicinity of this or any other appliance.
2. A propane cylinder not connected for use shall not be stored in the vicinity of this or any other appliance.

WARNING

Improper installation, adjustment, alteration, service, or maintenance can cause injury or property damage. Refer to this manual. For assistance or additional information consult a qualified professional installer, service agency, or the gas supplier.

CODE AND SUPPLY REQUIREMENTS: This power burner must be installed in accordance with local codes and ordinances, or, in the absence of local codes, with either the latest *National Fuel Gas Code (ANSI Z223.1/NFPA 54)*, and *Natural Gas and Propane Storage and Handling Installation Code (CSA-B149.1)*.

This appliance and its individual shutoff valves must be disconnected from the gas supply piping system when testing the system at pressures in excess of ½ psig (3.5 kPa).

This appliance must be isolated from the gas supply piping system by closing its individual manual shutoff valves during any pressure testing of the gas supply system at pressures up to and including ½ psig (3.5 kPa).

Certified to: ANSI Z21.58a-2008
CSA 1.6a-2008



09-41

Robert H. Peterson Co. • 14724 East Proctor Avenue, • City of Industry, CA 91746

SERIAL # _____

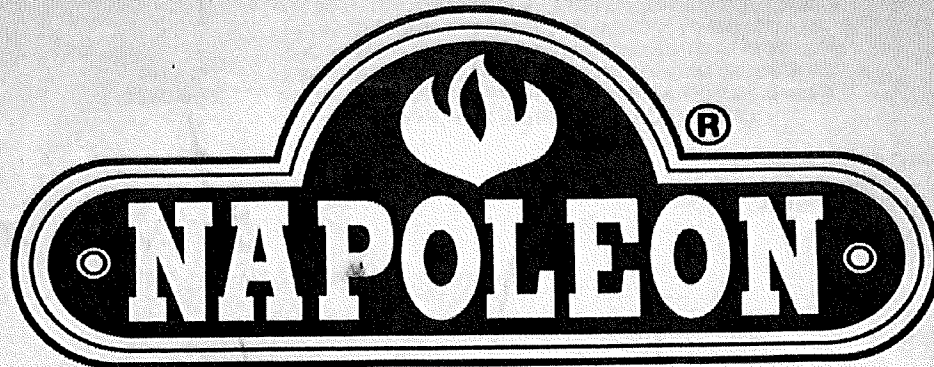

877
7013
4079
3600

GOURMET GRILLS

Award Winning Products

BUILT-IN UNIT INSTRUCTION GUIDE

Please use this manual in conjunction with your main manual to properly assemble your built-in grill. Refer to the main manual for operating, cleaning, and maintenance instructions. This grill is designed for **NON-COMBUSTIBLE** enclosures only, and must be installed and serviced by a qualified installer to local codes.

BUILT IN PROPANE GAS HOOK-UP: The piping up to the gas grill is the responsibility of the installer and piping should be located as shown in the built-in instructions. Do not use hose to connect the unit. It must be connected with either rigid pipe, copper tube or an approved flexible metal connector. The installation must comply with CAN B149.1 Natural Gas and Propane installation code in Canada, or to the National Fuel Gas code, ANSI Z223.1 in the United States. The minimum recommended piping size is NPS 1/2" for rigid pipe, and 1/2" OD for copper tubing (based on a 20 ft run). Longer runs may require larger sizes to conform with local codes or to conform with CAN B149.1. Propane Gas Installation Code in Canada or to the National Fuel Gas Code, ANSI Z223.1 in the United States. The gas supply must be connected to the 3/8" flare fitting located under the right hand side of the control panel. If installing a side burner, a separate line must be branched off to the side burner unit and enter the side burner opening at the specified location. If the enclosure is to house a propane cylinder, the tank portion of the enclosure must be ventilated according to local codes, and must not have communication with the cavity used to enclose the gas grill. A propane tank can not be stored below the gas grill.

BUILT IN NATURAL GAS HOOK-UP: The piping up to the gas grill is the responsibility of the installer and piping should be located as shown in the built-in instructions. Do not use hose to connect the unit. It must be connected with either rigid pipe, copper tube or an approved flexible metal connector. The installation must comply with CAN B149.1 Natural Gas and Propane Installation Code in Canada, or to the National Fuel Gas Code, ANSI Z223.1 in the United States. The minimum recommended piping size is NPS 1/2" for rigid pipe, and 5/8" OD for copper tubing (based on a 20 ft run). Longer runs may require larger sizes to conform with local codes or to conform with CAN B149.1. Natural Gas Installation Code in Canada or to the National Fuel Gas Code, ANSI Z223.1 in the United States. The gas supply must be connected to the 3/8" flare fitting located under the right hand side of the control panel. If installing a side burner, a separate line must be branched off to the side burner unit and enter the side burner opening at the specified location.

Built in units are supplied with a drip pan which holds only a minimal amount of grease. To prevent grease fires, the pan must be cleaned after each use.

⚠ DANGER: READ ALL INSTRUCTIONS CAREFULLY BEFORE OPERATING GRILL. FAILURE TO FOLLOW THESE INSTRUCTIONS EXACTLY COULD RESULT IN A FIRE CAUSING SERIOUS INJURY OR DEATH.

Pearland Floors And Design

1607 North Main St
Pearland, TX 77581 US
346.901.8094
sales@pearlandfloors.com



Carpet

INVOICE

BILL TO
Casey & Michael Higgins
6120 Southwell Lane
League City, TX 77573

INVOICE 1027
DATE 04/19/2021
TERMS Due upon completion
DUE DATE 05/14/2021

ACTIVITY	DESCRIPTION	QTY	RATE	AMOUNT
<u>Earthwerks Urban Carpet</u>	Trenton; Includes 8# pad, take up and haul away of existing carpet, tack strip, z bar, labor, stairs	1	5,900.00	5,900.00T

SUBTOTAL	5,900.00
TAX	486.75
TOTAL	6,386.75
PAYMENT	6,386.75
BALANCE DUE	\$0.00
	PAID

Signature: _____ Date: _____

KICHLER

Kichler® is a registered trademark of
The L.D. Kichler Co. All Rights Reserved.

5/6/21

ITEM #0670123

PENDANT

MODEL #34753

Français p. 11

Español p. 21

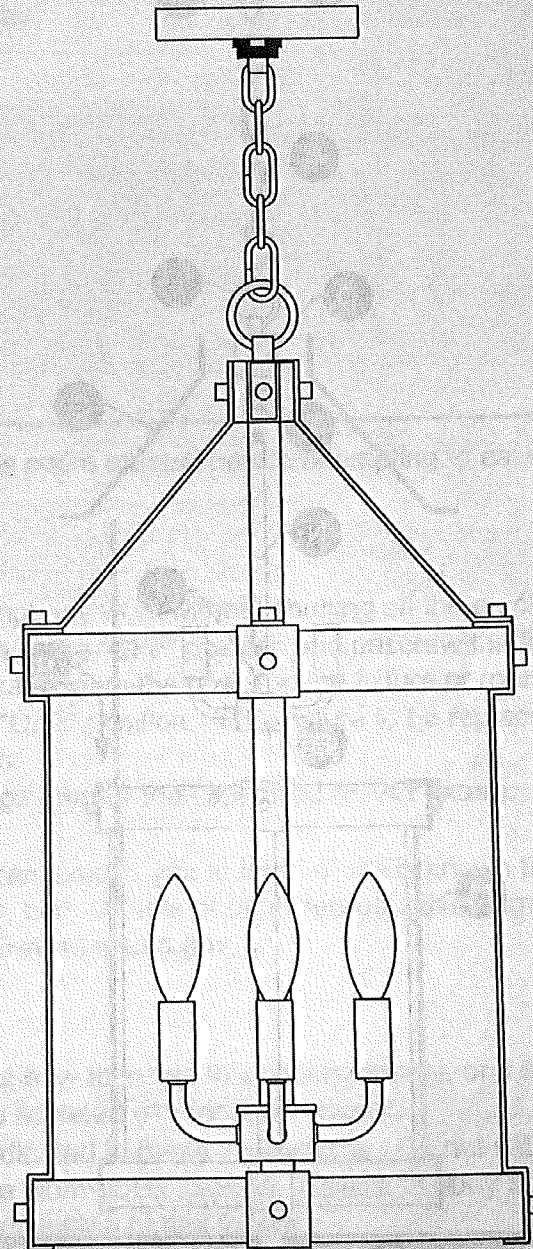

ATTACH YOUR RECEIPT HERE

Serial Number _____ Purchase Date _____



Questions, problems, missing parts? Before returning to your retailer, call our customer service department at **1-800-554-6504**, 8 a.m. - 4:30 p.m, EST, Monday - Friday.



GE APPLIANCES

Purchase
6/30/17

Installation Instructions

Built-In Dishwasher

If you have questions, call GE Appliances at 800.GE.CARES (800.432.2737) or visit our website at: GEAppliances.com. In Canada, please call 1.800.561.3344 or visit www.geappliances.ca



BEFORE YOU BEGIN

Read these instructions completely and carefully.

▲ WARNING

- To reduce the risk of electric shock, fire, or injury to persons, the installer must ensure that the dishwasher is completely enclosed at the time of installation.
- **FOR PERSONAL SAFETY:** Remove house fuse or open circuit breaker before beginning installation. Do not use an extension cord or adapter plug with this appliance.
- The improper connection of the equipment grounding conductor can result in a risk of electric shock. Check with a qualified electrician or service representative if you are in doubt that the appliance is properly grounded.
- If house wiring is not 2-wire with ground, a ground must be provided by the installer. When house wiring is aluminum, be sure to use UL-Listed anti-oxidant compound and aluminum-to-copper connectors.

▲ CAUTION

Do not remove wood base until you are ready to install the dishwasher. The dishwasher will tip over when the door is opened if base is removed.

Model #
GDT695SSJSS

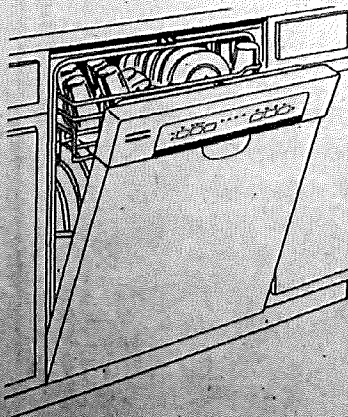

CHECK THE FOLLOWING

- Tub trim does not interfere with the door
- Dishwasher is square and level at both the top and bottom of the cabinet opening, with no twisting or distortion of the tub or door
- All 4 legs of the dishwasher are firmly in contact with the floor
- Drain hose is not pinched between the dishwasher and adjacent cabinets or walls
- Tub trim is fully seated on the tub flange

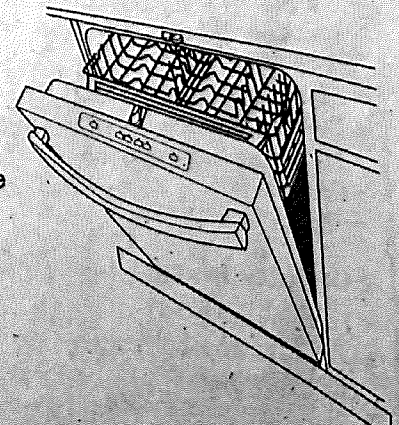

FOR YOUR SAFETY

Read and observe all **WARNINGS** and **CAUTIONS** shown throughout these instructions.

While performing installations described in this booklet, **gloves, safety glasses or goggles should be worn.**

IMPORTANT – Observe all governing codes and ordinances.

- **Note to Installer** – Be sure to leave these instructions for the consumer's and local inspector's use.
- **Note to Consumer** – Keep these instructions with your Owner's Manual for future reference.
- **Skill Level** – Installation of this dishwasher requires basic mechanical, electrical and plumbing skills. **Proper installation is the responsibility of the installer. Product failure due to improper installation is not covered under the GE Appliances Warranty. See warranty information.**
- **Completion Time** – **1 to 3 Hours.** New installations require more time than replacement installations.

IMPORTANT – The dishwasher **MUST** be installed to allow for future removal from the enclosure if service is required.

Care should be exercised when the appliance is installed or removed, to reduce the likelihood of damage to the power supply cord.

If you received a damaged dishwasher, you should immediately contact your dealer or builder.

Optional Accessories – See the Owner's Manual for available custom panel kits.

Your dishwasher is a water heating appliance.

**READ CAREFULLY
KEEP THESE INSTRUCTIONS**

31-31560-1 09-16 GEA

Installation Instructions

Over the Range Microwave Oven

Questions? Call 800.GE.CARES (800.432.2737) or Visit our Website at: ge.com

BEFORE YOU BEGIN

Read these instructions completely and carefully.

- **IMPORTANT** — Save these instructions for local inspector's use.
- **IMPORTANT** — Observe all governing codes and ordinances.
- **Note to Installer** — Be sure to leave these instructions with the Consumer.
- **Note to Consumer** — Keep these instructions for future reference.
- **Skill level** — Installation of this appliance requires basic mechanical and electrical skills.
- Proper installation is the responsibility of the installer.
- Product failure due to improper installation is not covered under the Warranty.

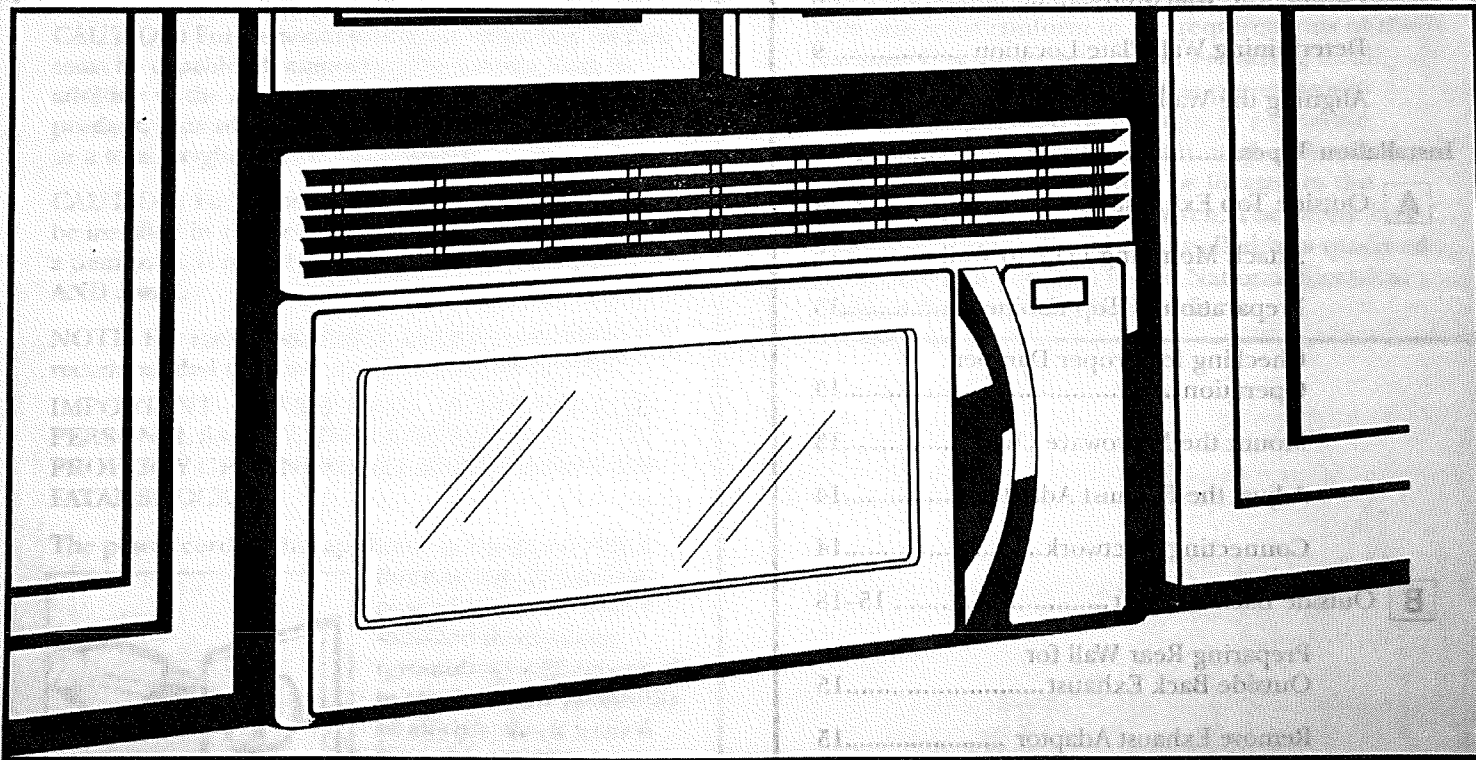

For a Spanish version of this manual, visit our Website at ge.com.

Para consultar una versión en español de este manual de instrucciones, visite nuestro sitio de internet ge.com.

**READ CAREFULLY.
KEEP THESE INSTRUCTIONS.**

Limited Lifetime & 5 Year Warranty

Cabinets

Five Year Limited Warranty on Cabinets - Aristokraft warrants to original consumer purchasers for a period of five years from the original date of purchase that all other components of Aristokraft cabinetry shall be free from defects in material and workmanship under normal use.

Lifetime Limited Warranty on Drawer Guides and Hinges - Aristokraft warrants to original consumer purchasers for as long as they own their homes that the drawer box, drawer guides and hinges used in the manufacture of Aristokraft cabinetry products shall be free from defects in material and workmanship under normal use.

These warranties are only applicable to products used in residential applications within the United States and is not transferable to subsequent owners.

Should defects in material or workmanship exist during the applicable warranty period in any Aristokraft product, Aristokraft will elect at its discretion to either repair or replace the defective material or component free of charge. This warranty covers only parts and materials of the products supplied by Aristokraft. Not covered under this warranty are counter tops, appliances, plumbing fixtures, etc. or the costs, including labor, to remove and reinstall materials and related components such as fittings, appliances, etc.

This warranty shall become void if the cabinets are in any way modified, improperly installed or damaged prior to or during the installation. This also disclaims products utilized in any application other than the standard. Furthermore, this warranty will not apply to cabinets damaged by misuse, neglect, abuse, acts of God, exposure to moisture, exposure to extreme temperatures or the effects of normal wear and tear.

Natural woods may vary in color, characteristics and exhibit subtle changes as they age. Sunlight, smoke, household cleaners and other environmental conditions may also affect the color match over time. These variations are considered to be the nature of the material in relation to their environmental exposure and are not covered under this warranty.

Aristokraft reserves the right to alter design, specifications and material without obligation to make similar changes to products previously manufactured.

The repair(s) or replacement(s) are contingent upon the current product offerings of styles and construction options within the Aristokraft product at the time of the warranty claim. If a warranty claim is filed after an Aristokraft product becomes obsolete, Aristokraft reserves the right to honor the warranty in one of the following fashions:

- 1) To replace the affected component with a new component of the same style.
- 2) To replace the affected component and any other component(s) in the residential application to achieve a uniform appearance with a similar and comparable product style of the originally purchased style.

If components are replaced, Aristokraft cannot guarantee that the finish of these replacements will exactly match the finish and appearance of the components in the residential application. This is due to the changes that occur during the woods' natural aging process, affecting its color and grain.

THIS WARRANTY IS THE EXCLUSIVE WARRANTY OF ARISTOKRAFT AND IS IN LIEU OF AND ARISTOKRAFT DISCLAIMS ALL OTHER WARRANTIES, EXPRESSED OR IMPLIED, INCLUDING THE IMPLIED WARRANTIES OF MERCHANTABILITY AND FITNESS FOR A PARTICULAR PURPOSE.

This warranty gives you specific legal rights and you may have other rights, which vary from state to state. Some states do not allow the exclusion or limitation of incidental or consequential damages, so the above limitations or exclusions may not apply to you.

To obtain replacement(s) under Aristokraft's Five Year and Lifetime Limited warranties, first contact your authorized Aristokraft Cabinetry dealer or distributor, who will arrange for inspection of the cabinet. A dated sales receipt as proof of purchase is required to obtain benefits from this warranty.

If you have difficulty obtaining assistance, please write to: Aristokraft, One MasterBrand Cabinets Drive, P.O. Box 420, Jasper, IN 47547-0420. Phone: (812) 482-2527 Fax: (812)634-2838

Aristokraft is a subsidiary of MasterBrand Cabinets, Inc.

Aristokraft
CABINETRY





P39 PRESSURE CLEANER
VVE000008
CV CA02 0107 0921 0720

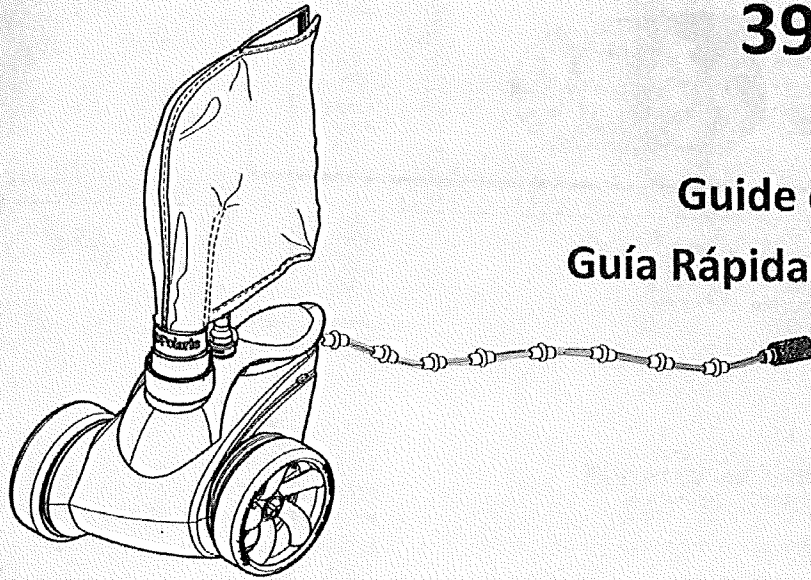

3900 Sport/P39

Quick Start Guide

Guide de Démarrage Rapide

Guía Rápida de Puesta en Marcha



CAUTION: USE OF POLARIS 3900 Sport/P39 IN A VINYL LINER POOL.

Certain vinyl liner patterns are particularly susceptible to rapid surface wear or pattern removal caused by objects coming into contact with the vinyl surface, including pool brushes, pool toys, floats, fountains, chlorine dispensers, and automatic pool cleaners. Some vinyl liner patterns can be seriously scratched or abraded simply by rubbing the surface with a pool brush. Ink from the pattern can also rub off during the installation process or when it comes into contact with objects in the pool. Zodiac Pool Systems, Inc. and its affiliates and subsidiaries are not responsible for, and the Limited Warranty does not cover, pattern removal, abrasion or markings on vinyl liners.

ATTENTION: CONCERNANT L'UTILISATION DU POLARIS 3900 Sport/P39 DANS UNE PISCINE A REVETEMENT VINYLE

La surface de certains revêtements vinyle à motifs peut s'user rapidement et les motifs peuvent disparaître au contact d'objets tels que brosses de nettoyage, jouets, bouées, fontaines, distributeurs de chlore et nettoyeur de piscine automatique. Les motifs de certains revêtements vinyle peuvent être égratignés ou usés par simple frottement, tel qu'avec une brosse de piscine. La couleur de certains motifs peut également s'effacer pendant l'installation ou en cas de contact avec des objets présents dans la piscine. Les motifs effacés, l'usure ou l'égratignure des revêtements vinyle ne relèvent pas de la responsabilité de Zodiac Pool Systems, Inc. et de ses filiales et filiales, et ne sont pas couverts par la garantie limitée.

PRECAUCIÓN: USO DEL POLARIS 3900 Sport/P39 EN UNA PISCINA REVISTIDA DE VINILO

Los dibujos en algunos revestimientos de vinilo son especialmente susceptibles a desgaste superficial o borrado del dibujo, como resultado de que entren en contacto con la superficie vinílica determinados objetos, tales como cepillos, juguetes de piscina, flotadores, fuentes, surtidores de cloro y limpiatfondos automáticos. Los dibujos de algunos revestimientos de vinilo pueden rayarse o rasgarse de manera considerable simplemente al rozar la superficie con un cepillo de piscina. También puede borrarse la tinta del dibujo durante la instalación o al entrar en contacto con objetos en la piscina. Zodiac Pool Systems, Inc. y sus filiales y subsidiarias no asume responsabilidad alguna por el borrado del dibujo o el rayado o rasgado del revestimiento de vinilo, ni la garantía limitada cubre estas contingencias.

Pro-C

Residential and Light Commercial Irrigation Controllers

PC Series

Modular Controller
Indoor/Outdoor Models

Owner's Manual and
Installation Instructions

Please leave with property owner

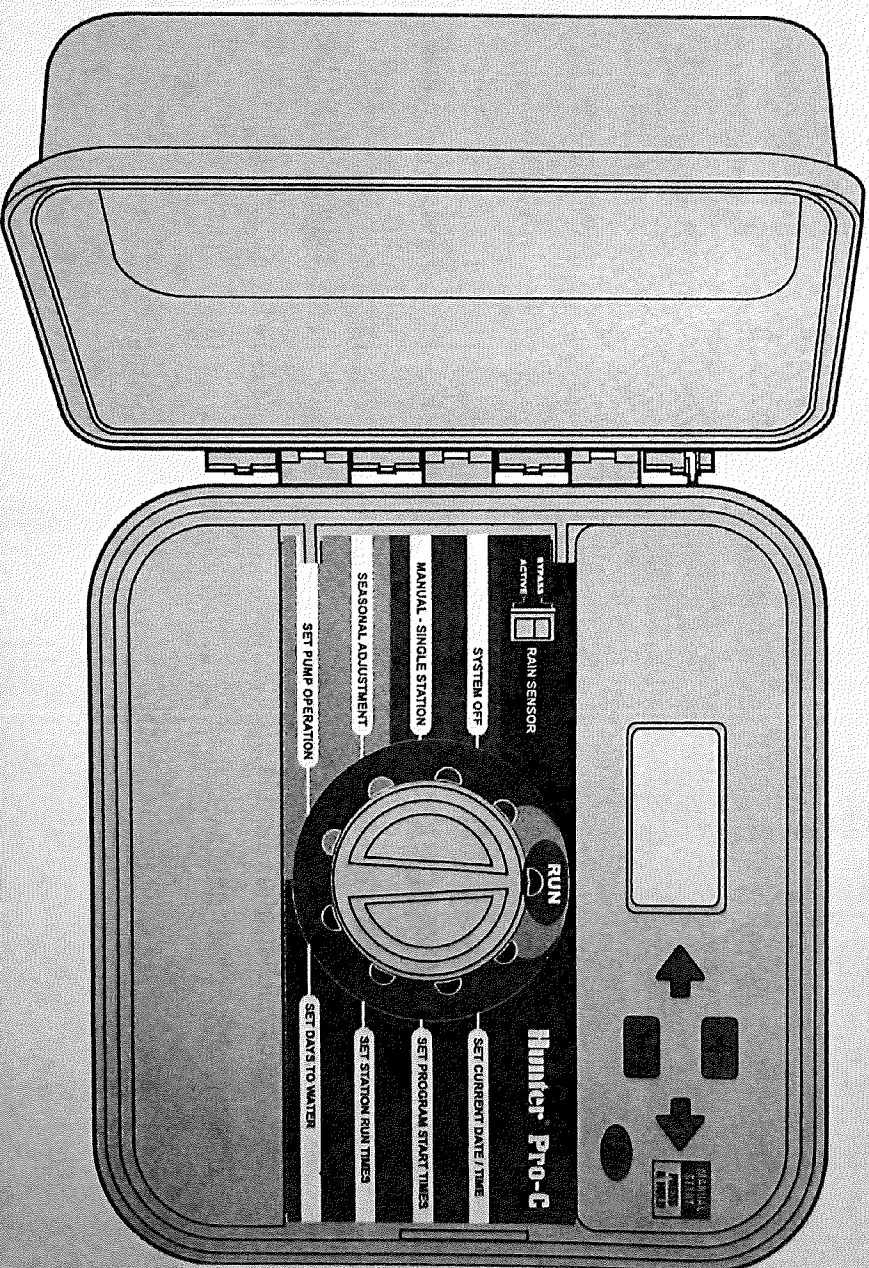

Hunter®



iCHLOR®

SALT CHLORINE GENERATOR

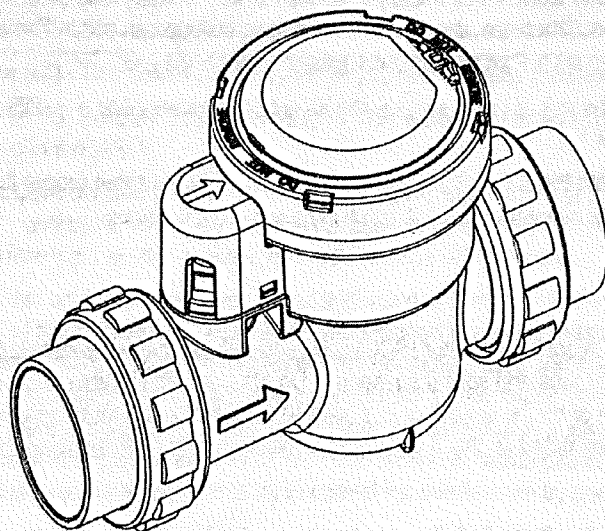

INSTALLATION AND
USER'S GUIDE

IMPORTANT SAFETY INSTRUCTIONS
READ AND FOLLOW ALL INSTRUCTIONS
SAVE THESE INSTRUCTIONS

UTILITY ELEMENT
OF BUILDING LINE

THREE TON HOODS ROCK MATERIAL
ON NOTCHED POOL BEAM

HOODS ROCK CAP ON
NOTCHED POOL BEAM

TANNING LEDGE 6' 6" DEPTH
WITH 20 POUND HOLEDGED BUILDING

TANNING LEDGE 6' 6" DEPTH

TANNING LEDGE 6' 6" DEPTH

FUTURE COVERED PATIO

COVERED PATIO

8" SWEET LIGHT EMBLEM

HIGGINS RESIDENCE

SCALE: 1/8" = 1'-0"

DETAIL: NOTCHED POOL

SECTION: BRENT LONGSOTHAM

PERMIT OFFICE: LEAGUE CITY

SECTION: 9

BLOCK: 1

LOT: 24

KEY MAP

MASTER POOLS



The Mark of Legendary Craftsmanship



Rainey Pool Company

INCORPORATED

1101 GULE FREEMAN SOUTH
LEAGUE CITY, TEXAS 77570
(281) 339-1555

The Associa
Pool & Spa Pro

6120 SOUTHWELL HOUSE DETAILS

KEYS, OPENERS, CODES

-RING DOOR BELL, FRONT DOOR, GARAGE KEY PAD, BACK DOOR

TRASH DAYS

TUES & FRI

PAINT COLORS PROVIDED ON SEPARATE SHEET
WE ARE PROVIDING THE FLOORING DETAILS IN CASE YOU MIGHT NEED.

FIREPLACE - LIGHTING IT UP

COOKTOP AND MICROWAVE VENTING

WATER SOFTNER

- MAINTENANCE IS ONCE A YEAR, REPLACE FILTERS UNDER KIT SINK, AND GARAGE UNITS
- AROUND \$230 TO MAINTENANCE
- DRAINS INTO THE WASHER DRAIN AT NIGHT AROUND 1 AM
- UNDER KITCHEN SINK FILTERS

SPRINKLER SYSTEM/WATER BILL

A/C SYSTEM

- DEHUMIDIFYING
- DRAINING IN SINKS
- WE HAVE USED WEEKS SERVICE, EVERY SPRING AND FALL WE HAVE THE SYSTEM MAINTENANCED
- IT COSTS AROUND \$200ea. TIME.
- FILTERS ARE 20X25X4, YOU NEED 2.

POOL EQUIPMENT

- WATERFALL & LIGHT
- FILTER PUMP, FILTERS & POOL VACUUM
- ADD CHLORINE
- FILING/DRAINING THE POOL

- Umbrella Holes

- WATER SHUTOFF
- UPSTAIRS CLOSET COMPONENTS
- WINDOWS OPENING

OUTDOOR SWITCHES & FANS
PATIO FINISH - POWERWASHING/SEALING

PEST CONTROL SYSTEM

WE LABELED SOME OF THE LIGHT SWITCHES TO HELP YOU ADJUST, YOU CAN TAKE OFF WHEN YOUR READY.

Pool Bays

PAINTS

ROOM	COLOR
STUDY	WORLDLY GREY SATIN
FOYER/FRONT HALL	
BUTLERS PANTRY	
FRONT BATHROOM	
FRONT SECONDARY ROOM	
KITCHEN	
BREAKFAST	
DINING	
STAIRS	
GAMEROOM	
UPSTAIRS POWDER	
MASTER BATH, CLOSETS & FLEX RM	
MASTER BEDROOM	REQUISITE GREY
GUEST ROOM & GBATH	EGGSHELL
DOWNSTAIRS POWDER	DEBONAIR SATIN
LAUNDRY	
SECONDARY BEDROOM - AQUA COLOR	TIDEWATER SATIN

AREAS NOT PAINTED - ORIGINAL HOUSE COLOR

- FOYER COAT CLOSET
- HALL LINEN CLOSET
- CLOSETS IN SECONDARY BEDROOMS
- PANTRY
- UPSTAIRS CLOSET

ACCENT WALL BLUSTERY SKY SATIN

KITCHEN ISLAND BLUSTERY SKY SATIN

House was built by Ryland
 They used Pittsburgh Paints - PPG
 Exterior Trim colors are
 -Sautted Mushroom (tan color)
 for the Body (Soffits, Doors, Shed Main)
 -Almond (cream color) for the trim
 Brick is Boral Brand, Castlebrook color

Pearland Floors And Design

1607 North Main St
Pearland, TX 77681 US
346.901.8094
sales@pearlandfloors.com



LVP -
Luxury Vinyl Plank

INVOICE

BILL TO
Casey & Michael Higgins
6120 Southwell Lane
League City, TX 77573

INVOICE 1029
DATE 04/19/2021
TERMS Due upon completion
DUE DATE 05/14/2021

ACTIVITY	DESCRIPTION	QTY	RATE	AMOUNT
Knoa LVP	Tabacco Road oak	1	0.00	0.00T
LVP Installation	Labor	1	7,055.00	7,055.00
Quarter Round - Primed White	38 pieces	456	0.72	328.32T
Quarter Round - Primed White Installation	Including Caulking	456	2.00	912.00
Floor Prep	Per Bag	22	25.00	550.00T
Floor Prep Labor	Per Bag	22	25.00	550.00
Red Oak Unfinished Baby Threshold	per LF	16	2.00	32.00T
Red Oak Unfinished Baby Threshold	per LF; Stained to blend	16	4.50	72.00
Baseboard Installation w/caulking	Per LF	120	4.00	480.00
Stair Install Labor	per step	1	216.00	216.00

SUBTOTAL	10,195.32
TAX	75.10
TOTAL	10,270.42
PAYMENT	10,270.42
BALANCE DUE	\$0.00
	PAID

Signature: _____ Date: _____