



Performance & Financial Analysis

Prepared October 28, 2016 for

Ahren Schulz

4765 County Road 747A, Brazoria, TX 77422

Phone: 713-385-8212

Email: ahren_s@hotmail.com



Prepared by Marshall Harkins

Texas Solar Outfitters, 705 Shepherd Dr, Houston, TX 77007

Phone: 713-802-0223 * Email: marshall@texassolaroutfitters.com



Executive Summary

Performance Summary

Solar Electric (PV) System: 13.096 kW DC (13.083 kW AC) producing 19,120 kWh/Year.

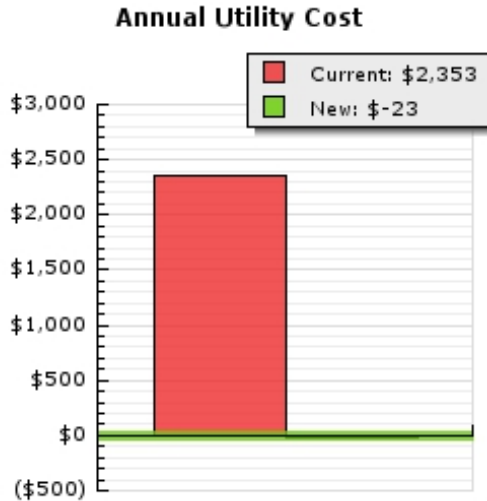

Utility Savings over System Life (25 years)

Total:	\$92,504
As Gross Income Dollars:	\$123,338

Investment Performance

Cashflow Payback:	7.6 years
Internal Rate of Return (IRR):	14.2%
Cash Gained over System Life:	\$96,170
Property Value Appreciation:	\$47,520
CO2 Saved over System Life:	392 tons

Electric Utility Savings: Anticipate a savings of approximately \$2,295 in electric bills (101%) at current utility rates in the first year. Savings will grow as electric utility rates are expected to rise 3.50% a year. The purchase of electric energy (kWh) from your utility is expected to be reduced by 101%.

Purchase Price & Net Cost

Contract Price:	\$43,812
Incentives to Customer:	(\$16,644)
Net Purchase Cost:	\$27,168

Installation Incentives:

Green Mountain Energy Solar Rebate:	\$5,000
Federal Tax Credit (30% of Net Cost at Installation):	\$11,644

Finance: Cash

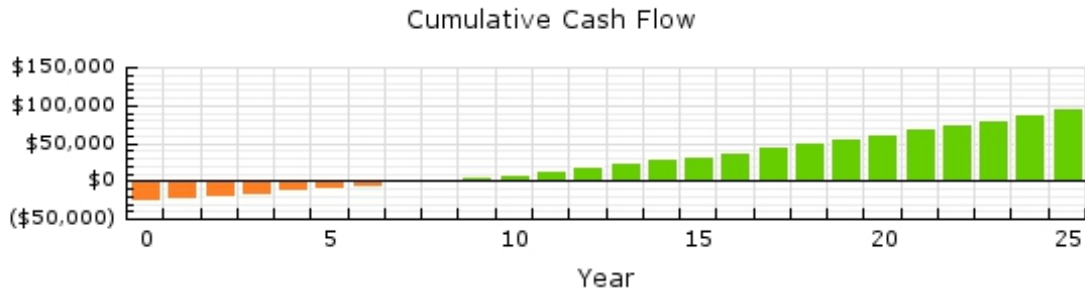



The Cost of Doing Nothing

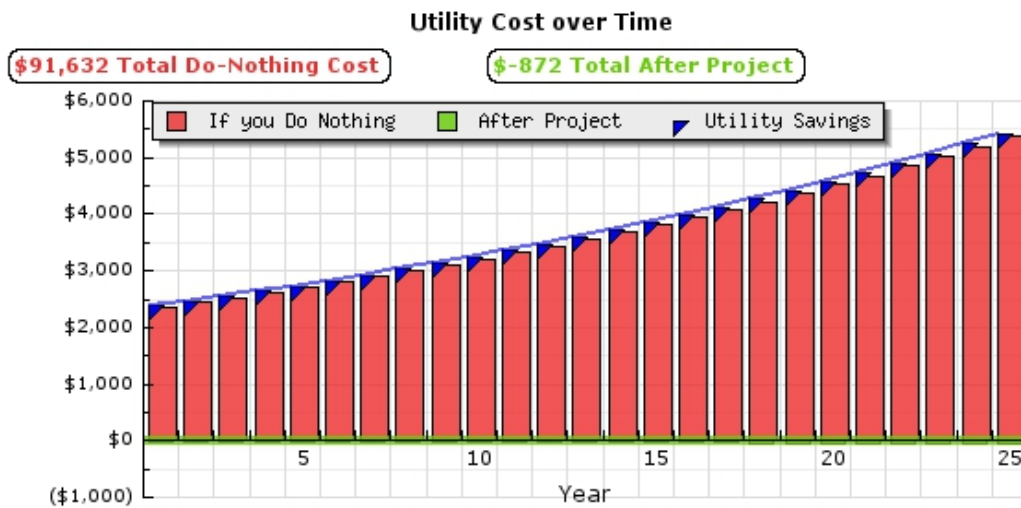

Your Hedge Against Utility Inflation: Your investment in this project will protect you from utility rate inflation.

Utility Cost by Month

Includes monthly Net-Metering "True-Up" to reconcile any net-meter credits accumulated in prior month(s).

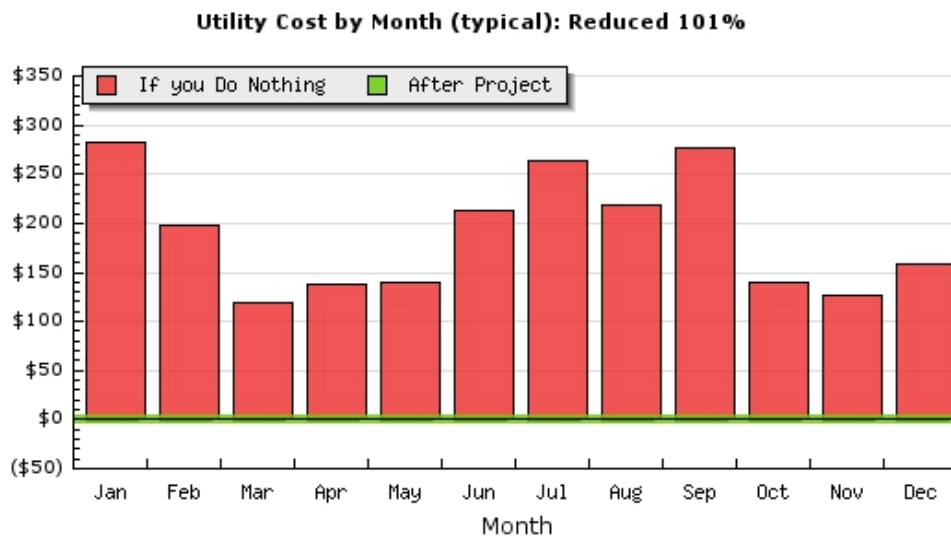



Solar Electric (PV) System Summary

Solar Electric (PV) kWh Production by Month (typical)

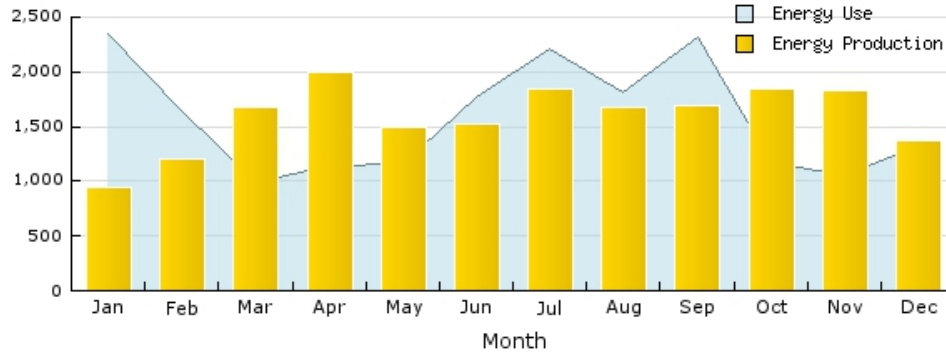

Array #1

Tilt: 45° Azimuth: 190° 3" Air Gap
Shade reduces production: 5%

PV Panels: 20 x SunPower, Model: SPR-327E-WHT-D (327.00 watts) Equinox

Inverters: 20 x SunPower, Model: SPR-E19-327-C-AC-Equinox

Included: * TX Sales Tax: \$1,965

Upgrades:

* TDI Windstorm Certification: \$1,150

Array #2

Tilt: 23° Azimuth: 190° 3" Air Gap
Shade reduces production: 5%

20 x SunPower, Model: SPR-327E-WHT-D (327.00 watts) Equinox

20 x SunPower, Model: SPR-E19-327-C-AC-Equinox

Total Panel Area: 909 sq-ft

System Peak Power: 13.096 kW DC (13.083 kW AC, 13.079 kW CEC)

Annual Production: 19,120 kWh. Supplying 101% of annual electric use

Contract Price Summary: Solar Electric (PV) System

Contract Amount: \$43,812

Incentives available to Customer in 1st Year

Green Mountain Energy Solar Rebate: (\$5,000)

Federal Tax Credit (30% of Net Cost at Installation): (\$11,644)

Net Cost at Install (after incentives): \$27,168

Carbon Footprint

Your carbon footprint will be reduced. Over the life of your system 392 tons of carbon dioxide (CO₂) will be eliminated from your footprint. Equivalent to:



Planting 9,134 trees.



Driving reduced by 784,000 auto miles, or 39,984 gallons of gasoline.



Recycling 1,239 tons of waste instead of sending it to landfill.



381,973 pounds (191.0 tons) of coal burned.



and you will help avoid the use of up to **9,559,500 gallons of water by Thermoelectric Powerplants.**



Sales & Service Contract

This Contract is made by and between Texas Solar Outfitters located at 705 Shepherd Dr, Houston, TX 77007 (Contractor) and:

Customer

Correspondence & Work Location

Ahren Schulz
4765 County Road 747A
Brazoria, TX 77422
Phone: 713-385-8212
Email: ahren_s@hotmail.com

Major Equipment to be Installed

Solar Electric (PV) System

Array #1

PV Panels: 20 x SunPower, Model: SPR-327E-WHT-D
(327.00 watts) Equinox

Inverters: 20 x SunPower, Model:
SPR-E19-327-C-AC-Equinox

Included: * TX Sales Tax: \$1,965

Upgrades:

* TDI Windstorm Certification: \$1,150

Array #2

20 x SunPower, Model: SPR-327E-WHT-D
(327.00 watts) Equinox

20 x SunPower, Model:
SPR-E19-327-C-AC-Equinox

Payment Schedule

Down Payment	\$4,000	Due at Signing
Completion of customer approved engineered design	\$19,906	
System Completion, Interconnection and Customer Handover	\$19,906	
Contract Total	\$43,812	

Terms & Conditions of Sale: As Attached

Signatures (print name below):

Customer: _____ Date: _____ Contractor: _____ Date: _____



TEXAS SOLAR OUTFITTERS

4.92 OUT OF 5.00



Based on 51 Reviews

DETAILED RATINGS

Sales Process	4.75
Quality of Advice	4.83
On Schedule	4.75
Price as Quoted	5.00
Quality of Products	4.97
Installation Quality	5.00
Professionalism	4.89
After Sales Support	4.89

OVERALL RATINGS

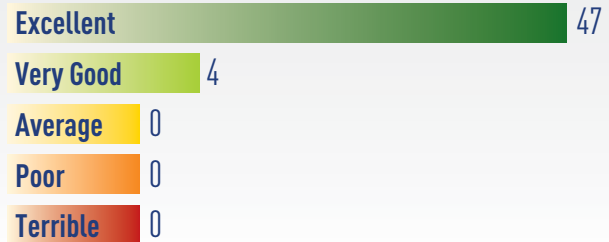

WOULD RECOMMEND



AMERICAN SOLAR ENERGY SOCIETY

Texas Solar Outfitters is a licensed Texas Electrical Contractor (#28213), and SunPower Authorized Dealer, serving customers for over 5 years from our warehouse and office facility at 705 Shepherd Dr, in the heart of Houston.

Please visit us at TexasSolarOutfitters.com. Read our reviews at SolarReviews.com.

SunPower® E-Series Residential Solar Panels | E20-327

More than 20% Efficiency

Ideal for roofs where space is at a premium or where future expansion might be needed.

High Performance

Delivers excellent performance in real-world conditions, such as high temperatures, clouds and low light.^{1,2,4}

Proven Value

Designed for residential rooftops, E-Series panels deliver the features, value and performance for any home.

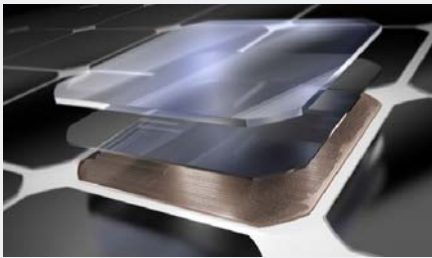

Maxeon® Solar Cells: Fundamentally better
Engineered for performance, designed for durability.

Engineered for Peace of Mind

Designed to deliver consistent, trouble-free energy over a very long lifetime.^{3,4}

Designed for Durability

The SunPower Maxeon Solar Cell is the only cell built on a solid copper foundation. Virtually impervious to the corrosion and cracking that degrade conventional panels.³

#1 Rank in Fraunhofer durability test.⁹
100% power maintained in Atlas 25+ comprehensive durability test.¹⁰

High Performance & Excellent Durability



SPR-E20-327



High Efficiency⁵

Generate more energy per square foot

E-Series residential panels convert more sunlight to electricity by producing 31% more power per panel¹ and 60% more energy per square foot over 25 years.^{1,2,3}

High Energy Production⁶

Produce more energy per rated watt

High year-one performance delivers 7–9% more energy per rated watt.² This advantage increases over time, producing 20% more energy over the first 25 years to meet your needs.³

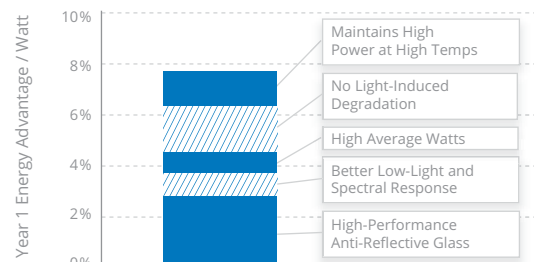
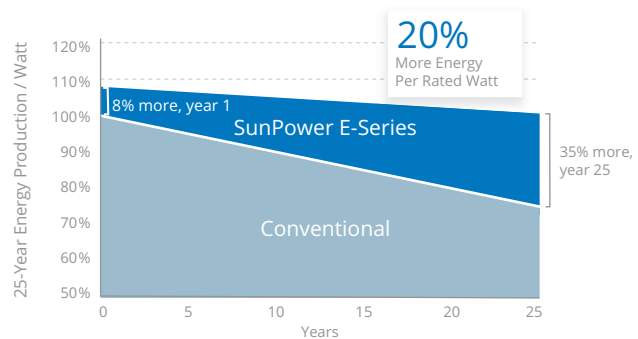

SunPower® E-Series Residential Solar Panels | E20-327

SunPower Offers The Best Combined Power And Product Warranty

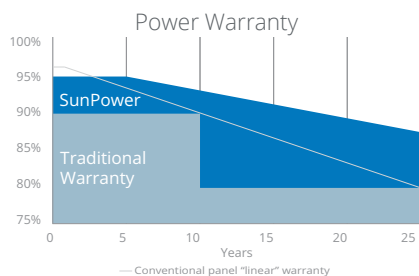

More guaranteed power: 95% for first 5 years, -0.4%/yr. to year 25⁷

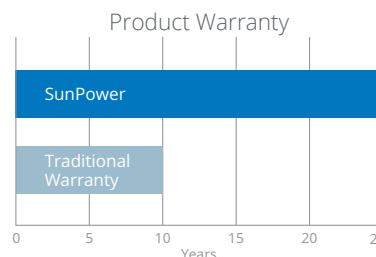

Combined Power and Product defect 25-year coverage that includes panel replacement costs⁸

Electrical Data	SPR-E20-327	SPR-E19-320
Nominal Power (P _{nom}) ¹¹	327 W	320 W
Power Tolerance	+5/-0%	+5/-0%
Avg. Panel Efficiency ¹²	20.4%	19.9%
Rated Voltage (V _{mpp})	54.7 V	54.7 V
Rated Current (I _{mpp})	5.98 A	5.86 A
Open-Circuit Voltage (V _{oc})	64.9 V	64.8 V
Short-Circuit Current (I _{sc})	6.46 A	6.24 A
Max. System Voltage	600 V UL & 1000 V IEC	
Maximum Series Fuse	15 A	
Power Temp Coef.	-0.38% / °C	
Voltage Temp Coef.	-176.6 mV / °C	
Current Temp Coef.	3.5 mA / °C	

Tests And Certifications	
Standard Tests ¹³	UL1703 (Type 2 Fire Rating), IEC 61215, IEC 61730
Quality Certs	ISO 9001:2008, ISO 14001:2004
EHS Compliance	RoHS, OHSAS 18001:2007, lead free, REACH SVHC-163, PV Cycle
Sustainability	Cradle to Cradle (eligible for LEED points) ¹⁴
Ammonia Test	IEC 62716
Desert Test	10.1109/PVSC.2013.6744437
Salt Spray Test	IEC 61701 (maximum severity)
PID Test	Potential-Induced Degradation free: 1000 V ⁹
Available Listings	UL, TUV, JET, MCS, CSA, FSEC, CEC

Operating Condition And Mechanical Data	
Temperature	-40° F to +185° F (-40° C to +85° C)
Impact Resistance	1 inch (25 mm) diameter hail at 52 mph (23 m/s)
Appearance	Class A
Solar Cells	96 Monocrystalline Maxeon Gen II
Tempered Glass	High-transmission tempered anti-reflective
Junction Box	IP-65, MC4 compatible
Weight	41 lbs (18.6 kg)
Max. Load	G5 Frame: Wind: 62 psf, 3000 Pa front & back Snow: 125 psf, 6000 Pa front
	G3 Frame: Wind: 50 psf, 2400 Pa front & back Snow: 112 psf, 5400 Pa front
	Frame

REFERENCES:

- All comparisons are SPR-E20-327 vs. a representative conventional panel: 250 W, approx. 1.6 m², 15.3% efficiency.
- Typically 7-9% more energy per watt, BEW/DNV Engineering "SunPower Yield Report," Jan 2013.
- SunPower 0.25%/yr degradation vs. 1.0%/yr conv. panel. Campeau, Z. et al. "SunPower Module Degradation Rate," SunPower white paper, Feb 2013; Jordan, Dirk "SunPower Test Report," NREL, Q1-2015.
- "SunPower Module 40-Year Useful Life" SunPower white paper, May 2015. Useful life is 99 out of 100 panels operating at more than 70% of rated power.
- Second highest, after SunPower X-Series, of over 3,200 silicon solar panels, Photon Module Survey, Feb 2014.
- 8% more energy than the average of the top 10 panel companies tested in 2012 (151 panels, 102 companies), Photon International, Feb 2013.
- Compared with the top 15 manufacturers. SunPower Warranty Review, May 2015.
- Some restrictions and exclusions may apply. See warranty for details.
- 5 of top 8 panel manufacturers tested in 2013 report, 3 additional panels in 2014. Ferrara, C., et al. "Fraunhofer PV Durability Initiative for Solar Modules: Part 2". Photovoltaics International, 2014.
- Compared with the non-stress-tested control panel. Atlas 25+ Durability test report, Feb 2013.
- Standard Test Conditions (1000 W/m² irradiance, AM 1.5, 25° C). NREL calibration Standard: SOMS current, LACCS FF and Voltage.
- Based on average of measured power values during production.
- Type 2 fire rating per UL1703:2013, Class C fire rating per UL1703:2002.
- See salesperson for details.

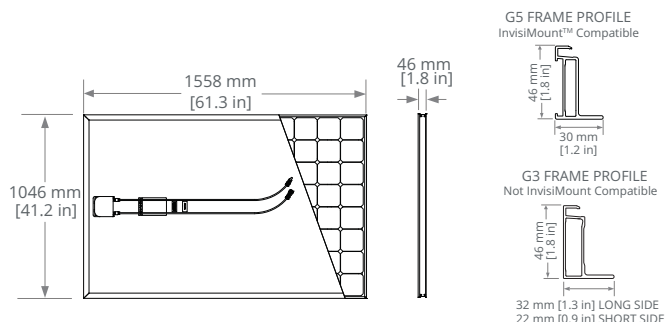

G5 frames have no mounting holes. Please read the safety and installation guide.

See www.sunpower.com/facts for more reference information.
For more details, see extended datasheet: www.sunpower.com/datasheets.

Document # 504860 Rev E /LTR_US

Introducing SunPower Equinox™



Technology designed to work together.

The SunPower Equinox™ system is the only complete home solar system that is designed and built by one company. From highest efficiency panels¹ to Smart Energy software, every component is engineered to work together perfectly—from sun to switch.

More lifetime energy without compromise.

We believe that with an integrated design process, less is more. Which is why we created SunPower Equinox to produce 70% more lifetime energy² with 70% fewer visible parts,³ for the most power without compromising curb appeal.

Best in class warranty, all from one company.

Only SunPower can offer a complete home solar system that comes with the peace of mind of one comprehensive warranty. With SunPower Equinox, we stand behind every part of your home solar experience.

1 Highest of over 3,200 silicon solar panels, Photon Module Survey, Feb 2014.
2 SunPower 345W compared to a Conventional Panel (250W, 15.3% efficient, approx. 1.6 m2), 9% more energy per watt, 0.75%/yr slower degradation. BEW/DNV Engineering "SunPower Yield Report," 2013 with CFV Solar Test Lab Report #12063, temp. coef. calculation. Campeau, Z. et al. "SunPower Module Degradation Rate," SunPower white paper, 2013. See www.sunpowercorp.com/facts for details.
3 Analysis of SunPower Equinox™ versus residential solar systems containing conventional panels, string inverters and racking hardware.

©2016 SunPower Corporation. All Rights Reserved. SUNPOWER, the SUNPOWER logo, SUNPOWER EQUINOX, ENERGYLINK, INVISIMOUNT, and MAXEON are trademarks or registered trademarks of SunPower Corporation in the U.S. and other countries.

SUNPOWER
EQUINOX™

Anatomy of a SunPower Equinox™ System

Solar Cells

Robust back-contact design for unmatched reliability

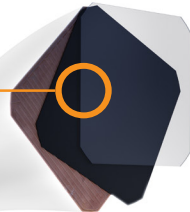

AC Panels

World-record efficiency for maximum energy production

Built-in Microinverters

Power conversion and optimization technology behind each panel

InvisiMount® Hardware

Recessed hardware designed to showcase SunPower panels

EnergyLink™ Hardware

Engineered for always-on connectivity



EnergyLink™ Software

Real-time Insights for intuitive home energy management

Technical Specifications

What's Included

- High Efficiency AC Panels with factory-integrated Microinverters
- InvisiMount Mounting Hardware
- EnergyLink Monitoring Hardware
- EnergyLink Monitoring Software

Warranty

- SunPower Panels: 25 years
- SunPower Microinverters: 25 years
- SunPower InvisiMount Hardware: 25 years
- SunPower Monitoring Hardware: 10 years

Panel Dimensions

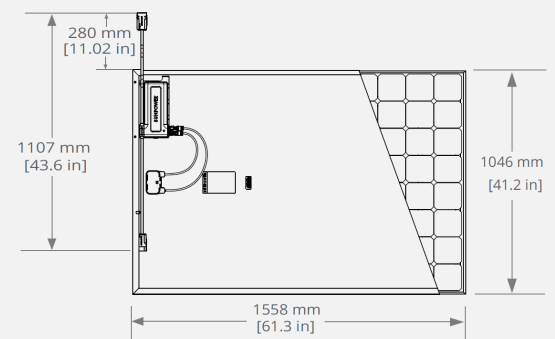

Power Options

- 20% Efficiency, 327 W
- 21% Efficiency, 335 W
- 21% Efficiency, 345 W
- 22% Efficiency, 360 W

EnergyLink Connectivity

- Hardware Ethernet
- Power Line Communication
- Wi-Fi
- Cellular Backup

Software Features

- Real-time access to solar production and home energy usage¹ any day, month, or year
- Insights including energy mix, bill savings, and environmental impact

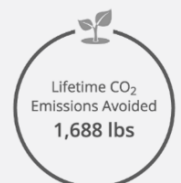
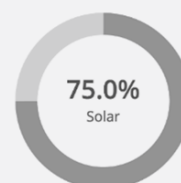
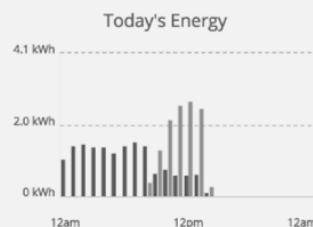

¹ Extra installation required. Please contact your SunPower dealer for details.

Terms and Conditions

Texas Solar Outfitters' ("Contractor" or "Us") business relationships with Customers ("Customer" or "You") shall be governed by our Terms and Conditions (along with the Sales and Service Contract, the "Agreement"), as defined below:

1. **Contractor's Obligations:** Contractor is providing a "turnkey" system to Customer which includes all applicable standard hardware, materials, supplies and services required to provide a fully-operational system. This "turnkey" system ("System") includes the following actions:

a. Complete all preliminary designs and engineering to meet with utility interconnect specifications, NEC code and industry common installation practices (which may change in the event on-site circumstances or characteristics require design or engineering modifications).

b. Submit engineering drawings to your electric utility company for review and pre-approvals to tie your Solar Electric Power system to the power grid (which may change in the event on-site circumstances or characteristics require design or engineering modifications).

c. Secure all local authority permits and certifications as required.

d. Provide all necessary safety equipment to complete project safely and on time.

e. Supply and deliver all components and equipment as contracted. However, in the event Contractor is unable to procure the specific items comprising the System as contracted, Contractor shall have the right to substitute substantially similar items produced by a different manufacturer or offered by a different supplier in their place.

f. Install solar panels on selected roof surface according to pre-designed racking system (which may change in the event on-site circumstances or characteristics require design or engineering modifications) and secure them to meet wind loads for jurisdiction.

g. Install wiring to solar modules, inverters, combiner box, AC/DC disconnect(s) as required, and to the main breaker panel, or via a line-side tap in compliance with NEC code and utility requirements.

h. Complete system quality check, testing and Customer training.

i. Provide Customer with component warranty information and required system documentation.

j. Upon completion ("Installation Completion Date"), provide the necessary invoices and documentation to apply for possible tax credits.

k. Assign all related manufacturer's and/or supplier's warranties to you.

2. **Materials:** All materials shall be new, in compliance with all applicable laws and codes, and shall be covered by a manufacturer's warranty where appropriate.

3. **License Status and Insurance:** If required by law, all work shall be performed by individuals duly licensed and authorized to perform said work. Further, Contractor shall maintain insurance general liability and workers' compensation insurance at all times during the installation of the System.

4. **Permits and Approvals:** Contractor shall obtain all permits necessary for the work to be performed and completed. The System shall not be turned over to Customer until all permits are final and not subject to approval. If Contractor is unable to obtain a structural stamp or city/historic district approval for the System, the Contractor may terminate the Agreement, refund any money paid to Contractor and have no further liability or obligation to Customer.

5. **Passing of Title:** Title to all equipment (“Equipment”) provided by or through us as part of the System shall pass to you immediately upon our delivery of the Equipment to the property upon which the System will be placed. Thereafter, you shall bear all risk of loss with respect to the System and shall insure the System at your cost and expense.

6. **Customer’s Representations:** Customer represents that (a) it either owns or leases the property upon which the System will be placed (“Property”) and if it leases has received all necessary approvals from the lessor for the installation of the System; (b) Customer has full power and authority to execute this Agreement and to perform its obligations hereunder; and (c) the execution and delivery of this Agreement has been authorized by all necessary action, and the person signing for Customer has authority to enter into this Agreement on its behalf and bind Customer to this Agreement.

7. **Information and Services:** Promptly following the execution of an agreement with Contractor, Customer shall furnish or cause to be furnished (i) all reports, surveys, drawings and tests concerning the conditions of the Property that are in the possession or control of Customer, if the System is part of the original construction of the structure in question and (ii) information regarding Customer’s utilization of and demand for electricity at the Property, which information Customer shall request from its utility provider and which information the Contractor shall be entitled to rely upon. Customer shall provide or cause to be provided a broadband connection for communication with the monitoring system such that the Equipment can be monitored remotely.

8. **Payment and Taxes:** Customer shall pay to Contractor, as full consideration for the full and complete performance of all requirements under this Agreement, including, without limitation, performance of the services, the final project cost, which amount shall be paid as set forth in the Agreement between the parties. Customer shall pay all taxes, fees, levies and other government charges of any kind arising in connection with the project, the services or any Equipment supplied hereunder. However, Contractor shall be responsible for and shall pay (or cause to be paid) all taxes imposed upon its income and all payroll taxes of Contractor employees. Without limiting Contractor’s other remedies hereunder or at law (including, but not limited to, Contractor pursuing any deficiency from Customer), in the event Customer terminates this Agreement prior to Contractor completing the installation of the System and Customer paying for it in full, Contractor retains the right to retain some or all of any deposit paid to Contractor in order to compensate Contractor for services performed or materials purchased in connection with the System.

9. **Insurance and Indemnity:**

a. **Customer Coverage:** Customer shall obtain and maintain Property insurance for the full value of the structure upon which the Equipment will be placed through final completion of the project.

b. **Indemnification:** Customer shall fully indemnify, defend and hold harmless Contractor and its present and future direct and indirect parents, subsidiaries and affiliates, their officers, directors, shareholders, employees, representatives and agents from and against any and all claims, actions, costs, damages, judgments, suits, demands, losses and liabilities, arising from (a) any claim by Customer or a third party for physical injury or physical damage to or physical destruction of property that is not caused by Contractor’s or it’s subcontractor’s negligence, and (b) claims resulting from Customer’s breaches of this Agreement.

10. **Contractor’s Warranty:** Contractor warrants, for a period of one (1) year from the Installation Completion Date, that (i) the System (exclusive of the Equipment) shall have been designed, engineered and installed in a good and workmanlike manner, (ii) the work performed pursuant to this Agreement shall have been performed in a good and workmanlike manner, and (iii) the work performed pursuant to this Agreement shall be free from defects in workmanship.

11. **Remedy for Nonconformance with Contractor Warranty:** If Customer discovers a breach by Contractor of any of the warranties set forth in Section 10 above, then Customer shall give Contractor notice of the nonconformity with reasonable promptness following Customer’s discovery thereof (but no later than sixty (60) days after such discovery) and in no event later than the expiration of the warranty period. If Customer fails to give notice after such discovery and in no event later than the expiration of the warranty period, any claims arising out of

or related to the alleged defect are waived. Upon receipt of such notice, Contractor shall repair or replace, or cause the repair or replacement of, the nonconformity at Contractor's sole expense and discretion.

12. **Third Party Warranties:** Contractor will cause all equipment manufacturers' warranties to inure directly to the Customer. In the event of any defective Equipment, Customer shall look exclusively to the manufacturers' warranties for coverage with respect to cost of replacement parts and materials and cost of labor.

13. **Limited Warranty:** **THE WARRANTY SET FORTH IN SECTION 10 ABOVE IS EXCLUSIVE AND IN LIEU OF ALL WARRANTIES OF CONTRACTOR, EXPRESSED OR IMPLIED, OF PERFORMANCE, MERCHANTABILITY, FITNESS FOR A PARTICULAR PURPOSE, CUSTOM, USAGE OR OTHERWISE AND ANY SUCH OTHER WARRANTIES ARE HEREBY DISCLAIMED. THERE ARE NO OTHER WARRANTIES OF CONTRACTOR THAT EXTEND BEYOND THOSE SET FORTH IN SECTION 10 ABOVE WITH RESPECT TO THE SYSTEM OR THE SERVICES. NO OTHER WARRANTY, ORAL OR WRITTEN WHICH MIGHT HAVE BEEN GIVEN BY AN EMPLOYEE, AGENT OR REPRESENTATIVE OF CONTRACTOR, IS AUTHORIZED BY CONTRACTOR.**

14. **Exclusions from Contractor Warranty:** **CONTRACTOR IS NOT AND SHALL NOT BE HELD LIABLE FOR ANY NONCONFORMITY WITH THE WARRANTY GIVEN IN SECTION 10 ABOVE IF SUCH NONCONFORMITY IS DUE TO: (A) ORDINARY WEAR AND TEAR; (B) ACTS OR OMISSIONS OF CUSTOMER OR ANY CONTRACTOR OF CUSTOMER (OTHER THAN CONTRACTOR OR ITS CONTRACTORS, SUBCONTRACTORS OR VENDORS); (C) ALTERATIONS OR REPAIRS OF THE SYSTEM CARRIED OUT BY ANY PERSON OTHER THAN CONTRACTOR OR ITS CONTRACTORS, SUBCONTRACTORS OR VENDORS AUTHORIZED IN WRITING BY CONTRACTOR; (D) NEGLIGENT ACTS OF PERSONS (OTHER THAN CONTRACTOR OR ITS CONTRACTORS, SUBCONTRACTORS OR VENDORS); OR (E) A FORCE MAJEURE EVENT.**

15. **Waiver of Damages and Limitation of Liability:** **NOTWITHSTANDING ANY PROVISION IN THIS AGREEMENT TO THE CONTRARY, NEITHER CONTRACTOR NOR ANY OF ITS OFFICERS, DIRECTORS, SHAREHOLDERS, PARTNERS, AGENTS, SUBCONTRACTORS, VENDORS OR EMPLOYEES SHALL BE LIABLE HEREUNDER FOR ANY CONSEQUENTIAL OR INDIRECT LOSS OR DAMAGE ARISING OUT OF THIS AGREEMENT, WHETHER SUCH LOSS OR DAMAGE ARISES IN CONTRACT, TORT (INCLUDING NEGLIGENCE), STRICT LIABILITY, WARRANTY, STATUTE OR OTHERWISE, INCLUDING, WITHOUT LIMITATION, LOSS OF REVENUES, LOSS OF PROFIT, COST OF CAPITAL, LOSS OF GOODWILL, INCREASED OPERATING COSTS OR ANY OTHER SPECIAL OR INCIDENTAL DAMAGES. THIS SECTION SHALL SURVIVE THE INSTALLATION COMPLETION DATE OR EARLIER TERMINATION OF THIS AGREEMENT. UNDER NO EVENT WILL CONTRACTOR'S AGGREGATE LIABILITY UNDER THIS AGREEMENT EXCEED THE AMOUNT OF PAYMENTS PAID BY CUSTOMER UNDER THIS AGREEMENT.**

16. **Survival:** Sections 8-11, 13-15 and 24 shall survive the Installation Completion Date or earlier termination of this Agreement.

17. **Force Majeure:** Contractor shall not be liable for any delay due to any event or circumstance which is unforeseeable, or being unforeseeable, unavoidable and outside of the control of Contractor, and that prevents us from performing our obligations under this Agreement, which event or circumstance (i) is not within the reasonable control, or is not the result of the gross negligence or willful misconduct, of Contractor, and (ii) shall be deemed to include, but not be limited to, acts of God, acts of civil or military authorities, acts of war or public enemy, acts of any court, regulatory agency or administrative body having jurisdiction, insurrections, riots, strikes or other labor disturbances of a general nature, breakdown of or accidents to plant equipment or facilities, fires, explosions, interruption of transportation, embargoed or other causes of a similar nature, weather delays, including, without limitation, the elements, such a heavy rains, hurricanes, tornadoes, or ice or snow storms, explosion, flood, landslide, mudslide, fire, lightning, earthquake, droughts, or volcanic action, naturally occurring epidemic or disaster, explosion or any cataclysmic occurrence. Contractor shall be entitled to a reasonable extension of time for delays due to Force Majeure; provided that any Force Majeure event that prevents performance, or is reasonably expected to prevent performance. In the event of strikes, lockouts, Force Majeure, delayed shipments by suppliers

or subcontractors or other causes hindering punctual completion for reasons that Contractor are not accountable for, Contractor shall be entitled to extend the completion date(s) by a reasonable amount of time.

18. **Final Agreement; No Waiver:** This Agreement constitutes the full and final understanding between the parties and supersedes all prior negotiations, representations and agreements. This Agreement and any attachments take precedence over Customer's additional or different terms and conditions, to which notice of objection is hereby given. Neither Contractor's commencement of performance nor delivery shall be deemed or construed as acceptance of Customer's additional or different terms and conditions. This Agreement may be amended, modified and/or terminated only by written instrument signed by both Customer and Contractor. In the event of conflict between this Agreement and any other documents incorporated into this Agreement, the terms and provisions of this Agreement shall control. The failure of either party to insist on the strict performance of any term of this Agreement shall not be deemed a waiver of that party's right to subsequently enforce such term in the event of a continuing or subsequent default by the other party. Provisions of this Agreement may only be waived by a party in writing.

19. **Independent Contractor:** Contractor shall perform and execute the provisions of this Agreement as an independent contractor, and none of Contractor, its contractors, subcontractors and other vendors, or any of their respective employees or agents shall be deemed for any purpose to be an agent, servant, employee or representative of Customer. Customer acknowledges that: (i) Contractor is an independent contractor and not an affiliate or agent of Customer's utility provider; and (ii) Contractor does not represent the Customer's utility provider in any capacity.

20. **TDLR Notice.** Contractor's services are regulated by The Texas Department of Licensing and Regulation, P. O. Box 12157, Austin, Texas 78711, 1-800-803-9202, 512-463-6599; website: www.tdlr.texas.gov/complaints.

21. **Time of Essence:** Time is expressly agreed to be of the essence of the Agreement and each, every and all of the terms, conditions and provisions herein.

22. **Invalidity:** The invalidity or unenforceability, in whole or in part, of any portion or provision of this Agreement shall not affect the validity and enforceability of any other portion or provision hereof. Any invalid or unenforceable portion or provision shall be deemed severed from this Agreement and the balance of this Agreement shall be construed and enforced as if this Agreement did not contain such invalid or unenforceable portion or provision.

23. **Drafting Ambiguities:** In interpreting any provision of this Agreement, no weight shall be given to, nor shall any construction or interpretation be influenced by the fact that counsel for one of the parties drafted this Agreement, each party recognizing that it and its counsel have had an opportunity to review this Agreement and have contributed to the final form of this Agreement.

24. **No Personal Liability:** Notwithstanding any provision in this Agreement to the contrary, it is specifically understood and agreed that there shall be absolutely no personal liability on the part of any of the officers, directors, shareholders, members, partners, agents, or employees of the parties for the payment of any amounts due hereunder, or the performance of any obligations hereunder.

25. **Assignment:** This Agreement may not be assigned by Customer without the express written consent of Contractor, which consent shall not be unreasonably withheld or delayed so long as Customer is not in default.