

AMENDMENT TO CLARIFY THE DECLARATIONS OF COVENANTS, CONDITIONS AND RESTRICTIONS FOR BENTWATER

STATE OF TEXAS §
COUNTY OF MONTGOMERY §

WHEREAS, Bentwater on the North Shore, Ltd., ("Declarant"), a Texas limited partnership, executed certain Declarations of Covenants, Conditions and Restrictions Bentwater (hereinafter referred to collectively as the "Declarations") for multiple sections more particularly defined on the attached Exhibit "A", all of which were filed of record in the Official Public Records of Montgomery County, Texas; and

WHEREAS, pursuant to the terms of the Declarations, the Declarant reserved the unilateral right prior to the Transfer Date to amend the Declarations for the purpose of correcting any typographical or grammatical error, oversight, ambiguity or inconsistency appearing therein; and

WHEREAS, the Declarant seeks to correct various oversights, ambiguities and/or inconsistencies; and

WHEREAS, the Transfer Date has not yet occurred; and

WHEREAS, reference is hereby made to the Declarations for all purposes, and any and all capitalized terms used herein shall have the meanings set forth in the Declarations, unless otherwise specified in this Amendment to Clarify the Declarations of Covenants, Conditions and Restrictions For Bentwater (the "Amendment to Clarify"); and

WHEREAS, some of the Declarations use the defined term of "Control Transfer Date" and some of the Declarations use the defined term of "Transfer Date" (such terms each having the same meaning); for purposes of this Amendment to Clarify, the term "Transfer Date" will collectively refer to both of the foregoing defined terms.

NOW THEREFORE, in consideration of these premises, Declarant hereby clarifies the following provisions in the Declarations:

Architectural Control Committee Election:

There is and there shall be only one (1) Architectural Control Committee for the entirety of Bentwater. In accordance with the Declarations regarding the Transfer Date, the Members by vote in accordance with the governing documents, shall elect a committee of 3 members to be known as the Bentwater Architectural Control Committee. From and after the Transfer Date, each member of the Architectural Control Committee must be a Member of the Association.

**Vehicles Permitted to Use Private Roads:**

*The use of the word "vehicle" in this provision means a motorized vehicle. This provision is not intended to prohibit the use of (by way of example and not limitation) bicycles, skateboards or non-motorized scooters.*

**Signs, Advertisements and Billboards:**

*Upon the occurrence of the Transfer Date, the prior written approval of the Committee is required for the installation of street or directional signs within the Subdivision. Upon the occurrence of the Transfer Date, the prior written approval of the Declarant will no longer be required for the installation of street or directional signs within the Subdivision.*

**Amendments:**

*In addition to the amendment rights set forth in the Declarations, the Board of Trustees, by unanimous consent, shall have the right, without the joinder or consent of any Owner or other party, to amend any or all of the Declarations (as applicable) by an instrument filed of record in the Official Public Records of Montgomery County, Texas, for the purpose of correcting any typographical or grammatical error, oversight, ambiguity or inconsistency appearing therein, provided that any such amendment shall be consistent with and in furtherance of the general plan and scheme of development as evidenced by the Declarations and shall not impair or adversely affect the vested priority or other rights of any Owner or his or her mortgage.*

The foregoing clarifications are hereby incorporated into the Declarations as if the same had been made a part thereof as originally recorded.

Upon the occurrence of the Transfer Date, this Amendment to Clarify may be amended by the Board of Trustees pursuant to the provision contained hereinabove. Additionally, upon the occurrence of the Transfer Date, the Members may also amend this Amendment to Clarify by not less than 2/3 of the votes allocated to the Members of the Association.

If any provision of this Amendment to Clarify is found to be in conflict with the Declarations, as amended, this Amendment to Clarify shall control.

The Declarations, as hereby clarified, are in all respects ratified and confirmed and shall remain in full force and effect.

[SIGNATURE PAGE FOLLOWS]

EXECUTED this the 4<sup>th</sup> day of May, 2017.

**DECLARANT:**

**BENTWATER ON THE NORTH SHORE,  
LTD.,** a Texas limited partnership

By: J.B. Land Co., General Partner

By: J.B. – G.P., L.L.C., General Partner

By: *Chad Mill*  
Print Name: Chad Mahlmann  
Manager

THE STATE OF TEXAS                   §  
  §  
COUNTY OF Montgomery       §

Before me, the undersigned authority, on this day personally appeared Chad Mahlmann as Manager of J.B. – G.P., L.L.C., as sole General Partner of J.B. Land Co., Ltd., a Texas limited partnership, as sole General Partner of Bentwater on the North Shore, Ltd., on behalf of said limited partnership, known by me to be the person whose name is subscribed to this instrument, and acknowledged to me that he executed the same for the purposes herein expressed and in the capacity herein expressed.

GIVEN under my hand and seal of office, this 4<sup>th</sup> day of May, 2017.

*Toni Steck*  
Notary Public – State of Texas

After Recording Return To:  
Marc D. Markel  
Lisa L. Gambrell  
Roberts Markel Weinberg Butler Hailey PC  
2277 Plaza Drive, Suite 290  
Sugar Land, Texas 77479

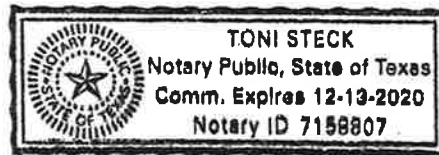

SECOND AMENDMENT TO CLARIFY THE DECLARATIONS OF  
COVENANTS, CONDITIONS AND RESTRICTIONS FOR BENTWATER

STATE OF TEXAS                   §  
  §  
COUNTY OF MONTGOMERY       §

WHEREAS, Bentwater on the North Shore, Ltd., ("Declarant"), a Texas Limited Partnership, executed certain Declarations of Covenants, Conditions and Restrictions Bentwater (hereinafter referred to collectively as the "Declarations") for multiple sections more particularly described on the attached Exhibit "A", all of which were filed for record in the Official Public Records of Real Property of Montgomery County, Texas; and

WHEREAS, pursuant to the terms of the Declarations, the Declarant reserved the unilateral right to amend the Declarations for the purpose of correcting any typographical or grammatical error, oversight, ambiguity, or inconsistency appearing therein; and

WHEREAS, there is a potential ambiguity, regarding the obligation that each Owner of a Lot maintain a Social Membership, as same is defined in the Declarations, for each Lot; and

WHEREAS, the Declarations intend for each Lot Owner to have a Social Membership, and the Declarant seeks to make a minor clarification to prevent future misinterpretation ;and

WHEREAS, reference is hereby made to the Declarations for all purposes, and any and all capitalized terms used herein shall have the meanings set forth in the Declarations, unless otherwise specified in this Second Amendment to Clarify the Declarations of Covenants, Conditions and Restrictions For Bentwater (the "Second Amendment to Clarify").

NOW THEREFORE, in consideration of these premises, the Declarant hereby amends the Declarations as follows:

The following amendment is hereby incorporated as the Final Article to the Declarations as if the same had been made a part thereof as originally recorded:

Final Article "Additional Provision" shall be inserted as follows:

Social Membership. Notwithstanding anything contained in the Declarations to the contrary, a Social Membership, as previously defined, shall be required to be maintained on each and every Lot, and the Owner of multiple Lots shall be obligated to maintain a Social Membership on each and every Lot owned.

By way of illustration and not limitation:

- (1) If an Owner of two or more adjacent Lots consolidates those adjacent Lots (pursuant to the Lot Consolidation procedure established by the Association), with the prior approval of the Bentwater Property Owners Association, Inc. and the Bentwater Architectural Control Committee, to create one building site, such consolidated building site shall be obligated to maintain one single Social Membership. If the consolidation of the adjacent Lots is terminated, each and

every Lot that made up the consolidated building site shall once again become obligated to maintain one Social Membership per Lot.

- (2) If an Owner owns two or more Lots, whether adjacent or not, that have not been consolidated into one building site, that Owner must maintain a Social Membership on each and every Lot owned.

If any provision of this Second Amendment to Clarify is found to be in conflict with the Declarations, as amended, this Second Amendment to Clarify shall control.

The Declarations, as hereby amended, are in all respects ratified and confirmed and shall remain in full force and effect.

SIGNED this the 31st day of August, 2005.

DECLARANT:

BENTWATER ON THE NORTH SHORE, LTD., A Texas limited partnership

By: J.B. Land Co., Ltd., General Partner  
By: J.B.-G.P., L.L.C., General Partner

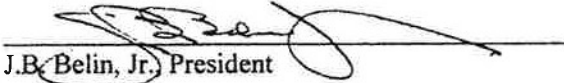
  
J.B. Belin, Jr., President

STATE OF TEXAS       §  
                                  §  
COUNTY OF HARRIS   §

BEFORE ME, the undersigned authority, on this day personally appeared J.B. Belin, Jr., the President of J.B.-G.P., L.L.C., General Partner of BENTWATER ON THE NORTH SHORE, LTD., A Texas limited partnership known to me to be the person whose name is subscribed to the foregoing instrument, and acknowledged to me that he executed the same for the purpose and consideration therein expressed, in the capacity therein stated and as the act and deed of said corporation.

SIGNED this the 31st day of August, 2005.

  
Notary Public - State of Texas

After Recording Return To:

Please return to:  
Bentwater O.T.N.S., Ltd.  
17210 West FM 1097  
Montgomery, Texas 77356



2000-097723

800-00-2810

3  
500

AMENDMENT TO CLARIFY THE DECLARATIONS OF  
COVENANTS, CONDITIONS AND RESTRICTIONS FOR BENTWATER

STATE OF TEXAS           §  
                                  §  
COUNTY OF MONTGOMERY §

WHEREAS, Bentwater on the North Shore, Ltd., ("Declarant"), a Texas Limited Partnership, executed certain Declarations of Covenants, Conditions and Restrictions Bentwater (hereinafter referred to collectively as the "Declarations") for multiple sections more particularly defined on the attached Exhibit "A", all of which were filed for record in the Official Public Records of Real Property of Montgomery County, Texas; and

WHEREAS, pursuant to the terms of Article XI of the Declarations, the Declarant reserved the unilateral right to amend the Declarations for the purpose of correcting any typographical or grammatical error, oversight, ambiguity, or inconsistency appearing therein; and

WHEREAS, due to an oversight, ambiguity, or inconsistency Article XI of the Declarations does not provide a method for amendment of the Declarations after the Declarant no longer owns Lots in a section but prior to the Control Transfer Date, as same is defined in the By-Laws of the Bentwater Property Owners Association, Inc., (the "By-Laws"); and

WHEREAS, the Declarant seeks to correct this oversight, ambiguity, or inconsistency; and

WHEREAS, the Control Transfer Date has not yet occurred; and

WHEREAS, reference is hereby made to the Declarations for all purposes, and any and all capitalized terms used herein shall have the meanings set forth in the Declarations, unless otherwise specified in this Amendment to Clarify the Declarations of Covenants, Conditions and Restrictions For Bentwater (the "Amendment to Clarify"); and

NOW THEREFORE, in consideration of these premises, Declarant hereby amends the Declarations as follows:

The following amendment is hereby incorporated into the Declarations as if the same had been made a part thereof as originally recorded.

Article XI "General Provisions," Section 11.02 shall be deleted in its entirety and replaced with the following:

Section 11.02 - Amendments. This Declaration may be amended or changed, in whole or in part, at any time by the written agreement or signed ballot of Owners (including the Declarant) of not less than two-thirds (2/3<sup>rd</sup>) of the Lots in the Subdivision. If the Declaration is amended by a written instrument signed

return to:  
Water O.T.N.S., Ltd.  
West FM 1097

800-00-2811

by those Owners of not less than two-thirds ( $2/3^{\text{rd}}$ ) of all of the Lots in the Subdivision, such amendment must be approved by said Owners within three hundred sixty-five (365) days of the date the first Owner executes such amendment. The date an Owner's signature is acknowledged shall constitute prima facie evidence of the date of execution of said amendment by such Owners. In the case that an amendment is approved by Owners by the use of written ballots, which are not notarized, then any such amendment shall become effective when the joinder and consent of Declarant is appended thereto, and when the instrument is filed for record in the Real Property Records of Montgomery County, Texas, accompanied by a certificate, signed by the President or Vice President and Secretary, stating that the required number of Owners executed the instrument amending this Declaration or signed a ballot. Copies of the written ballots pertaining to such amendment shall be retained by the Association for a period of not less than three (3) years after the date of filing of the amendment or termination.

Those Owners representing not less than two-thirds ( $2/3^{\text{rd}}$ ) of all of the Lots may also vote to amend this Declaration, in person or by proxy, at a meeting of the Owners of property in this Subdivision duly called for such purpose, written notice of which shall be given to all Owners at least ten (10) days and not more than sixty (60) days in advance and shall set forth the purpose of such meeting. Notwithstanding any provision contained in the By-Laws to the contrary, a quorum, for purposes of such meeting, shall consist of not less than seventy percent (70%) of all of the Owners (in person or by proxy) entitled to vote. Any such amendment shall become effective when the joinder and consent of Declarant is appended thereto, and when the instrument is filed for record in the Real Property Records of Montgomery County, Texas, accompanied by a certificate, signed by the President or Vice President and Secretary, stating that the required number of Owners executed the instrument amending this Declaration or cast a written vote, in person or by proxy, in favor of said amendment at the meeting called for such purpose. Copies of the written ballots pertaining to such amendment shall be retained by the Association for a period of not less than three (3) years after the date of filing of the amendment or termination.

After the Control Transfer Date, in addition to the requirements set out in this Section 11.02, consent and joinder by the Bentwater Property Owners Association, Inc., (as evidenced by the President's or Vice President's signature) in lieu of the Declarant shall be required to amend or modify this Declaration.

In granting or withholding its consent, the Declarant and subsequently the Bentwater Property Owners Association, Inc., shall consider the following factors, by way of illustration and not limitation: the overall general plan and scheme of development; promotion and enhancement of the desirability and

800-00-2812

attractiveness of the Lots, the Subdivision, and Bentwater; and/or preservation of property values.

If any provision of this Amendment to Clarify is found to be in conflict with the Declarations, as amended, this Amendment to Clarify shall control.

The Declarations, as hereby amended, are in all respects ratified and confirmed and shall remain in full force and effect.

SIGNED this the 27th day of October, 2000.

DECLARANT:

BENTWATER ON THE NORTH SHORE, LTD.,  
A Texas limited partnership

By: J.B. Land Co., Ltd., General Partner  
By: J.B.-G.P., L.L.C., General Partner

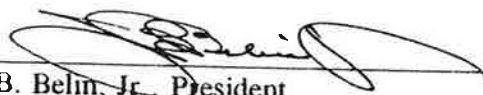
  
\_\_\_\_\_  
J.B. Belin, Jr., President

STATE OF TEXAS       §  
                                  §  
COUNTY OF HARRIS   §

BEFORE ME, the undersigned authority, on this day personally appeared J.B. Belin, Jr., the President of J.B.-G.P., L.L.C., General Partner of BENTWATER ON THE NORTH SHORE, LTD., A Texas limited partnership known to me to be the person whose name is subscribed to the foregoing instrument, and acknowledged to me that he executed the same for the purpose and consideration therein expressed, in the capacity therein stated and as the act and deed of said corporation.

SIGNED this the 27 day of October, 2000.

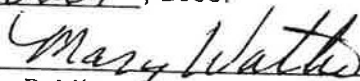
  
\_\_\_\_\_  
Notary Public - State of Texas

Please return to:  
Bentwater O.T.N.S., Ltd.  
17210 West FM 1097  
Montgomery, Texas 77356





2000-037298

45

DECLARATION  
OF  
COVENANTS, CONDITIONS AND  
RESTRICTIONS

BENTWATER SECTION 56

Please return to:

Bentwater on the North Shore, Ltd.  
17210 West FM 1097  
Montgomery, Texas 77356

**CERTIFIED COPY CERTIFICATE**  
STATE OF TEXAS  
COUNTY OF MONTGOMERY  
A true and correct copy, I hereby certify as the same  
appears under <sup>2000-037298</sup> of the Real Property  
records in the County Clerk's Office in Montgomery  
County, Texas.



MARK TURNBULL  
COUNTY CLERK  
COUNTY OF MONTGOMERY

By: Brenda Randall Deputy

## TABLE OF CONTENTS

<u>Article/Section</u>	<u>Caption</u>	<u>Page</u>
<b>ARTICLE I</b>	<b>DEFINITIONS</b>	
Section 1.01	Annexable Area	5
Section 1.02	Association	5
Section 1.03	Bentwater	5
Section 1.04	Bentwater Yacht & Country Club	5
Section 1.05	Board of Trustees	6
Section 1.06	Builders	6
Section 1.07	Common Area	6
Section 1.08	Contractor	6
Section 1.09	Declarant	6
Section 1.10	Golf Course	6
Section 1.11	Lake	6
Section 1.12	Lot	6
Section 1.13	Member	6
Section 1.14	Owner	6
Section 1.15	River Authority	6
Section 1.16	Utility District	6
<b>ARTICLE II</b>	<b>RESERVATIONS, EXCEPTIONS AND DEDICATIONS</b>	
Section 2.01	Recorded Subdivision Map of the Property	6
Section 2.02	Easements	7
Section 2.03	Title Subject to Easements	7
Section 2.04	Utility Easements	7
Section 2.05	Road and Street Easements	8
<b>ARTICLE III</b>	<b>USE RESTRICTIONS</b>	
Section 3.01	Single-Family Residential Construction	9
Section 3.02	Designation of Lot Types	9
Section 3.03	Composite Building Site	9
Section 3.04	Minimum Square Footage within improvements	10
Section 3.05	Location of the Improvements upon the Lot	10
Section 3.06	Residential Foundation Requirements	11
Section 3.07	Excavation and Tree Removal	12
Section 3.08	Removal of Trees, Trash and Care of Lots During Construction of Residence	12
Section 3.09	Drainage	13
Section 3.10	Masonry Requirements	13
Section 3.11	Driveways and Walkways	14
Section 3.12	Building Inspection of Driveways, Manholes and Storm Sewer Inlets	14
Section 3.13	Carports	15
Section 3.14	Walls, Fences and Hedges	15
Section 3.15	Visual Obstruction at the Intersection of Streets	15
Section 3.16	Air Conditioning Requirements	15
Section 3.17	Disposal Unit Requirements	15
Section 3.18	Prohibition of Offensive Activities	16
Section 3.19	Use of Temporary Structures	16
Section 3.20	Storage of Vehicles or Equipment	16
Section 3.21	Mineral Operations	17
Section 3.22	Animal Husbandry	17
Section 3.23	Lot Maintenance	17
Section 3.24	Signs, Advertisements and Billboards	17
Section 3.25	Maximum Height of Antenna	18
Section 3.26	Wind Generators	18
Section 3.27	Solar Collectors	18
Section 3.28	Swimming Pools	18
Section 3.29	Drying of Clothes in Public View	19
Section 3.30	Garage Doors	19

<u>Article/Section</u>	<u>Caption</u>	<u>Page</u>
Section 3.31	Control of Sewage Effluent	19
Section 3.32	Residences and Improvements Damaged by Fire or Other Casualty	19
Section 3.33	Common Area	19
Section 3.34	Vehicles Permitted to Use Private Roads	19
Section 3.35	Landscaping	20
Section 3.36	Roofing	20
Section 3.37	Mailboxes	20
Section 3.38	Landing, Storage and Parking of Aircraft	21
Section 3.39	Storage of Material and Equipment	21
Section 3.40	Street Lighting	21
Section 3.41	Lift Stations	21
Section 3.42	Flag Poles	21
Section 3.43	Yard Art and Other Items	21
<b>ARTICLE IV</b>	<b>ARCHITECTURAL CONTROL COMMITTEE</b>	
Section 4.01	Basic Control	21
Section 4.02	Architectural Control Committee	23
Section 4.03	Effect of Inaction	24
Section 4.04	Effect of Approval	24
Section 4.05	Inspection	24
Section 4.06	Variances	24
Section 4.07	Notices of Completion and Noncompliance	25
Section 4.08	No Implied Waiver of Estoppel	25
Section 4.09	Disclaimer	25
Section 4.10	Non-Liability for Committee Action	26
<b>ARTICLE V</b>	<b>PROPERTY OWNERS ASSOCIATION, INC.</b>	
Section 5.01	Membership	26
Section 5.02	Non-Profit Corporation	26
Section 5.03	By-Laws	26
Section 5.04	Members' Rights of Enjoyment	26
Section 5.05	Delegation of Use	27
Section 5.06	Rental and Leasing	27
<b>ARTICLE VI</b>	<b>MAINTENANCE FUND</b>	
Section 6.01	Maintenance Fund Obligation	27
Section 6.02	Basis of the Maintenance Charge	27
Section 6.03	Creation of Lien and Personal Obligations	29
Section 6.04	Notice of Lien	30
Section 6.05	Liens Subordinate to Mortgages	30
Section 6.06	Purpose of the Maintenance Charge	31
Section 6.07	Exempt Property	31
<b>ARTICLE VII</b>	<b>DECLARANT'S RIGHTS AND RESERVATIONS</b>	
Section 7.01	Period of Declarant's Rights and Reservations	31
Section 7.02	Right to Construct Additional Improvements in Common Area	32
Section 7.03	Declarant's Rights to Use Common Areas in Promotion and Marketing of the Property and Annexable Area	32
Section 7.04	Declarant's Rights to Complete Development of the Subdivision	32
Section 7.05	Declarant's Rights to Grant and Create Easements	32
Section 7.06	Declarant's Rights to Convey Additional Common Area to the Association	33
Section 7.07	Annexation of Annexable Area	33

<u>Article/Section</u>	<u>Caption</u>	<u>Page</u>
<b>ARTICLE VIII</b>	<b>DUTIES AND POWERS OF THE PROPERTY OWNERS ASSOCIATION</b>	
Section 8.01	General Duties and Powers of the Association	33
Section 8.02	Duty to Accept the Property and Facilities Transferred by Declarant	33
Section 8.03	Duty to Manage and Care for the Common Area	34
Section 8.04	Duty to Pay Taxes	34
Section 8.05	Duty to Maintain Casualty Insurance	34
Section 8.06	Disbursement of Proceeds	34
Section 8.07	Damage and Destruction	34
Section 8.08	Repair, Replacement and Reconstruction	35
Section 8.09	Duty to Maintain Liability Insurance	35
Section 8.10	General Provisions Concerning Insurance	35
Section 8.11	Other Insurance and Bonds	35
Section 8.12	Duty to Prepare Budgets	35
Section 8.13	Duty to Levy and Collect the Maintenance Charge	35
Section 8.14	Duty to Prepare Annual Review	35
Section 8.15	Duties with Respect to Architectural Approval	35
Section 8.16	Power to Acquire Property and Construct Improvements	36
Section 8.17	Power to Adopt Rules and Regulations	36
Section 8.18	Power to Enforce Restrictions, Rules and Regulations	36
Section 8.19	Power to Provide Public Functions	37
Section 8.20	Power to Provide Special Services for Members	37
Section 8.21	Power to Grant Easements	37
Section 8.22	Power to Convey and Dedicate Property to Government Agencies	37
Section 8.23	Power to Borrow Money and Mortgage Common Area	37
Section 8.24	Power to Employ Manager	38
Section 8.25	Power to Engage Employees, Agents and Consultants	38
Section 8.26	Power to Charge Fees	38
Section 8.27	General Corporate Power	38
<b>ARTICLE IX</b>	<b>NATURAL GAS OR PROPANE GAS</b>	
Section 9.01	Non-Utilization Charge	38
Section 9.02	Underground Natural Gas or Propane Gas Service Connection and Meter Location	38
Section 9.03	Individual Propane Tanks	39
<b>ARTICLE X</b>	<b>ELECTRICAL SERVICE</b>	
Section 10.01	Underground Residence Electrical Service Connection	39
<b>ARTICLE XI</b>	<b>GENERAL PROVISIONS</b>	
Section 11.01	Term	39
Section 11.02	Amendments	40
Section 11.03	Amendments by Declarant	40
Section 11.04	Severability	40
Section 11.05	Mergers and Consolidations	41
Section 11.06	Liberal Interpretation	41
Section 11.07	Successors and Assigns	41
Section 11.08	Effect of Violations on Mortgagees	41
Section 11.09	Terminology	41
Section 11.10	Effect on Annexable Area	41
Section 11.11	Declarant's Rights and Prerogatives	41
Section 11.12	Accommodation	42

**DECLARATION  
OF COVENANTS, CONDITIONS AND RESTRICTIONS  
BENTWATER SECTION 56**

THE STATE OF TEXAS )(  
COUNTY OF MONTGOMERY )(

KNOW ALL MEN BY THESE PRESENTS:

This Declaration of Covenants, Conditions and Restrictions for Bentwater, Section 56 ("the Declaration") is made on the date hereinafter set forth by Bentwater on the North Shore, Ltd., a Texas Limited Partnership, hereinafter referred to as "Declarant."

WITNESSETH:

WHEREAS, Declarant is the owner of that certain property known as BENTWATER, SECTION 56, a subdivision according to the plat of said Subdivision recorded in the office of the County Clerk of Montgomery County, Texas on the 29th day of March, 2000, ("Plat") after having been approved as provided by law, and being recorded in Cabinet N, Sheets 155 & 156 of the Map Records of Montgomery County, Texas (sometimes herein referred to as the "Property" or " Subdivision"), and

WHEREAS, it is the desire of Declarant to place certain restrictions, easements, covenants, conditions, stipulations and reservations (herein sometimes referred to as the "Restrictions") upon and against such Property in order to establish a uniform plan for the development, improvement and sale of the Property, and to insure the preservation of such uniform plan for the benefit of both the present and future Owners of Lots in said Subdivision.

NOW, THEREFORE, Declarant hereby adopts, establishes and imposes upon BENTWATER, Section 56, and declares the following reservations, easements, restrictions, covenants and conditions applicable thereto, all of which are for the purposes of enhancing and protecting the value, desirability and attractiveness of said Property, which Restrictions shall run with said Property and title or interest therein, or any part thereof, and shall inure to the benefit of each Owner thereof except that no part of this Declaration shall be deemed to apply in any manner to the areas within the Subdivision identified or platted as Unrestricted Reserve A on the Plat or apply in any manner to the areas not included in the boundaries of said Plat. Declarant also declares that this Subdivision shall be subject to the jurisdiction of the "Association" (as hereinafter defined).

**ARTICLE I  
DEFINITIONS**

Section 1.01 - "Annexable Area" shall mean and refer to any additional property made subject to the jurisdiction of the Association pursuant to the provisions set forth herein, including, without limitation, any property adjacent to or in the proximity of the Property.

Section 1.02 - "Association" shall mean and refer to the Bentwater Property Owners Association, Inc., a Texas non-profit corporation and its successors and assigns.

Section 1.03 - "Bentwater" shall mean and refer to this Subdivision and any other sections of Bentwater hereafter made subject to the jurisdiction of the Association.

Section 1.04 - "Bentwater Yacht & Country Club" shall mean and refer to the yacht and country club operated by Bentwater Yacht & Country Club, Ltd., a Texas limited partnership and its successors and assigns (hereinafter referred to as the "BYCC").

Section 1.05 - "Board of Trustees" shall mean and refer to the Board of Trustees of the Association.

Section 1.06 - "Builders" shall mean and refer to persons or entities that purchase Lots and build homes thereon for third-party purchasers.

Section 1.07 - "Common Area" shall mean all real property (including the improvements thereto) within the Subdivision owned by the Association for the common use and enjoyment of the Owners and/or any other real property and improvements, including, but not limited to, private roads and streets, parks, open spaces, lakes, lake road crossings, dams, greenbelt areas and other facilities within the Common Area to which the Owners may hereafter become entitled to use.

Section 1.08 - "Contractor" shall mean and refer to the person or entity with whom an Owner contracts to construct a residential dwelling or other improvements on such Owner's Lot.

Section 1.09 - "Declarant" shall mean and refer to Bentwater on the North Shore, Ltd. and its successors and assigns.

Section 1.10 - "Golf Course" shall mean and refer to the golf course(s) owned and operated by the BYCC.

Section 1.11 - "Lake" shall mean and refer to Lake Conroe.

Section 1.12 - "Lot" shall mean and refer to any plot of land identified as a Lot or homesite on the plat of the Subdivision. For purposes of this instrument, "Lot" shall not be deemed to include any portion of any "Reserves" or "Unrestricted Reserves" (defined as the Reserves and Unrestricted Reserves shown on the Plat) in the Subdivision, regardless of the use made of such area.

Section 1.13 - "Member" shall mean and refer to every person or entity who holds a membership in the Association.

Section 1.14 - "Owner" shall mean and refer to the record Owner, whether one or more persons or entities, of fee simple title to any Lot that is a part of the Subdivision, including (i) contract sellers (a seller under a contract for deed), but excluding those having such interest merely as security for the performance of an obligation, (ii) Declarant (except as otherwise provided herein), and (iii) Builders.

Section 1.15 - "River Authority" shall mean and refer to the San Jacinto River Authority ("SJRA").

Section 1.16 - "Utility District" shall mean and refer to the Montgomery County Municipal Utility District No. 18.

## **ARTICLE II RESERVATIONS, EXCEPTIONS AND DEDICATIONS**

### Section 2.01 - Recorded Subdivision Map of the Property.

The Plat of the Subdivision dedicates for use as such, subject to the limitations as set forth therein, the private roads and streets and easements shown thereon. The Plat further establishes certain restrictions applicable to the Property. All dedications, restrictions and reservations created herein or shown on the Plat, replats or amendments of the Plat of the Subdivision recorded or hereafter recorded shall be incorporated herein and made a part hereof as if fully set forth herein, and shall be construed as being included in each contract, deed, or conveyance executed or to be executed by or on behalf of Declarant, conveying said Property or any part thereof whether specifically referred to therein or not.

Section 2.02 - Easements. Declarant reserves for public use the utility easements shown on the Plat or that have been or hereafter may be created by separate instrument recorded in the Real Property Records of Montgomery County, Texas, for the purpose of constructing, maintaining and repairing a system or systems of electric lighting, electric power, telegraph and telephone line or lines, gas lines, sewers, water lines, storm drainage (surface or underground), cable television, or any other utility the Declarant sees fit to install in, across and/or under the Property. All utility easements in the Subdivision may be used for the construction of drainage swales in order to provide for improved surface drainage of the Reserves, Common Area and/or Lots. Notwithstanding anything to the contrary contained in this Section 2.02, no sewers, electrical lines, water lines, cable television, or other utilities may be installed on said Property except as approved in writing by the Declarant. Should any utility company furnishing a service covered by the general easement herein provided request a specific easement by separate recordable document, Declarant, without the joinder of any other Owner, shall have the right to grant such easement on said Property without conflicting with the terms hereof. Any utility company serving the Subdivision and/or the Utility District shall have the right to enter upon any utility easement for the purpose of clearing and grubbing of trees and underbrush within said easement and for the purpose of installation, repair and maintenance of their respective facilities. **Neither Declarant, nor any utility company using the easements herein referred to, shall be liable for any damage done by them or their assigns, agents, employees, or servants, even if done negligently on the Property covered by said easements.**

Section 2.03 - Title Subject to Easements. It is expressly agreed and understood that the title conveyed by Declarant to any of the Lots by contract for deed or other conveyance shall be subject to any easement affecting same for roadways or drainage, water lines, gas, sewer, storm sewer, electric lighting, electric power, telegraph or telephone purposes and any other easement hereafter granted abutting the Lots. The Owners of the respective Lots shall not be deemed to own pipes, wires, conduits or other service lines running through their Lots that are utilized for or service other Lots, but each Owner shall have an easement in and to the aforesaid facilities as shall be necessary for the use, maintenance and enjoyment of his or her Lot.

Section 2.04 - Utility Easements.

(a) A ten (10) foot utility easement has been dedicated along the front of all Lots, and along the side lot line adjacent to the street right-of-ways of all corner Lots, except as otherwise indicated on the Plat.

(b) Other ground and aerial easements have been dedicated in accordance with the Plat and by separate recorded easement documents.

(c) No building shall be located over, under, upon or across any portion of any utility easement; however, the Owner of each Lot shall have the right to construct, keep and maintain concrete drives and similar improvements across the utility easement along the front of the Lot and/or along the side of corner Lots adjacent to street right-of-ways and shall be entitled to cross such easements at all times for purposes of gaining access to and from such Lots.

(d) With the prior approval of the Committee, the Owner of each Lot also shall have the right to construct, keep and maintain driveways, walkways, steps and air conditioning units and equipment over, across or upon any utility easement along the side of such Lots (the "Side Lot Utility Easement") (other than along any Side Lot Utility Easement that is adjacent to a street right-of-way) and shall be entitled, at all times, to cross, have access to and use the improvements located thereon. However, any such improvements placed upon such Side Lot Utility Easement by the Owner shall be constructed, maintained and used at Owner's risk and, as such, the Owner of each Lot subject to said Side Lot Utility Easements shall be responsible for (i) any and all repairs to the driveways, walkways, steps and air conditioning units and equipment that cross or are located upon such Side Lot Utility Easements and (ii) repairing any damage to said improvements caused by the Utility District or any public utility

in the course of installing, operating, maintaining, repairing, or removing its facilities located within the Side Lot Utility Easements.

(e) The Owner of each Lot shall indemnify and hold harmless Declarant, the Utility District and public utility companies having facilities located over, on, across or under utility easements from any loss, expense, suit or demand resulting from death, injuries to persons or damage to property in any way occurring, incident to, arising out of or in connection with said Owner's installation, maintenance, repair or removal of any permitted improvements located within utility easements, **including where such death, injury or damage is caused or alleged to be caused by the negligence of such public utility or the Declarant, their employees, officers, contractors, or agents.**

(f) In no event shall any Owner construct, maintain or use any of the above-described improvements or any other improvements within any utility easements located along the rear of such Owner's Lot.

(g) In addition to the utility easements shown on the recorded Plat, there is hereby dedicated a five (5) foot wide electric service utility easement, extending from the surface of the ground downward, and said easement being two and one-half (2 ½) feet on each side of underground electric service lines as now or hereafter constructed will extend along the route selected by Entergy/Gulf States Utilities Company from Entergy/Gulf States Utilities Company's distribution facilities to the electric meter when and as located upon Lots and Reserves in the Subdivision. Entergy/Gulf States Utilities Company shall have the right to excavate said lot easement strip and to remove objects, structures, growth or protrusions thereon.

Section 2.05 - Road and Street Easements. The roads and streets in this Subdivision are not dedicated to the public, but shall be conveyed to the Association and operated as privately owned streets by the Association with each Owner having an easement for the use and benefit of such Owner of a Lot fronting thereon or adjacent thereto, which easements shall include rights of ingress, egress and passage over and along said streets in favor of the Declarant, the Association, the Owners and their respective legal representatives, successors and assigns, guests, invitees, licensees, designees and the successors-in-title to each Lot Owner and in favor of the invitees and designees of each successors-in-title to each Lot Owner, but not in favor of the public.

Subject to the terms and conditions of this Section 2.05, the privately owned roads and streets in this Subdivision as shown on the Plat are hereby dedicated as utility easements strictly for the purpose of constructing, operating, maintaining or repairing a system(s) of electric lighting, electrical power, telegraph and telephone lines, gas lines, sewers, water lines, storm drainage (surface or underground), cable television, or any other utilities that the Declarant sees fit to install (or permit to be installed) in, across and/or under the Property. The dedication of the privately owned roads and streets as utility easements shall not affect the Association's operation of the roads and streets in this Subdivision as privately owned roads and streets, as set forth above in this Section 2.05.

Notwithstanding the Association's operation of the roads and streets in the Subdivision as privately owned streets, Declarant hereby grants to Law enforcement agencies and officers of Montgomery County and the State of Texas, other governmental law enforcement bodies, fire department officials and fire protection personnel, vehicles and equipment, ambulances, school buses, Montgomery County officials and personnel and other governmental officials and personnel rights of ingress and egress and passage over and along said privately owned roads and streets of the Subdivision in connection with the performance of such individual's or entity's official functions. Declarant reserves the right to grant access to other individuals or entities.



### ARTICLE III USE RESTRICTIONS

Section 3.01 - Single-Family Residential Construction. - No building shall be erected, altered, or permitted to remain on any Lot other than one detached, single-family dwelling used for residential purposes only and not to exceed two (2) stories in height and a private garage (or other approved covered parking facility) and other bona fide servant's quarters. The servant's quarters structure and garage may not exceed the main dwelling in height or number of stories.

Occupancy shall be limited to one (1) family, which shall be defined as any number of persons related by blood, adoption or marriage living with not more than one (1) person who is not so related as a single household unit, or no more than two (2) persons who are not so related living together as a single household unit. It is not the intent of the Declarant to exclude any individual from a dwelling who is authorized to so remain by any state or federal law. If it is found that this section, or any other section, of the Declaration is in violation of any law, then the prohibited section shall be interpreted to be as restrictive as possible to preserve as much of the original section as allowed by law.

All garages must be attached to the main residence and must not be nearer to the front lot line or rear lot line than the building setback line as set out for the residence and attached garage in Section 3.05. Each residence shall have a fully enclosed garage for not less than two (2) cars, which garage is available for parking automobiles at all times without any modification being made to the interior of said garage.

As used herein, the term "residential purposes" shall be construed to prohibit mobile homes or trailers being placed on said Lots, or the use of said Lots for duplex houses, condominiums, townhouses, garage apartments, or apartment houses. No Lot shall be used for business, educational; church or professional purposes of any kind whatsoever, nor for any commercial or manufacturing purposes whether for profit or not.

Except as otherwise provided in Section 3.19, no portable or permanent buildings of any type or character shall be moved or placed upon any Lot. Buildings of every type and character, whether attached to or detached from the main residential structure or garage constructed on the Lots, must be approved by the Committee prior to the commencement of the construction of such buildings.

All attached garages shall open to the side or to the rear of the Lot upon which such garage is built, except that a garage may open to the front of the Lot if the front of the garage is set back at least fifteen (15) feet from the front of the heated/air conditioned portion of the main dwelling. The fifteen (15) foot measurement should be so that no portion of the garage is less than fifteen (15) feet from the portion of the front of the main dwelling which is furthest from the front property line, unless otherwise approved by the Committee.

#### Section 3.02 - Designation of Lot Types.

- (a) Golf Estate Lots: Block 2, Lots Seven (7) through Ten (10).
- (b) County Estate Lots: Block 1, Lots One (1) through Nine (9) and Block 2, Lots One (1) through Six (6).

Although this Declaration may include references to other Lot types, such as Lake Estate Lots, Golf Course Lots, Lakefront Lots and Town and Country Lots, the Subdivision contains only the Lot types described above in this Section 3.02 and any references to other Lot types are not applicable to the Subdivision.

Section 3.03 - Composite Building Site. Any Owner of one or more adjoining Lots (or portions thereof) facing the same street or right of way may, with the prior written approval of the Committee, consolidate such Lots or portions into one building site, with the privilege of placing or constructing improvements on such resulting site. If such consolidation

is approved, the side setback lines shall be measured from the resulting side property lines rather than from the lot lines as indicated on the Plat. Any such composite building site must have a frontage at the building setback line of not less than the minimum frontage of all Lots in the same block unless otherwise approved by the Committee. In addition, the Side Lot Utility Easement must be abandoned or released in accordance with applicable law and at the expense and obligation of the Owner. Upon such abandonment or release and upon the receipt of written approval of the Committee, such resulting composite building sites shall thereupon be regarded as one (1) "Lot" for all purposes hereunder, until such time as the Lots are separated in any manner. Any such composite building site (or building site resulting from the remainder of one or more Lots having been consolidated into a composite building site) must contain not less than 13,000 square feet in area for Country Estate Lots and 10,800 square feet for Golf Estate Lots.

Section 3.04 - Minimum Square Footage within Improvements. The minimum living area of the main residential structure located on any Lot, exclusive of porches, garages and/or parking facilities, shall be as follows:

Golf Estate Lots and Country Estate Lots: Minimum living area of all lots shall be not less than 2,400 square feet for a one-story dwelling and 2,600 square feet for a two-story dwelling.

Section 3.05 - Location of the Improvements upon the Lot. No residential structure, carport or any other improvement shall be located on any Lot nearer to the front, rear, side or street-side lot building line shown on the Plat or nearer to the property lines than the minimum building setback lines shown in the table below, as modified by the notes described below the table. For purposes of this Declaration, air compressors, eaves, steps and unroofed terraces shall not be considered as part of a residential structure or other improvement. This covenant shall not be construed to permit any portion of a building foundation on a Lot to encroach upon an easement. The main residential structure on any Lot shall face the front of the Lot as determined by the Committee in its sole and absolute discretion, except as described below or unless a deviation is approved in writing by the Committee.

The setbacks as shown within the Declaration and the Plat are minimum setback lines and the Committee may approve a residential structure to be located a greater distance from a property line than the setback lines provided within the Plat or this Declaration.

The Declarant, Committee and Association are not liable to any Owner for any impairment of view as a result of the construction of any improvements upon another Lot, built or to be constructed pursuant to plans approved by the Committee.

TABLE OF BUILDING SETBACK REQUIREMENTS				
LOT DESIGNATION	FRONT BUILDING SETBACK	REAR BUILDING SETBACK	SIDE BUILDING SETBACK	CORNER LOT SIDE BUILDING SETBACK
Golf Estate (1)(2)(6)				
Blk 2 Lots 7 - 10	25 Ft.	20 Ft.	5 Ft.	N/A
Country Estate (2)(5)(6)				
Blk 1 Lots 1 - 9	25 Ft.	20 ft.	5 Ft.	N/A
Blk 2 Lots 1 - 6	25 Ft.	20 Ft.	5 Ft.	N/A

(1) SPECIAL RESTRICTIONS FOR THE FOLLOWING LOTS

Block 2, Lot Seven (7) - See special restrictions for rear lot fencing for Block 2, Lot 7 under Section 3.14 Walls, Fences and Hedges.

- (2) No out building, opaque fence or wall may be constructed within the rear setback of Lots abutting the Golf Course or Lake Conroe, except, however, other improvements including unroofed terraces and such other structures as approved by the Committee which do not unreasonably block the view of adjoining Lots as approved by the Committee may be constructed within the rear building setback of Lots abutting the golf course or Lake Conroe.

A swimming pool may be constructed within the rear building setback of Lots as set out in Section 3.28. Other improvements may be approved by the Committee to be constructed within the rear building setback of Interior Lots. The Committee shall have the sole authority to grant or deny, without liability, the construction of any such proposed improvements within the rear building setback of the Lot.

- (3) On corner Lots, the front of the Lot shall be defined as the principal side of the Lot having the lesser street frontage. The side building setback line will be measured on the side of the Lot facing the larger street frontage.
- (4) If a house on a corner Lot is constructed with the front or main entrance facing the side of the larger street frontage, the required front setback line will be twenty five (25) feet and the house must be constructed behind the original front building setback line as shown on the plat.
- (5) A detached garage may be constructed on Country Estate Lots.
- (6) Any garage located on a lot abutting the golf course or Lake Conroe must be attached to the main residence and must not be nearer to the front Lot line or rear Lot line than the building setback lines as set out for the residence and attached garage in this Section 3.05. All attached garages as set out in Article 3.01 shall open to the side or to the rear of the Lot upon which such garage is built, except that a garage may open to the front of the Lot if location of the garage is in accordance with the requirements as set out under Section 3.01.

Section 3.06 - Residential Foundation Requirements. All building foundations shall consist of concrete slabs, unless the Committee approves a different type of foundation when circumstances such as the topography of the Lot make it impractical to use a concrete slab for all or any portion of the foundation of the building improvements constructed on the Lot. Minimum finished slab elevation for all structures shall be Twelve Inches (12") above the higher of (i) the 100 year flood plain elevation, or (ii) such other level as may be established by the Commissioner's Court of Montgomery County, Texas, and other applicable governmental authorities. In no case will a slab be lower than an elevation of 207.0 MSL or as approved or required by the Committee.

The minimum finished slab elevation must also be a minimum of twelve inches (12") above the finished grade of the Lot at the foundation perimeter. Finished grade of the Lot shall be defined as the final grade or elevation of the Lot and other improvements including but not necessarily limited to fill placed on the Lot, flower beds and other landscaping, walks, drives, etc. It is the purpose of this minimum elevation difference requirement to protect the residence from receiving surface waters in the event of a major rain storm. The Committee may approve a request for the slab elevation of a residence to be less than twelve inches (12") above the finished grade of a Lot, however, regardless of the elevation difference approved by the Committee, it is the responsibility of the Builder and/or Owner to provide satisfactory drainage around a residence and garage. Drainage requirements for each lot will vary and Builder and/or Owner should hire a licensed engineer to design a drainage plan for the specific lot upon which a house is to be constructed prior to beginning house construction.

The minimum height for slab elevations (i.e. the difference between the slab elevation and the finished grade of the Lot at the foundation perimeter as set out in this Section 3.06) is not a representation that such slab elevation would prevent surface water flow or rising water in the event of a major rain storm from entering into a residence or garage. Builders and/or Lot Owners should consider the collective drainage area of all surrounding land around

the Lot, including without limitation, golf course, reserves, common areas, streets and their drainage collection area, existing drainage and other Lots, in reaching their determination of the proper slab elevation and Lot drainage plan to avoid surface water flow or rising water from entering into the residence or garage in the event of a major rain storm. Additionally, the Builder and/or Lot Owner should take into account how other improvements and landscaping are to be constructed upon their Lot will affect drainage and water flow.

All references in this Declaration to required minimum slab elevations and/or any slab elevations approved by the Committee do not constitute a guaranty by the Declarant, the Committee or the Association that the residence will be free of flood or related damage.

All foundations are required to be engineered and designed by a licensed, registered engineer based upon appropriate soils information taken from the specific Lot in question as recommended by such engineer. However, at a minimum, soils borings and soils reports by a qualified soils engineer are required for all Lots prior to such engineer's design of the foundation.

The residential foundation plans to be used in the construction of the residence must be submitted to the Committee along with the plans and specifications for the residence as provided in Section 4.01. All foundation plans must be signed, sealed and dated by the engineer designing said foundation plans. The Committee and/or Declarant shall rely solely upon Owner/Builder's engineer as to the adequacy of said foundation design when issuing architectural approval of the residence to be constructed. No independent evaluation of the foundation plan is being made by the Committee. The Committee's sole function as to foundation plans are to determine if the plans have been prepared by a licensed registered engineer, as evidenced by the placement of an official seal on the plans.

The Owner/Builder shall establish and construct the residence and garage slab at an elevation sufficient to avoid water entering into the residence and garage in the event of a heavy rain. A special drainage structure, as recommended and designed by a licensed engineer and/or residence wherein the slab elevation is lower than the street gutter.

The granting of approvals of foundation plans and the residence and garage slab elevation shall in no way serve as warranty as to the quality of the plans and specifications and/or that residence shall be free from flood damage from rising or wind driven water or the flow of surface water from other locations within Bentwater and in no event shall the Declarant, the Committee or the Association have any liability as a result of the Committee's approval or disapproval of the resulting improvement.

Section 3.07 - Excavation and Tree Removal. The digging of dirt or the removal of any dirt from any Lot is expressly prohibited except as may be necessary in conjunction with the landscaping of or construction of improvements on such Lot. No trees shall be cut or removed except to provide room for construction of improvements or to remove dead or unsightly trees.

Section 3.08 - Removal of Trees, Trash and Care of Lots During Construction of Residence.

(a) All Owners, during their respective construction of a residence, are required to remove and haul from the Lot all tree stumps, trees, limbs, branches, underbrush and all other trash or rubbish cleared from the Lot for construction of the residence, construction of other improvements and landscaping. No burning is allowed on the Lot and no materials or trash hauled from the Lot may be placed elsewhere in the Subdivision or on land owned by Declarant whether adjoining the Subdivision or not.

(b) All Owners, during their respective construction of a residence, are required to continuously keep the Lot in a reasonably clean and organized condition. Papers, rubbish, trash, scrap and unusable building materials are to be kept picked up and hauled from the Lot. Other usable building materials are to be kept stacked and organized in a reasonable manner upon the Lot.

(c) No trash, materials or excess dirt is allowed in the street or street right-of-way. All Owners shall keep the street and street right-of-way free from trash, materials and excess dirt. Any such trash, materials or excess dirt or fill inadvertently spilling or getting into the street or street right-of-way shall be removed, without delay, not less frequently than daily.

(d) No Owner or Contractor may enter onto a Lot adjacent to the Lot upon which he or she is building for purposes of ingress and egress to his or her Lot during or after construction, unless such adjacent Lot is also owned by such Owner. All such adjacent Lots shall be kept free of any trees, underbrush, trash, rubbish and/or any other building or waste materials during or after construction of building improvements by the Owner of an adjacent Lot.

#### Section 3.09 - Drainage.

(a) Each Owner of a Lot agrees for himself or herself, his or her heirs, legal representatives, assigns or successors-in-interest that he or she will not in any way interfere with the established drainage pattern over his or her Lot from adjoining Lots or other Lots in the Subdivision; and he or she will make adequate provisions for the drainage of his or her Lot in the event it becomes necessary to change the established drainage over his or her Lot (which provisions for drainage shall be included in the Owner's plans and specifications submitted to the Committee and shall be subject to the Committee's review). For the purposes hereof, "established drainage" is defined as the drainage that existed at the time that the overall grading of the Subdivision, including landscaping of any Lot in the Subdivision, was completed by Declarant.

(b) All Owners (including Builders), unless otherwise approved by the Committee, must finish the grade of their respective Lots so as to establish good drainage from the rear of the Lot to the front street or from the building site to the front and rear of the Lot as dictated by Lake Conroe, existing drainage ditches, swales and lakes constructed by Declarant or the Utility District for drainage purposes. No pockets or low areas may be left on the Lot (whether dirt or concrete) where water will stand following a rain or during watering. With the review of the Committee, an Owner may establish an alternate drainage plan for low areas by installing underground pipe and area inlets or by installing an open concrete trough with area inlets, however, the drainage plan for such alternate drainage must be submitted to and reviewed by the Committee prior to the construction thereof. The Committee's sole function in reviewing drainage plans is to see if the drainage pattern has been or will be altered by the proposed construction and to make a determination if the Owner/Builder has evaluated the effects of their construction to other properties and of the effect of potential flowing and rising water that may affect the submitted improvements.

(c) Drainage requirements to insure water does not enter a house or garage during a major rainstorm will vary and Builder and/or Owner should hire a licensed engineer to design a drainage plan for the specific lot upon which a house is to be constructed prior to beginning house construction. It is the responsibility of the Builder and/or Owner to provide satisfactory drainage around a residence and garage.

(d) In no case shall the street curb be broken or cut to facilitate drainage or drain pipes without first obtaining the Committee's approval for the design and construction of an approved curb cut.

(e) All Owners and/or Builders shall comply with the National Pollutant Discharge Elimination Systems Permit ("NPDES Permit") applicable to their respective Lot(s) as required by EPA under the Water Quality Act of 1987 amending the Clean Water Act, as said laws, rules and regulations may be amended from time to time.

Section 3.10 - Masonry Requirements. Without the prior approval of the Committee, no residences (including attached or detached garages) shall have less than fifty-one percent (51%) masonry construction or its equivalent on the exterior wall areas. All residences on Lake Estate Lots and Golf Estate Lots shall be constructed with the dwelling walls, including garages, facing the Golf Course or Lake being one hundred percent (100%) masonry. All chimneys shall be masonry construction.

Section 3.11 - Driveway and Walkways.

(a) Driveways shall be constructed entirely of concrete and that portion of the concrete driveway that lies on the Lot shall be constructed a minimum width of nine (9) feet. That portion of the concrete driveway that lies between the front property line and the street shall be a minimum width of ten (10) feet and the driveway shall be constructed in accordance with the detail, design and specifications as shown on Exhibit "A" attached hereto and incorporated herein by reference for all purposes. All concrete driveways must have a minimum of No. 6, 6" x 6" wire mesh and five (5) sack concrete.

(b) Concrete roll-up curbs shall not be saw cut or broken when constructing the concrete driveway. Concrete standard curbs ("stand-up curbs") are to be saw cut and may not be broken when constructing the concrete driveway. An expansion joint shall be installed at each saw cut.

(c) Concrete curbs that are chipped, cracked and/or broken on the street front or street side of all Lots are to be repaired or replaced by the Builder or Owner of the residence on each Lot prior to the occupancy of the residence on said Lot. Chipped curbs may have patched repairs using an "epoxy grout" mixture. Where several curb chips appear in the same area, the entire section of the curb (i.e. driveway to driveway) must be overlaid with the "epoxy grout" mixture. Cracked or broken up curbs shall be saw cut on both sides of the crack or break, the cracked or broken area removed, reformed and poured using five (5) sack concrete mix and reinforcing steel rebar and placing an expansion joint on each side of the curb cut, as more particularly described in Exhibit "A."

(d) Owner shall at all times keep his or her driveway entrance (i.e. concrete driveway, driveway entrance lip, driveway curbs, and driveway curb ties) and the curbs along the street front or street side in a good state of repair and attractive appearance.

In the event of any default by the Owner or other occupant of a Lot in observing the above requirements, which default is continuing after thirty (30) days written notice thereof to the Owner or occupant, as applicable, the Declarant or the Association or their designated agents have the right but not the obligation, without liability to the Owner, Contractor or any occupants of the Lot in trespass or otherwise, to enter upon (and/or authorize one or more others to enter upon) said Lot and make such repairs as deemed necessary by the Declarant or Association to secure compliance with this Declaration, so as to place such driveway entrance and street curbs in a good state of repair and attractive appearance. The Declarant and/or the Association may charge the Owner, Builder or occupant of such Lot for the cost of such work and associated materials. Payment thereof shall be collected by adding the charges to the hereinafter described Maintenance Charge (secured by a maintenance lien, as described in Section 6.03) and shall be payable on the first day of the next calendar month with the regular monthly Maintenance Charge payment.

(e) Manholes, valve boxes and storm sewer inlets constructed by the Utility District located within driveways must be rebuilt and/or modified, at the Owner's expense, in accordance with detail, design and specifications as shown on Exhibit "B" attached hereto and incorporated herein by reference for all purposes. Manholes and valve boxes located on the Lot that require adjustment due to fill placed on the Lot during the construction of the residence must be so modified at the Owner's expense in accordance with detail, design and specification as shown on Exhibit "B" attached hereto. Every Owner shall obtain permission from the Utility District to adjust or rebuild manholes, valve boxes and storm sewer inlets prior to any construction of the Owner's residence and, if approved by the Utility District, the adjustment will conform to the Utility District's construction and inspection requirements and to the requirements of Exhibit "B" attached hereto.

(f) No walkways or sidewalks shall be constructed across the front of any Lots, and no sidewalks shall be constructed along the street side of any corner Lots.

Section 3.12 - Building Inspection of Driveways, Manholes and Storm Sewer Inlets.

In order to control the construction of the work described in Section 3.11, a construction (building) inspection is required to be made prior to and after pouring concrete for driveways.

Fees, in an amount to be determined by the Committee, must be paid to the Committee prior to architectural approval of such residential improvements to defray the expense for before and after inspections of the driveways. In the event construction requirements are incomplete or rejected at the time of inspection and it becomes necessary to have additional building inspections, a fee, in an amount to be determined by the Committee, must be paid to the Committee prior to each building inspection.

Prior to requesting an inspection of the driveways, the Contractor of any residence, whether the Owner or a Builder, is required to prepare driveways complete with excavation, compaction, forms, steel and expansion joints as set out in Section 3.11 and as shown in Exhibit "A." The Contractor shall not pour the concrete until after the Committee furnishes written approval of such construction to the Owner.

The sole purpose of the Committee causing to be inspected driveways is to make a determination that the improvements as constructed will not cause a negative impact upon the common areas, including but not limited to the privately owned streets.

Section 3.13 - Carports. No carport shall be erected or permitted to remain on any Lot without the express prior written approval of the Committee. Said approval will be denied unless the carport is shown to be an integral part of the residence and the carport is constructed with the same design, color and materials as the residence.

Section 3.14 - Walls, Fences and Hedges.

(a) No wall, fence, planter or hedge in excess of two (2) feet high shall be erected, planted or maintained (i) nearer to the front property line than the front building setback line or (ii) on corner Lots nearer to the side Lot line than the building setback line parallel to said side street.

(b) No wall, fence, planter or hedge shall be more than six (6) feet high. No opaque wall, fence or hedge may be erected, planted or maintained within the rear building setback line on Lots abutting the Golf Course.

(c) An ornamental iron or other decorative fence of a design and color approved by the Committee may be constructed between the front building setback line and the rear property line of golf course lots. A wood fence may not be constructed.

(d) Special Restrictions Section 56, Block 2, Lot Seven (7): Fencing for Section 56, Block 2, Lot 7, if installed, must be constructed entirely of ornamental iron.

(e) A wood fence, the specifications of which must be approved by the Committee, may be constructed between the front building setback line and the rear property line of Country Estate lots.

Section 3.15 - Visual Obstruction at the Intersection of Streets. No planting or object that obstructs sight lines at elevations between two (2) feet and six (6) feet above the roadways within the triangular area formed by the intersecting street property lines and a line connecting them at points twenty-five (25) feet from the intersection of the street property lines or extension thereof shall be placed, planted or permitted to remain on any corner Lots unless otherwise approved by the Committee.

Section 3.16 - Air Conditioning Requirements. No window or wall type air conditioning unit shall be permitted to be used, erected, placed or maintained in or on any building in any part of the Subdivision. No air conditioner compressor may be located in front of a house or on the side of a house facing a street.

Section 3.17 - Disposal Unit Requirements. Each kitchen in each residential dwelling or servant's quarters situated on any Lot shall be equipped with a garbage disposal unit, which garbage disposal unit shall at all times be kept in a serviceable condition.



Section 3.18 - Prohibition of Offensive Activities. Without expanding the permitted uses of the Lots, no activity, whether for profit or not, shall be conducted on any Lot that is not related to single-family residential purposes. No noxious or offensive activity of any sort shall be permitted nor shall anything be done on any Lot that may be or may become an annoyance or a nuisance to the Subdivision. This restriction is waived in regard to the customary sales activities required to sell homes in the Subdivision and the lighting effects utilized to display the model homes. No exterior speaker, horn, whistle, bell or other sound device, except alarms, sirens, alarms monitoring devices and fire devices used exclusively for interior warning and fire purposes, shall be located, used or placed on a Lot. The Board of Trustees shall have the sole and absolute discretion to determine what constitutes a nuisance or annoyance. Activities expressly prohibited, include, without limitation, (i) the performance of work on automobiles or other vehicles upon the Lot or in driveways or streets abutting Lots, (ii) the use or discharge of firearms, firecrackers or other fireworks within the Subdivision, (iii) the storage of flammable liquids in excess of five (5) gallons, or (iv) other activities that may be offensive by reason of odor, fumes, dust, smoke, noise, vibration or pollution, or that are hazardous by reason of excessive danger, fire or explosion.

As indicated above, no Lot in the Subdivision shall be used for any commercial, educational, manufacturing, business or professional purpose nor for church purposes. The renting or leasing of any residential dwelling is subject to the provisions of Section 5.06.

No Lot or other portion of the Subdivision shall be used or permitted to be used for hunting or for the discharge of any pistol, rifle, shotgun, or any other firearm, or any bow and arrow or any other device capable of killing or injuring persons.

Section 3.19 - Use of Temporary Structures. No structure of a temporary character, whether trailer, basement, tent, shack, garage, barn or other out building shall be maintained, used or permitted to remain on any Lot at any time as a residence, or for any other purpose, either temporarily or permanently; provided, however, that Declarant reserves the exclusive right to erect, place and maintain such facilities in or upon any portion of the Subdivision as in its' sole discretion may be necessary or convenient while selling Lots, selling or constructing residences and constructing other improvements within the Subdivision. Such facilities may include, but not necessarily be limited to, sales and construction offices, storage areas, model units, signs and portable toilet facilities.

Section 3.20 - Storage of Vehicles or Equipment.

(a) No motor vehicle or non-motorized vehicle (including without limitation, trucks and recreation vehicles), trailers, campers, motorcycles, off-road motor bikes, bicycles, golf carts, go-carts, machinery or equipment of any kind may be parked or stored for longer than ten (10) hours or on a semi-permanent or daily basis on any part of a Lot, driveway, private road or street, easement, right-of-way, or Common Area unless such vehicle or object is completely concealed from public view inside a garage or approved enclosure. Notwithstanding the ten (10) hour parking restriction, there shall be no overnight parking on any road or street. Passenger automobiles, passenger vans or pick-up trucks that are in operating condition and not in a state of disrepair, having current license plates and inspection stickers, and that are in daily use as motor vehicles on the streets and highways of the State of Texas are exempt from the ten (10) hour parking and the overnight parking on the street in front of the residence restrictions; however, such parking shall not be continuous and shall not exceed forty-eight (48) hours in duration. No vehicle may be repaired on a street or repaired on a Lot unless such vehicle is concealed inside a garage or other approved enclosure during the repair thereof.

(b) Boats and boat trailers may be parked in the Owner's driveway for a period not longer than forty-eight (48) hours in duration (but in no event on a semi-permanent or daily basis); however, boats and boat trailers may not be parked on the street. Boats and boat trailers must be completely concealed from public view inside a garage or approved enclosure if they are parked or stored on a Lot for more than forty-eight (48) hours.

(c) This restriction shall not apply to any vehicle, machinery or equipment temporarily parked and in use for the construction, repair or maintenance of (i) residential dwelling(s) or



related improvements in the immediate vicinity thereof or (ii) utility improvements in the Subdivision.

Section 3.21 - Mineral Operations. No oil drilling, oil development operations, oil refining, quarrying or mining operation of any kind shall be permitted upon or in any Lot, nor shall any wells, tanks, tunnels, mineral excavation, or shafts be permitted upon or in any Lot. No derrick or other structures designed for the use of boring for oil or natural gas shall be erected, maintained or permitted upon any Lot. At no time shall the drilling, usage or operation of any water well be permitted on any Lot, except that the Committee may, in its' discretion, allow water wells to be drilled for homes requiring water wells for solar heating and cooling purposes. The prohibition of water wells shall not in any manner be deemed to apply to the Reserves designated on the Plat or to any land within the Subdivision or Annexable Area owned by the Declarant or Association, whether adjacent hereto or not.

Section 3.22 - Animal Husbandry. No animals, livestock, bees or poultry of any kind shall be raised, bred or kept on any Lot except that dogs, cats or other common household pets may be kept provided that they are not kept, bred or maintained for commercial purposes and do not become a nuisance or threat to other Owners. No more than two (2) of each type of animal shall be kept as household pets. No Owner shall permit any dog, cat or other domestic pet under his or her ownership or control to leave such Owner's Lot unless leashed and accompanied by a responsible member of such Owner's household.

Section 3.23 — Lot Maintenance.

(a) All Lots shall be kept at all times in a neat, attractive, healthful and sanitary condition. The Owner or occupant of a Lot shall keep all weeds and grass thereon cut and shall in no event use such Lot for storage of materials or equipment except for normal residential requirements or incidental to construction of improvements thereon as herein permitted. An Owner shall not permit the accumulation of garbage, trash or rubbish of any kind thereon and shall not burn any garbage, trash or rubbish. All yard equipment or storage piles shall be kept screened by a service yard or other similar facility as herein otherwise provided, so as to conceal such equipment or piles from view of neighboring Lots, streets or other property.

(b) In the event of any default by the Owner or other occupant of any Lot in observing the above requirements or the requirements of Section 3.08, which default is continuing after ten (10) days written notice thereof to the Owner or occupant, as applicable, the Declarant or the Association or their designated agents have the right but not the obligation, without liability to the Owner, Contractor or any occupants of the Lot in trespass or otherwise, to enter upon (and/or authorize one or more others to enter upon) said Lot, cut, or cause to be cut, such weeds and grass and remove, or cause to be removed, such garbage, trash and rubbish or do any other thing necessary to secure compliance with this Declaration, so as to place said Lot in a neat, attractive, healthful and sanitary condition, and may charge the Owner, Builder or occupant of such Lot for the cost of such work and associated materials. Payment thereof shall be collected by adding the charges to the Maintenance Charge (secured by a maintenance assessment lien, as described in Section 6.03) and shall be payable on the first day of the next calendar month with the regular monthly Maintenance Charge payment.

Section 3.24 - Signs, Advertisements and Billboards. No sign, advertisement, billboard, or advertising structure of any kind may be erected or maintained on any Lot or be visible from any improvement upon a Lot in the Subdivision without the prior approval of the Committee and any such approval that is granted may be withdrawn at any time, in which event, the parties granted such permission shall immediately remove such structures. The Committee shall have the right from time to time to promulgate reasonable rules and regulations regarding signs. Additionally, no street or directional signs may be installed within the Subdivision without the prior written approval of the Declarant and the Committee.

The Declarant or the Association (and/or any agent designated by Declarant or the Association) shall have the right to remove and dispose of any such prohibited sign, advertisement, billboard or advertising structure that is placed on any Lot, and in doing so

shall not be subject to any liability for trespass or any other tort in connection therewith or arising from such removal nor in any way be liable for any accounting or other claim by reason of the disposition thereof.

Section 3.25 - Maximum Height of Antenna. No external antennas, aerials, satellite dishes (of one [1] meter or less in diameter), or other apparatus for the reception of television, radio, satellite or other signals of any kind shall be placed, allowed, or maintained upon any portion of the property, including any homesite, which is visible from any street, common area or other Lot unless it is impossible to receive signals from said location. In that event the receiving device may be placed in a visible location only as approved by the Committee. The Committee may require as much screening as possible while not substantially interfering with reception. No broadcast or MMDS antenna mast may exceed the height of ten (10) feet above the center ridge of the roof line. No exterior antennas, aerials, satellite dishes, or other apparatus shall be permitted which transmit television, radio, satellite or other signals of any kind shall be placed, allowed, or maintained upon any portion of the property. No satellite receiving dish in excess of one (1) meter may be erected or installed without the prior written approval of the Committee. In order to ensure the aesthetic standards of the property, no satellite receiving dish may be erected or installed that extends more than six (6) feet above the natural grade, and every satellite receiving dish shall be enclosed with a six (6) foot high fence or wall constructed so that the dish is not visible at ground level from adjoining Lots, streets, common areas, the lake or the golf course. The Declarant by promulgating this section is not attempting to violate the Telecommunications Act of 1996 ("the Act"), as may be amended from time to time. This section shall be interpreted to be as restrictive as possible while not violating the Act.

Section 3.26 - Wind Generators. No wind generators shall be erected or maintained on any Lot if said wind generator is visible from any other Lot or public street.

Section 3.27 - Solar Collectors. No solar collector shall be installed without the prior written approval of the Committee. Such installation shall be in harmony with the design of the residence. Solar collectors shall be installed in a location not visible from the public street in front of the residence.

Section 3.28 - Swimming Pools. Above ground swimming pools are prohibited. No swimming pool may be constructed on any Lot without the prior written approval of the Committee. Each application made to the Committee shall be accompanied by two sets of plans and specifications for the proposed swimming pool construction to be done on such Lot, including a plot plan showing the location and dimensions of the swimming pool and all related improvements, together with the plumbing and excavation disposal plan. The Committee's approval or disapproval of such swimming pool shall be made in the same manner as described in Article IV hereof for other building improvements. Swimming pool drains shall be piped into the lake, storm sewer or gutter in front of the Lot. In no case shall the street curb be broken or cut to facilitate a pool drain without the prior written approval of the Committee. Excavation required for swimming pools shall be hauled from the site to a place outside of the Bentwater Subdivision.

Swimming pools approved for construction by the Committee must be constructed prior to beginning construction of the Residence or approval in writing must be obtained from the Owner(s) of the adjacent Lot(s) to use said Owner's Lot to gain ingress and egress over and across said Lot for purposes of constructing the swimming pool. No portion of the Golf Course may be used during the construction of a swimming pool. In the event a swimming pool is to be constructed on a lake front Lot, Owner must hire a registered professional Civil Engineer to provide design plans and specifications for improvements required to support the existing bulkhead and swimming pool. Such plans and specifications and/or approval in writing from the adjacent Lot Owner authorizing use of his or her property to gain access for swimming pool construction must be submitted to the Committee for approval as provided in Section 4.01. The Committee shall rely solely upon Owner/Builder's engineer as to the adequacy of the bulkhead support design and swimming pool design when issuing architectural approval of the swimming pool and bulkhead support systems.

Subject to the restrictions for swimming pools as set out in this Section 3.28, a swimming pool approved by the Committee may be located within the rear building setback of a Lot, however, nothing herein shall allow a swimming pool to encroach upon a utility easement. At the option of the Committee, the Committee may approve the construction of a swimming pool that will encroach upon a utility easement upon receipt of satisfactory proof that: (1) the subject easement has been abandoned by law, or (2) a consent for the encroachment of said swimming pool together with a survey or plat showing such proposed encroachment has been approved and executed by each utility company providing utility service of every type and character and approved and executed by the Utility District. Swimming pools constructed within the rear building setback on Lots abutting the golf course or Lake Conroe may not have a screen or cover of any type without the prior written approval of the Committee. Swimming pools constructed within the rear building setback of Interior Lots, with the prior approval of the Committee, may have a screen or cover that has a quality design approved by the Committee. The Committee shall have the sole authority to determine whether or not such swimming pool screen or cover design is acceptable and may grant or deny, without liability, the construction of such screen or cover based upon the Committee's opinion of the design, location, quality and appearance of said screen or cover.

A swimming pool may not be constructed wherein the top of the swimming pool is at an elevation lower than 203 feet above mean sea level (MSL). While the FEMA 100 year flood plain, as of the date of these restrictions is 203 MSL, the Lake Conroe pool elevation may rise higher than 203 MSL in the event of a major rain storm.

Section 3.29 - Drying of Clothes in Public View. The drying of clothes in public view is prohibited, and the Owners or occupants of any Lots at the intersection of streets or adjacent to parks, playgrounds, Golf Course, Lake or other facilities where the rear yard or portion of the Lot is visible to the public, shall construct and maintain a drying yard or other suitable enclosure to screen drying clothes from public view.

Section 3.30 - Garage Doors. Garage doors visible from any street shall be kept in the closed position when the garage is not being used by the Owner or occupant. All garage doors must be equipped with an electrically operated automatic door closer.

Section 3.31 - Control of Sewage Effluent. No outside toilets will be permitted, and no installation of any type of device for disposal of sewage shall be allowed that would result in raw or untreated or unsanitary sewage being carried in the streets or into any body of water. No septic tank or other means of sewage disposal will be permitted.

Section 3.32 — Residences and Improvements Damaged by Fire or Other Casualty. Any buildings or other improvements within the Subdivision that are destroyed partially or totally by fire, storm or any other casualty, shall be repaired or demolished within a reasonable period of time, and the Lot and improvements thereon, as applicable, restored to an orderly and attractive condition.

Section 3.33 - Common Area. Any Common Area shall be used only for streets, roads, paths, recreation, utility easement, drainage purposes, and Lot purposes reasonably connected therewith or related thereto; provided, however, no residential, professional, commercial, educational or church use shall be made of any Common Area.

Section 3.34 - Vehicles Permitted to Use Private Roads.

(a) The only motorized vehicles allowed on the roads and street easements in the Subdivision shall be (i) motor vehicles currently licensed and inspected for use on public highways or (ii) golf carts with a current permit issued by the Bentwater Yacht & Country Club; provided, however, golf carts shall be operated in the Subdivision solely for purposes of access to and from the Bentwater Yacht & Country Club. The Declarant retains the right to allow individuals to use golf carts for other limited uses.

(b) The use of non-licensed motor vehicles including, but not limited to, automobiles, trucks, motorcycles, dirt bikes, off-road vehicles and go-carts is expressly prohibited.

(c) Vehicles, regardless of type, may only be operated by individuals holding a current driver's license valid in the State of Texas.

(d) Licensed motorized two-wheel or three-wheel vehicles shall be allowed within the Subdivision solely for the purpose of access to and from the Subdivision and access to and from the Bentwater Yacht & Country Club, but shall not be permitted for travel within the Subdivision.

(e) Vehicles, tractors, mowers, trailers or other construction and maintenance equipment used in the construction and maintenance of the Subdivision, construction of sections within Bentwater and the construction and maintenance of the Bentwater Yacht & Country Club, marina, golf course, lake, parks and grounds or for other purposes, may with the approval of the Declarant use the roads and street easements in the Subdivision.

#### Section 3.35 - Landscaping.

(a) Before any landscaping shall be commenced, the landscape layout, plans and itemized cost estimate shall first have been approved in writing by the Committee. Itemized cost estimates shall only be required for the original installation of landscaping. Such landscape layout and plans shall include all landscaping to be planted in the front, side and rear yards of the Lot at the time the dwelling is being completed and before occupancy. Thereafter, changes to the landscaping visible from any street, lake, golf course, common area or other lot shall be submitted for approval prior to installation.

(b) Unless otherwise approved by the Committee, at the time of initial construction of improvements on any Lot in the Subdivision, the Owner of each Lot shall spend not less than Five Thousand Dollars (\$5,000.00) for planting of grass, shrubbery and other landscaping work in the front, rear and side yards of such Lot; such grass, shrubbery and landscaping shall be maintained in a neat and attractive condition at all times.

(c) The Committee shall, in its sole discretion and authority, determine whether the landscape layout and plans, including, but not necessarily limited to, drainage, grass, shrub and tree planting, includes the proper amount of landscaping. The Committee may require additional or less landscaping should the Committee deem it to be necessary.

(d) Owners of Golf Estate Lots shall not grow or permit types of grasses or other vegetation to grow that, in the opinion of the Committee, is inimical to golf course grasses or vegetation, in the portion of the Golf Course Lots adjacent to the Golf Course. Such Owners may, however, with prior written approval of the Committee, install barriers that comply with these Restrictions and that will prevent the spread of otherwise prohibited grasses or vegetation into the Golf Course and, following the installation of such barriers, may grow such grasses or vegetation adjacent to the Golf Course.

Section 3.36 - Roofing. No external roofing material other than No. 1 Cedar wood shingles or not less than three hundred (300) pound composition shingles of a wood tone color, as approved by the Committee, shall be used on any residence or other improvement on any Lot without the prior written approval of the Committee.

Section 3.37 — Mailboxes. Mailboxes may not be constructed, installed or placed in the front of any residence. Only mailboxes installed or approved by the United States Postal Service and approved by the Committee shall be installed. Such approved mailboxes shall be installed in groups (having multiple individual mailboxes), which mailboxes shall provide mail service to residents who live in this Section and to residents who live outside of this Section. Such multiple mailboxes may be installed upon a concrete pad located within any utility easement (whether or not the easement is located upon a Lot so long as the mailboxes are not located in front of a house), located within any street right-of-way and/or located within any reserve. The Declarant or the Committee may, from time to time, construct concrete pads for the future location of approved mailboxes at any location described above and/or elsewhere in the Bentwater Subdivision and, in so doing, shall not be

liable to anyone for the construction of the concrete pad and subsequent installation of mailboxes. No Bentwater Property Owner, Bentwater resident or other person or persons shall have the right to make claims of injury or damages, bring causes of action, in any event, or file lawsuits to recover injury or damage against the Declarant or Committee or to cause the concrete pads and mailboxes to be removed.

Section 3.38 - Landing, Storage and Parking of Aircraft. No helicopters, hovercraft or other aircraft shall land or be stored or parked within the Subdivision, except in areas of the Subdivision or other areas designated by the Declarant until the "Transfer Date" (as hereinafter defined). From and after the Transfer Date, the Association may designate a portion of the Subdivision or other area, if any, for the landing, storage or parking of helicopters, hovercraft and other aircraft.

Section 3.39 - Storage of Materials and Equipment. No lawn tools wheelbarrows, lawn mowers or other lawn maintenance supplies or equipment and no other tools or devices used in maintenance, repair or construction of a residence and related facilities shall be stored or maintained on the Property except if located within an enclosed structure after the initial residence has been constructed and occupied. Except, however, when additions, remodeling or construction of improvements are being made, materials required for such construction can be stored on the Lot so long as such materials are neatly stacked for the duration of such construction. However, such storage shall be allowed only when continuous daily progress is being made to complete such additions, remodeling or construction.

Section 3.40 - Street Lighting. At the time a residence is built on any Lot, the Owner, at Owner's sole cost and expense, shall cause an ornamental light fixture mounted on a pole, as approved by the Committee, to be located on the Lot at a location approved by the Committee. The ornamental light pole shall be connected to the residence's electrical system and shall have a photo cell so the light is on during the hours of darkness. The Committee shall have the right, in its sole discretion, to exempt any residence from this requirement. Owner shall be required to keep this light fixture in good operating condition and appearance, at Owner's expense, including replacing light bulbs, painting and repair of light, the fixture and pole and including replacement thereof if necessary. Street lighting will not be installed by Declarant.

Section 3.41 - Lift Stations. If a lift station is indicated on the recorded plat for this section of Bentwater, Owners hereby agree to hold harmless the Declarant and the Association, and their successors and assigns and release them from any liability for the placement, construction, design, operation, maintenance and replacement of the lift station and agree to indemnify the parties released from any damages they may sustain.

Section 3.42 - Flagpoles. One flagpole may be maintained temporarily or permanently upon a home, so long as it is the type of flagpole customarily sold to be attached to a home. Flagpoles shall not exceed five (5) feet in length and must be maintained in good condition at all times.

Section 3.43 - Yard Art and Other Items. Yard art and other items including furnishings placed on a portion of a lot visible from any common area, lake, street, golf course or other lot shall be considered an improvement and requires prior approval as set out in Article IV herein.

#### **ARTICLE IV ARCHITECTURAL CONTROL COMMITTEE**

##### Section 4.01 - Basic Control.

(a) No building or other improvements of any character shall be erected or placed, or the erection or placing thereof commenced, or changes made in the design or exterior appearance thereof (including, without limitation, painting, staining or siding), or any addition or exterior alteration made thereto after original construction, or demolition or destruction by voluntary action made thereto after original construction, on any Lot in the Subdivision

until the obtaining of the necessary approval (as hereinafter provided) from the Architectural Control Committee ("the Committee") of the construction plans and specifications for the construction or alteration of such improvements or demolition or destruction of existing improvements by voluntary action. Approval shall be granted or withheld by the Committee based on matters of compliance with the provisions of this instrument, any architectural guidelines and bulletins, if any, and any other dedicatory instrument, quality and color of materials, drainage, harmony of external design and color with existing and proposed structures and location with respect to topography and finished grade elevation. The granting of approval shall in no way serve as a guaranty or warranty as to the quality of the plans or specifications nor the habitability, feasibility or quality of the resulting improvement.

(b) The sole authority for determining whether construction plans and specifications for proposed improvements are in compliance with the provisions of this Declaration as to quality and color of materials, drainage, harmony of external design and color with existing and proposed structures and location with respect to topography, finished grade elevations and other relevant factors, rests with the Committee. Disapproval of plans and specifications, including location of the proposed improvements, may be based by the Committee upon any grounds, including but not limited to purely aesthetic conditions, that shall seem sufficient in the sole discretion of the Committee.

(c) Each application made to the Committee shall be accompanied by three (3) sets of plans and specifications for all proposed construction (initial or alterations) to be done on such Lot, which must include an accurately drawn and dimensioned plot plan including all buildings, setbacks, easements, drives, walks, fences, storm water drainage, grading, etc. The plans must include a foundation plan and details, floor plan, exterior and interior elevations, wall sections, etc.; the plans must show design, construction and material. All foundation plans must be signed, sealed and dated by a licensed, registered professional engineer. Owner/Builder shall furnish to the Committee a copy of the soils report used in the design of the foundation and such report must be dated and have the legal description of the Lot. All other plans must be stamped and signed by a registered AIA architect or a licensed, registered, professional engineer. The address of the Committee shall be the address of the principal office of the Association.

(d) Architect. At the option of the Declarant and/or the Committee, the Declarant and/or the Committee may designate an architect to sit on the Committee who, together with the Committee, will have full authority to recommend the granting or denial of approval (as contemplated under Article IV hereunder) with respect to all structures erected, constructed or altered in the Subdivision.

The architect, together with the Committee, shall have the authority to require design changes in the Owner's structure in order to provide a harmonious development of the residences in the Subdivision and to insure that all residences constructed in the Subdivisions conform to the Declarant's and the Committee's predetermined plan for such improvements. A fee in an amount to be determined by the Committee shall be paid by the Owner to the Committee prior to architectural approval; a signed Architectural Approval Request letter must accompany each submission. Neither the Declarant nor the Committee shall in any way be responsible for the fee.

The Declarant or the Committee shall have the power, from time to time, to discharge any architect(s) who have been appointed and to appoint successors who shall succeed to all the authority of the architect previously serving.

Final approval of the plans and specifications shall be granted or withheld by the Committee based upon the architect's recommendation, if any, and other matters of compliance with this Declaration, not later than fifty (50) days after the Committee's receipt of the Owner's complete plans.



Section 4.02 - Architectural Control Committee.

(a) The authority to grant or withhold architectural control approval as referred to above is initially vested in the Declarant; provided, however, the authority of the Declarant shall cease and terminate upon the election of the Bentwater Architectural Control Committee (sometimes herein referred to as the "Committee"), in which event such authority shall be vested in and exercised by the Committee (as provided in (b) below), except as to plans and specifications and plot plans theretofore submitted to the Declarant, which shall continue to exercise such authority over all such plans, specifications and plot plans. The term "Committee," as used in this Declaration, shall mean or refer to the Declarant or to the Bentwater Architectural Control Committee composed of Owners, as applicable.

(b) At such time as all of the Lots in the Subdivision and in all other future sections of Bentwater (as currently or hereafter contemplated and subsequently platted, from time to time) and the entirety of the Annexable Area are owned by persons or entities other than the Declarant (which date is hereinafter referred to as the "Transfer Date"), the Declarant shall cause a statement of such circumstances to be placed of record in the Real Property Records of Montgomery County, Texas (which statement shall include the Transfer Date).

Thereupon, the Owners by vote, as hereinafter provided, shall elect a committee of three (3) members to be known as the Bentwater Architectural Control Committee. From and after the Transfer Date, each member of the Committee must be an Owner of property in some Section of Bentwater. Each Owner shall be entitled to one (1) vote for each whole Lot or building site owned by that Owner. In the case of any building site composed of more than one (1) whole Lot, such building site Owner shall be entitled to one (1) vote for each whole Lot contained within such building site.

The Declarant shall be obligated to arrange for the holding of such election within sixty (60) days following the filing of the aforesaid statement by the Declarant in the Real Property Records of Montgomery County, Texas, and to give notice of the time and place of such election (which shall be in Montgomery County, Texas) not less than thirty (30) days prior to the holding thereof. Nothing herein shall be interpreted to require that the Declarant actually file any such statement so long as it has not subdivided and sold the entirety of the Annexable Area nor affect the time at which the Declarant might take such action if in fact, the Declarant does take such action. Additionally, the Declarant shall have the right to discontinue the exercise of architectural control privileges and arrange for the election by the Owners at any time prior to the Transfer Date by filing a statement to such effect in the Real Property Records of Montgomery County, Texas.

(c) For the initial election, votes of the Owners shall be evidenced by written ballot furnished by the Declarant (and by the Board of Trustees, after the initial election). The Board of Trustees shall maintain said ballots as a permanent record of such election for a period of not less than three (3) years after such election. Any Owner may appoint a proxy to cast his or her ballot in such election, provided that the written appointment of such proxy is attached to the ballot as a part thereof. The Committee members initially elected by the Owners, as aforesaid, shall serve a two (2) year term. Thereafter, the Board of Trustees shall determine the length of the term of said Committee members, which in no event shall be less than one (1) year or more than two (2) years.

The result of each such election shall promptly be determined on the basis of a plurality vote of those Owners voting in such election. The results of any such election and of any removal or replacement of any member of the Committee may be evidenced by the recording of an appropriate instrument properly signed and acknowledged on behalf of the Declarant or by a majority of the Board of Trustees.

(d) After the first such election shall have been held, the Board of Trustees thereafter shall be obligated to arrange for elections (in the manner and after notice as set forth above), including elections requested in writing by fifty (50) or more Members to remove a member of the Committee. No member of the Committee may be removed except upon a majority

vote (voting in favor of removing said Committee member) of those voting in an election called by the Board of Trustees for said purpose.

(e) Upon the death, resignation, refusal or inability of any member of the Committee to serve on the Board of Trustees, by majority vote, shall fill the vacancy by appointment, and the person appointed shall complete the unexpired term of his or her predecessor.

(f) If the Board of Trustees should fail or refuse to take any action herein provided to be taken by the Board of Trustees with respect to setting elections, conducting elections, counting votes, determining results and evidencing such results, or naming successor Committee members, and such failure or refusal continues for a period that is unreasonably long (in the exclusive judgment of the Declarant), then the Declarant may validly perform such function.

(g) The members of the Committee shall be entitled to such compensation for services rendered and for reasonable expenses incurred as may, from time to time, be authorized or approved by the Association, and shall be entitled to retain architects, engineers and contractors on a fee basis to assist the Committee in reviewing plans and specifications and inspecting Lots and improvements. All such sums payable as compensation and/or reimbursement shall be payable only out of the "Maintenance Fund," as hereinafter defined.

Section 4.03 - Effect of Inaction. Approval or disapproval as to architectural control matters as set forth in the preceding provisions of this Declaration shall be in writing. In the event that the authority exercising the prerogative of approval or disapproval (whether the Declarant or the Committee) fails to approve or disapprove in writing any plans, specifications and plot plans received by it in compliance with the preceding provisions within fifty (50) days following such submission, such plans, specifications and plot plans shall be deemed approved and the construction of any such building and other improvements may be commenced and proceeded with in compliance with all such plans and specifications and plot plan and all of the other terms and provisions hereof.

Section 4.04 - Effect of Approval. The granting of the aforesaid approval (whether in writing or by lapse of time) shall constitute only an expression of opinion by the Committee that the terms and provisions of this Declaration shall be complied with if the building and/or other improvements are erected in accordance with said plans, specifications and plot plan: Such approval shall not constitute any nature of waiver or estoppel either as to the persons expressing such approval or any other person in the event that such building and/or improvements are not constructed in accordance with such plans and specifications and plot plan or in the event that such building and/or improvements are constructed in accordance with such plans and specifications and plot plan, but nevertheless, fail to comply with the provisions of this Declaration. Further, no person exercising any prerogative of approval or disapproval shall incur any liability by reason of the good faith exercise thereof. Exercise of any such prerogative by one (1) or more members of the Committee in their capacity as such shall not constitute action by the Declarant after the election of such Committee members, notwithstanding that any such Committee member may be an officer, owner or director of Declarant.

Section 4.05 - Inspection. A ten (10) year or more warranty from a reputable, warranty company must be obtained before a Certificate of Completion, which may be required under any building guidelines or approval procedures promulgated for the Property, may be submitted. The selection of such home warranty company in regards to reputation and financial solvency shall be left to the absolute discretion of Builder or Owner. **Furthermore, the Committee strongly suggests that Owners and Builders have frequent inspections made, or require their Contractors to have inspections made, in order to control the quality of the improvement being constructed. However, neither the Association, the Committee nor the Declarant is responsible for procuring such inspections and will not be liable for any damage that may occur as a result of such inspections not being done or being done improperly.**

Section 4.06 - Variances. The Committee may authorize variances from compliance with any of the provisions of this Declaration, including without limitation, building setback lines or minimum acceptable construction standards or regulations and requirements as



promulgated from time to time by the Committee, when circumstances such as topography, natural obstructions, Lot configuration, Lot size, hardship, aesthetic, environmental or technological advancements considerations may require a variance. The Declarant and/or Committee reserve the right to grant variances as to building setback lines and other items for a house to be constructed on Block 1, Lot One (1) for any reason in its or their sole and absolute discretion without liability to any Owner or other person for approving such variances. Such variances must be evidenced in writing and shall become effective when signed by the Declarant or by at least a majority of the members of the Committee. If any such variances are granted, no violation of the provisions of this Declaration shall be deemed to have occurred with respect to the matter for which the variance is granted. However, the granting of a variance shall not operate to waive any of the provisions of this Declaration for any purpose except as to the particular property and particular provisions hereof covered by the variance, nor shall the granting of any variance affect in any way the Owner's obligation to comply with all governmental laws and regulations affecting the property concerned and the Plat (except to the extent that the variance relates to building setback lines). As more particularly described in Section 4.10, neither the Declarant nor the Committee shall be liable to any Owner or any other person for approving or disapproving a request for a variance.

Section 4.07 - Notices of Completion and Noncompliance. Each Owner shall send a written notice of the completion ("Notice of Completion") of such Owner's construction of residential improvements to the Committee and to the Association within fifteen (15) days after completion of such Owner's construction. If the Committee finds that any residential construction has been done without obtaining the approval of the Committee or was not done in conformity with the approved plans and specifications and plot plan, the Committee shall notify the Owner in writing of the noncompliance, which notice ("Notice of Noncompliance") shall be given, in any event, within sixty (60) days after the Committee receives a Notice of Completion. The Notice of Non-Compliance shall specify the particulars of the noncompliance and shall require the Owner to take such action as may be necessary to remedy the noncompliance. If, for any reason other than Owner's negligent acts or omissions or willful misconduct, the Committee fails to notify the Owner of any noncompliance within sixty (60) days after receipt by the Committee and the Association of the Notice of Completion, the improvements constructed by such Owner on the Lot shall be deemed in compliance if such improvements were, in fact, completed as of the date of the Notice of Completion. If, however, the Committee issues a Notice of Noncompliance, the Owner shall commence to correct the noncompliance without delay. If the Owner does not correct the noncompliance within forty-five (45) days after receipt of the Notice of Noncompliance or commence, within ten (10) days after receipt of the Notice of Noncompliance, the correction of such noncompliance in the case of a noncompliance that cannot reasonably be expected to be corrected within forty-five (45) days (provided that such Owner diligently continues the removal of such noncompliance), the Board of Trustees may, at its option, (i) record a Notice of Noncompliance against the Lot on which the noncompliance exists, and/or (ii) may otherwise correct such noncompliance, and the Owner shall reimburse the Association, upon demand, for all expenses incurred therewith, which reimbursement obligation shall be a charge on such Owner's Lot and shall be a continuing lien (secured by the same lien that secures the Maintenance Charge). The right of the Board of Trustees to remedy or remove any noncompliance shall be in addition to all other rights and remedies that the Board of Trustees may have at law, in equity, or under this Declaration to cure such noncompliance.

Section 4.08 - No Implied Waiver of Estoppel. No action or failure to act by the Committee or by the Board of Trustees shall constitute a waiver or estoppel with respect to future action by the Committee or Board of Trustees with respect to the construction of any improvements within the Subdivision. Specifically, the approval by the Committee or Board of Trustees of any such residential construction shall not be deemed a waiver of any right or an estoppel to withhold approval or consent for any similar residential construction or any similar proposals, plans, specifications or other materials submitted with respect to any other residential construction by such person or other Owners.

Section 4.09 - Disclaimer. No approval of plans and specifications and no publication or designation or architectural standards or rules and regulations shall ever be construed as

representing or implying that such plans, specifications or standards will result in a properly designed structure or satisfy any legal requirements.

Section 4.10 - Non-Liability for Committee Action. Except for bad faith or willful misconduct, neither the Declarant, the Committee, the Architect, the Association, nor any member of the Board of Directors shall be liable to any Owner or any other person for any loss, damage or injury arising out of or in any way connected with any actions or failure to act or in connection with any approval or disapproval of plans and specifications or any approval or disapproval of any request for a variance, including, without limitation, mistakes in judgment, negligence, malfeasance or nonfeasance. No approval of plans and specifications and no publication of minimum construction standards or rules and regulations shall ever be construed as representing or implying that, or as a warranty or guaranty that, if followed, the improvements or modifications of the improvements will comply with applicable building codes, legal requirements or other governmental laws or regulations, or as to any other matters relating to the health, safety, workmanship or suitability for any purpose. The Committee is not liable to any Owner for any impairment of view as a result of the construction of any improvements upon another Lot, built or to be constructed pursuant to plans approved by the Committee.

## **ARTICLE V BENTWATER PROPERTY OWNERS ASSOCIATION INC.**

Section 5.01 - Membership. Every person or entity who is a record Owner of any Lot that is subject to the Maintenance Charge (or could be following the withdrawal of an exemption therefrom) and other assessments provided herein, including contract sellers, shall be a "Member" of the Association. The foregoing is not intended to include persons or entities who hold an interest merely as security for the performance of an obligation or those having only an interest in the mineral estate. No Owner shall have more than one membership for each Lot owned by such Member. Memberships shall be appurtenant to and may not be separated from the ownership of the Lots. Regardless of the number of persons who may own a Lot (such as husband and wife or joint tenants, etc.), there shall be but one membership for each Lot. Additionally, the initial Trustees' of the Association (and said initial Trustees' successors) shall also be Members of the Association (as more particularly described in the By-Laws). Other than said initial Trustees, ownership of the Lots shall be the sole qualification for membership. The voting rights of the Members are set forth in the By-Laws of the Association.

Section 5.02 - Non-Profit Corporation. Bentwater Property Owners Association, Inc., a non-profit corporation, has been organized and it shall be governed by the Articles of Incorporation and By-Laws of said Association; all duties, obligations, benefits, liens and rights hereunder in favor of the Association shall vest in said non-profit corporation.

Section 5.03 - By-Laws. The Association may adopt whatever By-Laws it may choose to govern the organization or operation of the Subdivision and the use and enjoyment of the Lots and Common Areas, provided that the same are not in conflict with the terms and provisions hereof.

Section 5.04 - Members' Rights of Enjoyment. Every Member shall have a beneficial interest of use and enjoyment in and to the Common Areas and such right shall be appurtenant to and shall pass with the title to every assessed Lot, subject to the following provisions:

- (a) the right of the Association, with respect to the Common Areas, to limit the number of guests of Members;
- (b) the right of the Association to charge reasonable admission and other fees for the use of any facility situated upon the Common Area;
- (c) the right of the Association, in accordance with its Articles and By-Laws (and subject to the prior written approval of the Declarant), to (i) borrow money for the purpose of improving and maintaining the streets and roads within the Subdivision, Lakes, Common Area and facilities (including borrowing from the Declarant or any entity affiliated with the

Declarant) and (ii) mortgage the Property; however, the rights of such mortgagee of said Property shall be subordinate to the rights of the Owners hereunder;

(d) the right of the Association to suspend a Member's voting rights and the Member's and any Related User's (as defined below) right to use any recreational facilities within the Common Areas during any period in which the Maintenance Charge or any assessment against his or her Lot remains unpaid;

(e) the right of the Association to suspend the Member's voting rights and the Member's and Related User's right to use any recreational facilities within the Common Area, after notice and hearing by the Board of Trustees, for the infraction or violation by such Member or Related User of this Declaration or the "Rules and Regulations," as hereinafter discussed, which suspension shall continue for the duration of such infraction or violation, plus a period not to exceed sixty (60) days following the cessation or curing of such infraction or violation; and

(f) the right of the Association, subject to the prior written approval of the Declarant, to dedicate or transfer all or any part of the Common Area to any public agency, authority or utility, for such purposes and subject to the provisions of Section 8.22.

Section 5.05 — Delegation of Use. Any Member may delegate, in accordance with the By-Laws, his or her right of enjoyment to the Common Area and facilities to the members of his or her immediate family living in the Member's residence, his or her tenants or contract purchasers who reside on the Property (collectively, the "Related Users"). If a Member leases his or her Lot to a tenant or sells his or her Lot to a contract purchaser, the tenant or contract purchaser, but not the Member, shall have the exclusive privilege of enjoyment of the Common Area and facilities of the Association during the term of said tenant's tenancy.

Section 5.06 - Rental and Leasing. Owners must notify the Association if their Lots are leased. Owners must also provide the Association with the name of the tenant, a copy of the lease and the current mailing address of the Owner of the Lot. In no event, however, shall any leasing be allowed except pursuant to a written agreement or form approved by the Board of Trustees that affirmatively obligates all tenants and other residents of the Lot to abide by this Declaration, the By-Laws, and the Rules and Regulations of the Association.

## **ARTICLE VI MAINTENANCE FUND**

Section 6.01 - Maintenance Fund Obligation. Each Owner of a Lot by acceptance of a deed therefore, whether or not it shall be expressed in any such deed or other conveyance, is deemed to covenant and agrees to pay to the Association a general maintenance charge (the "Maintenance Charge"), the "BYCC Charge" (as hereinafter defined), and any other assessments or charges hereby levied. The Maintenance Charge, BYCC Charge, and any other assessments or charges hereby levied, together with such interest thereon and costs of collection thereof, as hereinafter provided, shall be a charge on the Lots and shall be a continuing lien upon the property against which the Maintenance Charge and other such charges and assessments are made.

### Section 6.02 - Basis of the Maintenance Charge.

(a) The Maintenance Charge shall be used to create a fund to be known as the "Maintenance Fund," which shall be used as herein provided, and each such Maintenance Charge (except as otherwise herein provided) shall be paid by the Owner of each Lot (or residential building site) to the Association annually, in advance. The Board of Trustees shall designate the due date(s) of the Maintenance Charge from time to time by written notice to the Owner, which notice may consist of a statement for the Maintenance Charge, or on such other basis (monthly, quarterly or semi-annually) as the Board of Trustees may designate in its sole discretion. The Maintenance Charge payable during the first year of an Owner's

ownership of a Lot shall be prorated and be payable at the closing of said Owner's purchase of the Lot, or when invoiced by the Association.

(b) Any Maintenance Charge or BYCC Charge not paid within thirty (30) days after the due date shall bear interest from the due date at the lesser of (i) the rate of eighteen percent (18%) per annum or (ii) the maximum rate permitted by law. The Association may bring an action at law against the Owner personally obligated to pay the same, or foreclose the hereinafter described lien against the Owner's Lot and then file suit to collect any deficiency. No Owner may waive or otherwise escape liability for the Maintenance Charge or any other charge or assessment by non-use of any Common Areas or recreational facilities available for use by Owners of the Subdivision or by the abandonment of his or her Lot.

(c) The exact amount of the Maintenance Charge applicable to each Lot will be determined by the Board of Trustees not less than a month preceding the due date of the Maintenance Charge. All other matters relating to the Maintenance Charge and the collection, expenditure and administration of the Maintenance Fund shall be determined by the Board of Trustees, subject to the provisions hereof.

(d) The Maintenance Charge will include a monthly charge for street lighting in the Common Areas of the Subdivision. Such charge will be included in the Association's monthly bill for electric services from Entergy/Gulf States Utilities Company (or successor company supplying electric service) and shall be in addition to all other charges that such Owner may directly incur for residential electric service. The exact amount of the street lighting charge will be determined (and adjusted from time to time) by Entergy/Gulf States Utilities Company (or a successor company supplying electric service).

(e) In addition to the Maintenance Charge, each Lot shall also be subject to a monthly utility charge payable directly to the Utility District, commencing on the first day of the first calendar month following the month in which a water line and a sanitary sewer line are extended by the Utility District to a property line of the subject Lot and terminating upon the completion of the construction of a residence on such Lot and the connection of such residence to such water line and sanitary sewer line and the payment by the Owner of all necessary tap or connection fees.

The amount of the utility charge shall be determined by the Utility District and shall be payable monthly, quarterly, semi-annually or annually, as determined by the entity collecting said utility charge. However, the utility charge shall be subject to a pro rata rebate in the event that a residence is completed during such year. Payment of the aforesaid utility charge is and shall be secured by the same lien that secures the Maintenance Charge, which lien shall be assigned by the Association to the Utility District.

(f) Each Owner of a Lot, other than Declarant, has agreed to obtain and maintain a "Social Membership" (as defined in the Rules and Regulations of the Bentwater Yacht & Country Club operated by BYCC) during the term of said Owner's ownership of a Lot. Said Social Membership in the Bentwater Yacht & Country Club shall be transferred to the successor Owner of an Owner's Lot in accordance with the Rules and Regulations of the Bentwater Yacht & Country Club. Each Owner may also obtain a membership ("BYCC Membership") in the Bentwater Yacht & Country Club providing membership privileges in addition to the Social Membership, which Bentwater Yacht & Country Club Memberships are currently classified as Country Club Memberships, Golf Club Memberships, Sports Club Memberships and Senior Memberships, in accordance with and as described in the Rules and Regulations of the Bentwater Yacht & Country Club. A transfer of said Bentwater Yacht & Country Club Membership or upon the sale of an Owner's Lot shall be subject to the Rules and Regulations of the Bentwater Yacht & Country Club. Each Owner of a Lot, by acceptance of the deed therefor, whether or not it shall be expressed in any such deed or other conveyance, is deemed to covenant and agree to pay directly to BYCC, unless otherwise directed by the Declarant, a monthly social membership charge and other charge, if any ("BYCC Charge") related to such Owner's additional Bentwater Yacht & Country Club membership. The BYCC Charge, together with such interest thereon and costs of collection thereof, as provided for in the Rules and Regulations of the Bentwater Yacht & Country

Club, shall be a charge on the Lots and shall be a continuing lien as to the BYCC Charge (a purchase money lien secured by the same lien which secures the Maintenance Charge), which lien as to the BYCC Charge shall be assigned by the Association to the BYCC upon the Lots against which each such BYCC Charge is made. Each Owner's right to use the facilities of the Bentwater Yacht & Country Club shall be governed by the Rules and Regulations of the Bentwater Yacht & Country Club (and not by the Association). The BYCC Charge may be payable monthly, quarterly or semi-annually, instead of annually, as determined by the BYCC by written notice thereof to the Owner.

(g) The Maintenance Charge described in this Article VI, BYCC Charge, Utility Charge and other charges or assessments described in this Declaration shall not, without the consent of the Declarant, apply to the Lots owned by the Declarant. The Declarant, prior to the Transfer Date, and the Association, from and after the Transfer Date, reserve the right at all times, in their own judgment and discretion, to exempt any Lot ("Exempt Lot") in the Subdivision from the Maintenance Charge, including, without limitation, Lots owned by Builders. The exercise of such judgment and discretion when made in good faith shall be binding and conclusive on all persons and interests. If an Exempt Lot is sold to any party, the Maintenance Charge shall automatically be reinstated as to the Exempt Lot and can only be waived at a later date pursuant to the provisions of the preceding sentence. The Declarant, prior to the Transfer Date, and the Association, from and after the Transfer Date, shall have the further right at any time, and from time to time, to adjust or alter said Maintenance Charge from month to month as it deems proper to meet the reasonable operating expenses and reserve requirements of the Association in order for the Association to carry out its duties hereunder.

Section 6.03 - Creation of Lien and Personal Obligation. In order to secure the payment of the Maintenance Charge, BYCC Charge, Utility Charge and other charges and assessments hereby levied, a maintenance assessment lien for the benefit of the Association, shall be and is hereby reserved in the deed from the Declarant to the purchaser of each Lot or portion thereof, which lien shall be enforceable through appropriate judicial and nonjudicial proceedings by the Association. As additional security for the payment of the Maintenance Charge, BYCC Charge and other charges and assessments hereby levied, each Owner of a Lot in the Subdivision, by such party's acceptance of a deed thereto, hereby grants the Association a contractual lien on such Lot, which lien may be foreclosed on by nonjudicial foreclosure and pursuant to the provisions of Section 51.002 of the Texas Property Code (and any successor statute), and each such Owner hereby expressly grants the Association a power of sale in connection therewith. The Association shall, whenever it proceeds with nonjudicial foreclosure pursuant to the provisions of said Section 51.002 of the Texas Property Code and said power of sale, designate in writing a Trustee to post or cause to be posted all required notices of such foreclosure sale and to conduct such foreclosure sale. The Trustee may be changed at any time and from time to time by the Association by means of a written instrument executed by the President or any Vice President of the Association and filed for record in the Real Property Records of Montgomery County, Texas. The Association shall have the right to bid on and purchase such foreclosed upon Lot at such foreclosure sale.

In the event that the Association has determined to non-judicially foreclose the lien provided herein pursuant to the provisions of said Section 51.002 of the Texas Property Code and to exercise the power of sale hereby granted, the Association shall mail to the defaulting Owner a copy of the Notice of Trustee's Sale not less than twenty-one (21) days prior to the date on which said sale is scheduled by posting such notice through the U.S. Postal Service, postage prepaid, certified, return receipt requested, properly addressed to such Owner at the last known address of such Owner according to the records of the Association. If required by law, the Association or Trustee shall send any curative period notice to the Owner and also cause a copy of the Notice of Trustee's Sale to be recorded in the Real Property Records of Montgomery County, Texas. Out of the proceeds of such sale, if any, there shall first be paid all expenses incurred by the Association in connection with such default, including but not limited to reasonable attorney's fees and a reasonable trustees fee; second, from such proceeds there shall be paid to the Association an amount equal to the amount in default; and, third, the remaining balance shall be paid to such Owner. Following any such foreclosure,

each occupant of any such Lot foreclosed on and each occupant of any improvements thereon shall be deemed to be a tenant at sufferance and may be removed from possession by any and all lawful means, including a judgment for possession in an action of forcible detainer and the issuance of a writ of restitution thereunder.

In the event of nonpayment by any Owner of any Maintenance Charge, BYCC Charge, Utility Charge or other charge or assessment levied hereunder, the Association may, in addition to foreclosing the lien hereby retained and exercising the remedies provided herein, upon thirty (30) days prior written notice thereof to such nonpaying Owner, exercise all other rights and remedies available at law or in equity.

It is the intent of the provisions of this Section 6.03 to comply with the provisions of said Section 51.002 of the Texas Property Code relating to nonjudicial sales by power of sale and, in the event of the amendment of said Section 51.002 of the Texas Property Code hereafter, the President or any Vice President of the Association, acting without joinder of any other Owner, mortgagee or other person may, by amendment to this Declaration filed in the Real Property Records of Montgomery County, Texas, amend the provisions hereof so as to comply with said amendments to Section 51.002 of the Texas Property Code.

As provided above, the Association shall have the right to assign the lien described in Article VI securing the payment of the BYCC Charge, Utility Charge, and other charges and assessments to: (i) the Bentwater Yacht and Country Club (in case of said BYCC Charge), (ii) the Utility District (in the case of the said Utility Charge), and (iii) the other applicable entities collecting said other charges and assessments. The assignment of said liens shall be evidenced in writing and filed for record in the Real Property Records of Montgomery County, Texas. Upon the recordation of said assignment instrument(s), the assignee designated in said assignment instrument shall be entitled to exercise the same rights with respect to said entity's collection of the charge or assessment that is payable directly to said entity as the Association may exercise hereunder with respect to its collection of the Maintenance Charge.

Section 6.04 - Notice of Lien. In addition to the right of the Association to enforce the Maintenance Charge or other charge or assessment levied hereunder, the Association may file a claim or lien against the Lot of the delinquent Owner by recording a notice setting forth (a) the amount of the claim of delinquency, (b) the interest and costs of collection that have accrued thereon, (c) the legal description and street address of the Lot against which the Lien is claimed and (d) the name of the Owner thereof ("Notice of Lien"). Such Notice of Lien shall be signed and acknowledged by an officer of the Association or other duly authorized agent of the Association. The lien shall continue until the amounts secured thereby and all subsequently accruing amounts are fully paid or otherwise satisfied. When all amounts claimed under the Notice of Lien and all other costs and assessments that may have accrued subsequent to the filing of the Notice of Lien have been fully paid or satisfied, the Association shall execute and record a notice releasing the lien upon payment by the Owner of a reasonable fee as fixed by the Board of Trustees to cover the preparation and recordation of such release of lien instrument. The Bentwater Yacht and Country Club (in the case of the BYCC Charge), the Utility District (in the case of the Utility District Charge) shall each have the right to record a Notice of Lien in the event of the delinquency by an Owner in the payment of applicable charges or assessments in the same manner as the Association may file a Notice of Lien with respect to the Maintenance Charge, which Notice of Lien shall be governed by the provisions of this Section 6.04.

Section 6.05 - Liens Subordinate to Mortgages. The liens described in Section 6.03 hereof and the superior title herein reserved shall be deemed subordinate to a first lien or other liens of any bank, insurance company, savings and loan association, university, pension and profit sharing trusts or plans, or other bona fide, third-party lender, including Declarant, that may have heretofore or may hereafter lend money in good faith for the purchase or improvement of any Lot and any renewal, extension, rearrangement or refinancing thereof. Each such mortgagee of a mortgage encumbering a Lot who obtains title to such Lot pursuant to the remedies provided in the deed of trust or mortgage or by judicial foreclosure shall take title to the Lot free and clear of any claims for unpaid Maintenance Charges or other charges



or assessments against such Lot that accrued prior to the time such holder acquires title to such Lot. No such sale or transfer shall relieve such holder acquiring title to a Lot from liability for any Maintenance Charge or other charges or assessments thereafter becoming due or from the lien thereof. Any other sale or transfer of a Lot shall not affect the Association's lien for Maintenance Charges or other charges or assessments. The Association shall make a good faith effort to give each such mortgagee sixty (60) days advance written notice of the Association's proposed foreclosure of the lien described in Section 6.01 hereof, which notice shall be sent to the nearest office of such mortgage by prepaid, U.S. registered or certified mail, return receipt requested, and shall contain a statement of delinquent Maintenance Charges or other charges or assessments upon which the proposed action is based and any other costs or legal fees that have accrued; provided, however, the Association's failure to give such notice shall not impair or invalidate any foreclosure conducted by the Association pursuant to the provisions of this Article VI.

Section 6.06 - Purpose of the Maintenance Charge. The Maintenance Charge levied by the Association shall be used exclusively for the purpose of enforcing the Declaration and other dedicatory instruments and to promote the betterment of the Property and the welfare of the Owners of the Subdivision and other portions of the Annexable Area that hereafter may become subject to the jurisdiction of the Association. In particular, the Maintenance Charge shall be used for any improvement or services in furtherance of these purposes and the performance of the Association's duties described in Article VIII, including the maintenance of the Common Areas (including, without limitation, the privately owned roads and streets) and the establishment and maintenance of a reserve fund for maintenance of the Common Areas. The Maintenance Fund may be expended by the Association for any purposes that, in the judgment of the Association, will tend to maintain the property values in the Subdivision, including, but not limited to, providing funds for the actual cost to the Association of all taxes, insurance, repairs, energy charges, replacement and maintenance of the Common Areas as may from time to time be authorized by the Board of Trustees, and other facilities, services and activities as may from time to time be authorized by the Board of Trustees, including, but not limited to, construction, maintenance and operation of an administration and/or maintenance building(s), salaries of personnel and fees paid to independent contractors, mowing of grass and weeds within the Subdivision and maintaining and caring for the Common Areas (as more Particularly described in Article VIII), renting or purchasing of any equipment needed to perform the duties of the Association and maintenance or replacement of such equipment, the operation, maintenance, repair and replacement of parks, recreational grounds and equipment and improvements, payment of all legal and other expenses incurred in connection with the enforcement of this Declaration, the Rules and Regulations and all other dedicatory instruments, payment of all reasonable and necessary expenses in connection with the collection and administration of the Maintenance Charge and other charges and assessments required by this Declaration or that the Board of Trustees shall determine to be necessary to meet the primary purposes of the Association. Except for the Association's use of the Maintenance Charge to perform its duties described in this Declaration and in the By-Laws, the use of the Maintenance Charge for any of these purposes is permissive and not mandatory. It is understood that the judgment of the Association as to the expenditure of said funds shall be final and conclusive so long as such judgment is exercised in good faith.

Section 6.07 - Exempt Property. The following property subject to this Declaration shall be exempt from the Maintenance Charge and all other charges and assessments created herein: (a) all properties dedicated to and accepted by a local public authority; (b) the Common Area; and (c) all properties owned by a charitable or non-profit organization exempt from taxation by the laws of the State of Texas; however, no land or improvements devoted to dwelling use shall be exempt from said Maintenance Charge, except as otherwise provided in Section 6.02.

## **ARTICLE VII DECLARANT'S RIGHTS AND RESERVATIONS**

Section 7.01 - Period of Declarant Rights and Reservations. Declarant shall have, retain and reserve certain rights as hereinafter set forth with respect to the Association and the Common Area from the date hereof, until the earlier to occur of (i) the Transfer Date or

(ii) Declarant's written notice to the Association of Declarant's termination of the rights described in Article VII hereof. The rights and reservations hereinafter set forth shall be deemed excepted and reserved in each conveyance of a Lot by Declarant to an Owner whether or not specifically stated therein and in each deed or other instrument by which any Property within the Common Area is conveyed by Declarant. The rights, reservations and easements hereinafter set forth shall be prior and superior to any other provisions of this Declaration and may not, without Declarant's prior written consent, be modified, amended, rescinded or affected by any amendment of this Declaration. Declarant's consent to any one such amendment shall not be construed as a consent to any other or subsequent amendment. Nothing in Article VII of this Declaration shall limit or impair the reserved rights of Declarant as elsewhere provided in this Declaration.

Section 7.02 - Right to Construct Additional Improvements in Common Area. Declarant shall have and hereby reserves the right (without the consent of any other Owner), but shall not be obligated, to construct additional improvements within the Common Area at any time and from time to time in accordance with this Declaration for the improvement and enhancement thereof and for the benefit of the Association and Owners, so long as such construction does not directly result in the increase of the Maintenance Charge. Declarant shall convey or transfer such improvements to the Association and the Association shall be obligated to accept title to, care for and maintain the same as elsewhere provided in this Declaration.

Section 7.03 - Declarant's Right to Use Common Areas in Promotion and Marketing of the Property and Annexable Area. Declarant shall have and hereby reserves the right to reasonable use of the Common Area and of services offered by the Association in connection with the promotion and marketing of land within the boundaries of the Property and Annexable Area. Without limiting the generality of the foregoing, Declarant may erect and maintain on any part of the Common Area such signs, temporary buildings and other structures as Declarant may reasonably deem necessary or proper in connection with the promotion, development and marketing of land within the Property and Annexable Area; may use vehicles and equipment within the Common Area for promotional purposes; and may permit prospective purchasers of property within the boundaries of the Property and Annexable Area who are not Owners or Members of the Association to use the Common Area at reasonable times and in reasonable numbers; and may refer to the services offered by the Association in connection with the development, promotion and marketing of the Property and Annexable Area.

Section 7.04 - Declarant Rights to Complete Development of the Subdivision. No provision of this Declaration shall be construed to prevent or limit Declarant right (or require Declarant to obtain any approval) to (i) complete development of the real property within the boundaries of the Property and Annexable Area; (ii) construct, alter, demolish or replace improvements on any real property owned by Declarant within the Property or Annexable Area; (iii) maintain model homes, storage areas, offices for construction, initial sales, resales or leasing purposes or similar facilities on any property owned by Declarant or owned by the Association within the Property; (iv) post signs incidental to development, construction, promotion, marketing, sales or leasing of property within the Property and Annexable Area; (v) excavate, cut, fill or grade any property owned by Declarant; or (vi) require Declarant to seek or obtain the approval of the Committee or of the Association for any such activity or improvement to property by Declarant on any property owned by Declarant.

Section 7.05 - Declarant Rights to Grant and Create Easements. Declarant shall have and hereby reserves the right, without the consent of any other Owner or the Association, to grant or create temporary or permanent easements for access, utilities, pipeline easements, cable television systems, communication and alarm or protection systems, drainage, water and other purposes incidental to development, sale, operation and maintenance of the Subdivision, located in, on, under, over and across (i) all property, including Lots, owned by Declarant, (ii) the Common Area, and (iii) existing utility easements. Declarant also reserves the right, without the consent of the joinder of the Association or any Owner of a Lot acquired from Declarant or from any other party, to grant or create temporary or permanent easements for access or the installation of utilities (including, without limitation, sanitary sewer, water lines,



storm drainage [surface or underground], electrical lines and telephone lines), cable television systems, and communication and alarm or protection systems, over, under and across any Lot so long as such granted easement is located within the area between the Lot property lines and the building setback lines established by the recorded Plat or this Declaration. Declarant also reserves the right, without the consent of any other Owner or the Association, to (i) grant or create temporary or permanent easements for access over and across the streets and roads within the Subdivision to and from F.M. 1097 for the benefit of Owners of property within the Annexable Area or Owners of any other property, regardless of whether the beneficiary of such easements owns property that is hereafter made subject to the jurisdiction of the Association and (ii) permit Owners of property within the Annexable Area that is not made subject to the jurisdiction of the Association to use the recreational facilities of the Association and other Common Areas, including the Lakes, provided that said Owners pay to the Association their proportionate share of the cost of operating and maintaining said recreational facilities and Common Areas.

Section 7.06 - Declarant's Rights to Convey Additional Common Area to the Association. Declarant shall have and hereby reserves the right, but not the obligation to convey additional real property and improvements thereon, if any, to the Association as Common Area at any time and from time to time in accordance with this Declaration, without the consent of any other Owner or the Association.

Section 7.07 - Annexation of Annexable Area. Additional residential property and areas outside of the Subdivision including, without limitation, the Annexable Area, may, at any time and from time to time, be annexed by the Declarant into the real property that becomes subject to the jurisdiction and benefit of the Association, without the consent of the Owners or any other party; provided, however, such additional residential property outside of the Annexable Area may be made subject to the jurisdiction of the Association by the Declarant, without the consent of the Owners or any other party, provided that the annexation is in accordance with a general plan theretofore approved by the Board of Trustees. The Owners of Lots in such annexed property, as well as all other Owners subject to the jurisdiction of the Association, shall be entitled to the use and benefit of all Common Areas that are or may become subject to the jurisdiction of the Association, provided that such annexed property is impressed with and subject to at least the Maintenance Charge imposed hereby.

## **ARTICLE VIII DUTIES AND POWERS OF THE PROPERTY OWNERS ASSOCIATION**

Section 8.01 - General Duties and Powers of the Association. The Association has been formed to further the common interests of the Members. The Association, acting through the Board of Trustees or through persons to whom the Board of Trustees has delegated such powers (and subject to the provisions of the By-Laws), shall have the duties and powers hereinafter set forth and, in general, the power to do anything that may be necessary or desirable to further the common interests of the Members, to maintain, improve and enhance the Common Areas and to improve and enhance the attractiveness and desirability of the Subdivision and any portion of the Annexable Area that becomes subject to the jurisdiction of the Association. The Association shall have the authority to act as the agent and attorney-in-fact for all Members of the Association and to enter into any and all contracts on behalf of the Members in order to carry out the duties, powers and obligations of the Association as set forth in this Declaration.

Section 8.02 - Duty to Accept the Property and Facilities Transferred by Declarant. The Association shall accept title to any property, including any improvements thereon and personal property transferred to the Association by Declarant, and equipment related thereto, together with the responsibility to perform any and all administrative functions and recreation functions associated therewith (collectively herein referred to as "Functions"), provided that such property and Functions are not inconsistent with the terms of this Declaration. Property interests transferred to the Association by Declarant may include fee simple title, easements, leasehold interests and licenses to use such property. Any property or interest in property transferred to the Association by Declarant shall be within the boundaries of the Property or

Annexable Area. Any property or interest in property transferred to the Association by Declarant shall, except to the extent otherwise specifically approved by resolution of the Board of Trustees, be transferred to the Association free and clear of all liens and mortgages (other than the lien for property taxes and assessments not then due and payable), but shall be subject to the terms of this Declaration, the terms of any declaration of covenants, conditions and restrictions annexing such property to the Common Area, any amendments to either and all easements, covenants, conditions, restrictions and equitable servitudes or other encumbrances that do not materially affect the use and enjoyment of such property by the Association or by the Owners authorized to use such property.

Except as otherwise specifically approved by resolution of the Board of Trustees, no property or interest in property transferred to the Association by the Declarant shall impose upon the Association any obligation to make monetary payments to Declarant or any affiliate of Declarant including, but not limited to, any purchase price, rent, charge or fee. The property or interest in property transferred to the Association by Declarant shall not impose any unreasonable or special burdens of ownership of property, including the management maintenance replacement and operation thereof.

Section 8.03 - Duty to Manage and Care for the Common Area. The Association shall manage, operate, care for, maintain and repair all Common Areas and keep the same in a safe, attractive and desirable condition for the use and enjoyment of the Members. The duty to operate, manage and maintain the Common Areas may include, but not be limited to, the following: establishment, operation and maintenance of a patrol, alarm monitoring and/or alarm system for the Subdivision; landscaping, maintenance, repair and replacement of the privately owned roads and streets (including the installation and maintenance of a sprinkler system); maintenance, repair and replacement of the privately owned roads and streets, roadside ditches and culverts, culvert pipes underneath streets, bridges, traffic control improvements (traffic signals and street lights); and mowing of street right-of-ways and other portions of the Subdivision.

Section 8.04 - Duty to Pay Taxes. The Association shall pay all taxes and assessments levied upon the Common Areas and shall have the right to contest any such taxes or assessments provided that (i) the Association shall contest the same by appropriate legal proceedings that shall have the effect of preventing the collection of the tax or assessment, and the sale or foreclosure of any lien for such tax or assessment, and (ii) provided that the Association shall keep and hold sufficient funds to pay and discharge the taxes and assessments, together with any interest and penalties that may accrue with respect thereto, if the contest of such taxes is unsuccessful.

Section 8.05 - Duty to Maintain Casualty Insurance. The Association shall obtain and keep in full force and effect at all times, to the extent reasonably obtainable, casualty, fire and extended coverage insurance with respect to all insurable improvements and personal property owned by the Association including coverage for vandalism and malicious mischief and, if available and if deemed appropriate, coverage for flood, earthquake and war risk. Casualty, fire and extended coverage insurance with respect to insurable improvements shall, to the extent reasonably obtainable, be for the full insurable value based on current replacement cost.

Section 8.06 - Disbursement of Proceeds. Proceeds of Insurance policies shall be used to replace, repair or reconstruct damaged portions of the Common Area. Any proceeds remaining after defraying such costs of repairs, replacement or reconstruction of the Common Areas shall be retained by and for the benefit of the Association. This is a covenant for the benefit of any mortgagee of a Lot and may be enforced by such mortgagee.

Section 8.07 - Damage and Destruction. Immediately after the damage or destruction by fire or other casualty to all or any part of the Common Areas covered by insurance written in the name of the Association, the Board of Trustees or its duly authorized agent shall proceed with the filing and adjustment of all claims arising under such insurance and obtain reliable and detailed estimates of the cost of repair or reconstruction of the damaged or destroyed property. Repair or reconstruction, as used in this Section 8.07, means repairing

or restoring the damaged or destroyed property to substantially the same condition in which it existed prior to the fire or other casualty.

Section 8.08 - Repair, Replacement and Reconstruction. If the damage or destruction for which the insurance proceeds are paid is to be repaired, replaced or reconstructed and such proceeds are not sufficient to defray the cost thereof, the Board of Trustees shall, without the necessity of a vote of the Association's Members, levy a special assessment against all Owners in proportion to the number of Lots owned by such Owners. Additional assessments may be made in like manner at any time during or following the completion of any repair or reconstruction. If the funds available from said special assessment exceed the cost of such repair, replacement or reconstruction, such excess shall be deposited for the benefit of the Association.

Section 8.09 - Duty to Maintain Liability Insurance. The Association shall obtain and keep in full force and effect at all times, to the extent reasonably obtainable, broad form comprehensive liability insurance covering public liability for bodily injury and property damage including, but not limited to, if the Association owns or operates motor vehicles, public liability for bodily injury and property damage arising as a result of the ownership and operations of motor vehicles and director and officer insurance with policy limits and deductibles as set by the Declarant and/or the Association in its sole and absolute discretion.

Section 8.10 - General Provisions Concerning Insurance. Insurance obtained by the Association may contain such deductible provisions as good business practice may dictate. In the event that the Association sustains a loss by reason of fire or other casualty that is covered by a fire and extended coverage insurance policy, and such fire or other casualty is caused in whole or in part by the acts or omissions of the Declarant, any Member or any officer, director, agent, employee, contractor or employee of the Declarant or Member, then the Association agrees that to the extent the Association is compensated for such loss by its aforesaid insurance proceeds, the Association shall have no right of recovery against the Declarant, any Member or any officer, director, agent, employee, contractor or any employee of the Declarant or Member; and no third party shall have any such right of recovery by way of assignment, subrogation or otherwise. Insurance obtained by the Association shall, to the extent reasonably possible, and provided Declarant reimburses the Association for any additional premium payable on account thereof, name Declarant as an additional insured. Insurance policies and insurance coverage shall be reviewed at least annually by the Board of Trustees to ascertain whether coverage under the policies is sufficient in the light of the current values of the Common Area and in light of the possible or potential liabilities of the Association. Casualty, fire and extended coverage insurance may be provided under blanket policies covering the Common Area and other property of Declarant.

Section 8.11 - Other Insurance and Bonds. The Association shall obtain such other insurance as may be required by law, including worker's compensation insurance, and shall have the power to obtain such other insurance and such fidelity, indemnity or other bonds as the Association shall deem necessary or desirable.

Section 8.12 - Duty to Prepare Budgets. The Association shall prepare budgets for the Association, which budgets shall include a reserve fund for the maintenance of all Common Areas.

Section 8.13 - Duty to Levy and Collect the Maintenance Charge. The Association shall levy, collect and enforce the Maintenance Charge and other charges and assessments as elsewhere provided in this Declaration.

Section 8.14 - Duty to Prepare Annual Review. The Association shall prepare an annual, unaudited, independent review of the accounts of the Association.

Section 8.15 — Duties with Respect to Architectural Approvals. The Association shall perform functions to assist the Committee as elsewhere provided in Article IV of this Declaration.

Section 8.16 - Power to Acquire Property and Construct Improvements. The Association may acquire property or an interest in property (including leases, improvements and personal property) for the common benefit of Owners. The Association may construct improvements on the Property and may demolish existing improvements.

Section 8.17 - Power to Adopt Rules and Regulations. The Association may adopt, amend, repeal and enforce rules and regulations, fines, levies and enforcement provisions as may be deemed necessary or desirable with respect to the interpretation and implementation of this Declaration, the operation of the Association, the use and enjoyment of the Common Areas and the use of any other property within the Common Area, including Lots. Any such Rules and Regulations shall be reasonable and uniformly applied (as to all Owners, if applicable, and to Owners of similarly restricted Lots). Such Rules and Regulations shall be effective only upon adoption by resolution of the Board of Trustees. Notice of the adoption, amendment or repeal of any Rule and Regulation shall be given by posting any such Rule or Regulation for thirty (30) days after the date of adoption in the Association office, and copies of the currently effective Rules and Regulations shall be made available to each Member upon request and payment of the reasonable expense of copying the same. Each Member shall comply with such Rules and Regulations and shall see that such Member's Related Users comply with such Rules and Regulations. In the event of conflict between the Rules and Regulations and the provisions of this Declaration, the provisions of this Declaration shall prevail.

Section 8.18 - Power to Enforce Restrictions and Rules and Regulations. The Association (and any Owner with respect only to the remedies described in (ii) and (iii) below) shall have the power to enforce the provisions of this Declaration and the Rules and Regulations and shall take such action as the Board of Trustees deems necessary or desirable to cause such compliance by each Member and each Related User. Without limiting the generality of the foregoing, the Association shall have the power to enforce the provisions of this Declaration and of the Rules and Regulations of the Association by any one or more of the following means:

(i) by entry upon any property within the Subdivision after notice and hearing (unless a bona fide emergency exists in which event this right of entry may be exercised without notice (written or oral) to the Owner in such manner as to avoid any unreasonable or unnecessary interference with the lawful possession, use or enjoyment of the improvements situated thereon by the Owner or any other person), without liability by the Association to the Owner thereof, for the purpose of enforcement of this Declaration or the Rules and Regulations; (ii) by commencing and maintaining actions and suits to restrain and enjoin any breach or threatened breach of the provisions of this Declaration or the Rules and Regulations, by mandatory injunction or otherwise; (iii) by commencing and maintaining actions and suits to recover damages for breach of any of the provisions of this Declaration or the Rules and Regulations; (iv) by exclusion, after notice and hearing, of any Member or Related User from use of any recreational facilities within the Common Areas during and for up to sixty (60) days following any breach of this Declaration or such Rules and Regulations by such Member or any Related User, unless the breach is a continuing breach in which case such exclusion shall continue for so long as such breach continues; (v) by suspension, after notice and hearing, of the voting rights of a Member during and for up to sixty (60) days following any breach by such Member or a Related User of a provision of this Declaration or such Rules and Regulations, unless the breach is a continuing breach in which case such suspension shall continue for so long as such breach continues; (vi) by levying and collecting, after notice and hearing, an assessment against any Member for breach of this Declaration or such Rules and Regulations by such Member or Related User which assessment reimburses the Association for the costs incurred by the Association in connection with such breach or in connection with remedying such breach; (vii) by levying and collecting, after notice and hearing, reasonable and uniformly applied fines and penalties, established in advance in the Rules and Regulations of the Association, from any Member or Related User for breach of this Declaration or such Rules and Regulations by such Member or Related User; and (viii) by taking action itself to cure or abate such violation and to charge the expenses thereof, if any, to such violating Members, plus attorney's fees incurred by the Association with respect to exercising such remedy.

Before the Board may invoke the remedies provided above, it shall give notice by registered mail, return receipt requested, of such alleged violation to Owner, and shall afford the Owner a hearing. If, after the hearing, a violation is found to exist, the Board's right to proceed with the listed remedies shall become absolute. Each day a violation continues shall be deemed a separate violation. Failure of the Association, the Declarant, or of any Owner to take any action upon any breach or default with respect to any of the foregoing violations shall not be deemed a waiver of the right to take enforcement action thereafter or upon a subsequent breach or default.

Section 8.19 - Power to Provide Public Functions. The Association shall have the power, but not the obligation, to acquire, construct, operate, manage, maintain, repair and replace utilities, and additional public facilities, and to provide other Functions as more particularly described in this Declaration.

Section 8.20 - Power to Provide Special Services for Members. The Association shall have the power, but not the obligation, to provide special or additional services to a Member or group of Members. Any service or services to a Member or group of Members shall be provided pursuant to an agreement in writing, which shall provide for payment to the Association by such Member or group of Members of the reasonably estimated costs and expenses of the Association of providing such services, including its proportionate share of the overhead expenses of the Association and shall contain reasonable provisions assuring that the obligation to pay for such services shall be binding upon any heirs, personal representatives, successors or assigns of the Member or group of Members and that the payment for such services shall be secured by a lien on the property of the Member or group of Members as provided for in Article VI. Such additional or special services may also be deleted upon request of such Member or, if a group of Members requested such additional or special services, upon approval of such Members owning a majority of the Lots that were receiving such special or additional services.

Section 8.21 - Power to Grant Easements. In addition to any blanket easements described in this Declaration, the Association shall have the power to grant access, utility, drainage, water facility and other such easements in, on, over or under the Common Area. Additionally, the Association, from and after the Transfer Date, shall have the power to grant access, utility, drainage, water facility and other similar easements in, on, over and under Lots provided that such easements do not unreasonably interfere with the rights of the Owner of such Lots.

Section 8.22 - Power to Convey and Dedicate Property to Government Agencies. The Association shall have the power to grant, convey, dedicate or transfer any Common Areas or facilities to any public or governmental agency or authority for such purposes and subject to such terms and conditions as the Association shall deem appropriate, which power may be exercised (i) prior to the Transfer Date by the Board of Trustees and (ii) from and after the Transfer Date by the Association, with the approval of not less than two-thirds (2/3) of the Members agreeing in writing or by voting at any scheduled meeting of the Members and with the prior written approval of the Declarant. The Association may, subject to the limitations of the preceding sentence, convey property to a public or governmental agency or authority in lieu of such property being condemned by such public or governmental agency or authority.

Section 8.23 - Power to Borrow Money and Mortgage Common Area. The Association, with the prior written approval of the Declarant, shall have the power to borrow money and to encumber the Common Area as security for such borrowing, subject to the limitations provided elsewhere in this Declaration and the By-Laws with respect to required approvals and consents to such action. With respect to any deed of trust encumbering the Common Area, the lender's rights thereunder shall be limited to a right, after taking possession of such Common Area following the lender's foreclosure of the deed of trust, to charge reasonable admission and other fees as a condition to the continued enjoyment by the Members and, if necessary, until the mortgage debt is satisfied, whereupon the exclusive possession of such Common Area shall be returned to the Association.

Section 8.24 - Power to Employ Manager. The Association shall have the power to retain and pay for the services of a manager or managers to undertake the management of any of the Functions for which the Association has responsibility under this Declaration to the extent deemed advisable by the Association, and may delegate any of its duties, powers or functions to any such manager. Notwithstanding any delegation to a manager of any duties, powers or functions of the Association, the Association and its Board of Trustees shall remain ultimately responsible for the performance and exercise of such duties, powers and functions.

Section 8.25 - Power to Engage Employees Agents and Consultants. The Association shall have the power to hire and discharge employees and agents and to retain and pay for legal, accounting and other professional services as may be necessary or desirable in connection with the performance of any duties or the exercise of any powers of the Association under this Declaration.

Section 8.26 - Power to Charge Fees. The Association and its agents shall have the power to charge fees for any additional or special services the Association provides to the Members or to other individuals or entities, so long as such services are not required to be performed by the Association under these Restrictions.

Section 8.27 - General Corporate Power. The Association shall have all of the ordinary powers and rights of Texas non-profit corporation formed under the Texas Non-Profit Corporation Act, including, without limitation, entering into partnership and other agreements, subject only to such limitations upon such powers as may be set forth in this Declaration, the Articles of Incorporation, By-Laws or other dedicatory instruments. The Association shall also have the power to do any and all lawful things that may be authorized, required or permitted to be done under this Declaration, the Articles of Incorporation, By-Laws and other dedicatory instruments and to do and perform any and all acts that may be necessary or desirable for, or incidental to, the exercise of any of the express powers or rights of the Association under this Declaration, the Articles of Incorporation, By-Laws and other dedicatory instruments.

## **ARTICLE IX NATURAL GAS OR PROPANE GAS**

Section 9.01 - Non-Utilization Charge. If Declarant or Association enters into a contract with a natural gas company or a propane gas company to provide gas service to all Lots in this Section 56 ("Gas Contract"), such Gas Contract shall require minimum usage to be made of the service. Pursuant to the Gas Contract, all houses not under construction at the time the Gas Contract is entered into by the Declarant or Association shall have a minimum of gas water heating and gas central comfort heating, or pay a non-utilization fee. Therefore, the Owner of any house completed in this Section 56 (on which construction commenced following the effective date of the Gas Contract) that does not utilize both gas water heating and gas central comfort heating appliances shall pay to the natural gas company or propane gas company providing such gas service the non-utilization of gas facilities charge set out in the Gas Contract. This non-utilization charge shall be due thirty (30) days from completion of the non-utilizing house. In the event this non-utilization charge is not paid timely by the Owner of the non-utilizing house, after demand is made for such payment, the Declarant or Association may, at its option, pay such charge and the payment so made, if any, shall be secured by the lien securing the payment of the Maintenance Charge described in Article VI of this Declaration, which lien shall only be extinguished by payment of such charge, plus attorneys' fees, costs and interest on the amount paid by the Declarant or the Association until Declarant or the Association is reimbursed therefore at the lesser of: (i) eighteen percent (18%) per annum or (ii) the maximum rate permitted by applicable law.

Section 9.02 - Underground Natural Gas or Propane Gas Service Connection and Meter Location. If the Declarant or Association enters into a Gas Contract with a natural gas company or a propane gas company to provide gas service to all Lots in this Section 56, the following restrictions and conditions shall apply with respect to all Owners who have not commenced construction of their respective residences and to any Owners who have commenced construction of their respective residences but who elect to receive service under the Gas Contract:



(a) The residential gas meter, unless otherwise approved by the Committee, shall be located along the side of the house and within ten (10) feet from the front corner of the house. In the event the gas meter shall be located behind a fence, the Owner or Builder shall provide a gate near the meter location as access for the gas company to read the meter.

(b) The requirements with respect to construction, costs of construction and future maintenance of the gas service line from the gas main to the gas meter location, which are binding on the Owners, shall be determined in accordance with the Gas Contract with the Declarant or Association.

(c) In the event the Gas Contract provides for the gas company to construct the gas service line from the gas main to the gas meter: (i) the Owner or Builder shall pay to the gas company a fee to be determined by the gas company for such construction, and (ii) there is hereby dedicated a five (5) foot wide gas service utility easement, extending from the surface of the ground downward, said easement being two and one-half (2 ½) feet on each side of the gas service line as now, or hereafter constructed, and will extend along the route selected by the gas company for its gas main to the gas meter when and as located upon Lots and Reserves in the Subdivision. The gas company shall have the right to excavate said easement strip and to remove objects, structures, growths or protrusions thereon. The Owner's use of this utility easement is subject to the provisions in Section 2.04.

Section 9.03 - Individual Propane Tanks. If the Declarant or Association enters into the Gas Contract with a natural gas company or propane gas company to provide gas service to all Lots in this Section 56, individual propane tanks may not be installed to service a residence. However, if no Gas Contract is entered into prior to an Owner's commencement of construction of a residence, then such Owner may have the option of supplying propane gas service to his or her residence with installation of an individual propane tank subject to the following restrictions:

(a) Gas piping within and outside of the residence must be installed in accordance with the rules and regulations as established or may be established by the Texas Railroad Commission (and any other applicable governmental agency). The plumber installing such gas piping must be licensed by the Texas Railroad Commission (and any other applicable governmental agency).

(b) The propane tank must be buried with a minimum of two (2) feet of cover complete with appropriate venting and with cathodic protection. The buried tank must be located a minimum of ten (10) feet from any building and ten (10) feet from any property line. The propane tank must be constructed of materials and designed for a minimum twenty (20) year usable life. Installation requirements and location must meet the minimum specifications as established or will be established by the Texas Railroad Commission and any other applicable governmental agency.

## **ARTICLE X ELECTRICAL SERVICE**

Section 10.01 - Underground Residence Electrical Service Connection. Entergy/Gulf States Utilities Co. shall, in accordance with policies established by Entergy/Gulf States Utilities Co. from time to time, construct the underground service cable and appurtenances from the point of the electric company's metering at the residence to the point of attachment at such company's transformers or energized secondary junction boxes under and across an easement provided for such construction. The Owner of each Lot shall pay to Entergy/Gulf States Utilities Co. the cost of constructing such underground service cable and appurtenance in an amount to be determined by Entergy/Gulf States Utilities Co.

## **ARTICLE XI GENERAL PROVISIONS**

Section 11.01 - Term. The provisions hereof shall run with all property in the Subdivision and shall be binding upon all Owners and all persons claiming under them for a period of forty (40) years from the date this Declaration is recorded, after which time said Declaration shall be automatically extended for successive periods of ten (10) years each,

unless an instrument, signed by Owners (including the Declarant) owning not less than two-thirds (2/3) of the Lots has been recorded agreeing to amend or change, in whole or in part, this Declaration.

Section 11.02 - Amendments. This Declaration may be amended or changed, in whole or in part, at any time by the written agreement or signed ballot of Owners (including the Declarant) entitled to cast not less than two-thirds (2/3) of the votes of all of the Owners. If the Declaration is amended by a written instrument signed by those Owners entitled to cast not less than two-thirds (2/3) of all of the votes of the Owners of the Association, such amendment must be approved by said Owners within three hundred sixty-five (365) days of the date the first Owner executes such amendment. The date an Owner's signature is acknowledged shall constitute prima facie evidence of the date of execution of said amendment by such Owner.

Those Owners are entitled to cast not less than two-thirds (2/3) of all of the votes of the Members of Association may also vote to amend this Declaration, in person or by proxy, at a meeting of the Owners duly called for such purpose, written notice of which shall be given to all Owners at least ten (10) days and not more than sixty (60) days in advance and shall set forth the purpose of such meeting. Notwithstanding any provision contained in the By-Laws to the contrary, a quorum, for purposes of such meeting, shall consist of not less than seventy percent (70%) of all of the Owners (in person or by proxy) entitled to vote. Any such amendment shall become effective when an instrument is filed for record in the Real Property Records of Montgomery County, Texas, accompanied by a certificate, signed by a majority of the Board of Trustees, stating that the required number of Owners executed the instrument amending this Declaration or cast a written vote, in person or by proxy, in favor of said amendment at the meeting called for such purpose. Copies of the written ballots pertaining to such amendment shall be retained by the Association for a period of not less than three (3) years after the date of filing of the amendment or termination.

Section 11.03 - Amendments by the Declarant. In addition to any other right given hereunder pertaining to amendments, the Declarant shall have and reserves the right at any time and from time to time prior to the Transfer Date, without the joinder or consent of any Owner or other party, to amend this Declaration by an instrument in writing duly signed, acknowledged, and filed for record for the purpose of correcting any typographical or grammatical error, oversight, ambiguity or inconsistency appearing herein, provided that any such amendment shall be consistent with and in furtherance of the general plan and scheme of development as evidenced by this Declaration and shall not impair or adversely affect the vested priority or other rights of any Owner or his or her mortgagee. Additionally, Declarant shall have and reserves the right at any time and from time to time prior to the Transfer Date, without the joinder or consent of any Owner or other party, to amend this Declaration by an instrument in writing duly signed, acknowledged and filed for record for the purpose of permitting the Owners to enjoy the benefits from technological advances, such as personal or home protection, alarm, communications (including television) or energy-related devices or equipment that did not exist or were not in common use in residential subdivisions at the time this Declaration was adopted. Likewise, the Declarant shall have and reserves the right at any time and from time to time prior to the Transfer Date, without the joinder or consent of any Owner or other party, to amend this Declaration by an instrument in writing duly signed, acknowledged and filed for record for the purpose of prohibiting the use of any device or apparatus developed and/or available for residential use following the date of this Declaration if the use of such device or apparatus will adversely affect the Association or will adversely affect the property values within the Subdivision. The Declarant shall have and reserves the right to transfer to the Association at any time any right held and/or reserved to the Declarant under this Section, which transfer shall be evidenced by an instrument executed by the Declarant and filed for record in the real property records of Montgomery County, Texas.

Section 11.04 - Severability. Each of the provisions of this Declaration shall be deemed independent and severable and the invalidity of unenforceability or partial invalidity or partial unenforceability of any provision or portion hereof shall not affect the validity or enforceability of any other provision.



Section 11.05 - Mergers and Consolidations. The Association may participate in mergers and consolidations with other non-profit corporations organized for the same or similar purposes, provided that (i) prior to the Transfer Date any such merger or consolidation shall be approved (in writing or at a meeting duly called for such purpose) by two-thirds (2/3) of the Trustees and (ii) from and after the Transfer Date any such merger or consolidation shall have the consent (in writing or at a meeting duly called for such purpose) of those Members entitled to cast not less than two-thirds (2/3) of the votes of all of the Members of the Association and the Declarant.

Upon a merger or consolidation of the Association with another association as provided in its Articles of Incorporation, the properties, rights and obligations may, by operation of law, be transferred to another surviving or consolidated association, or alternatively, the properties, rights and obligations of the other association may, by operation of law, be added to the properties, rights and obligations of the Association as a surviving corporation pursuant to the merger. The surviving or consolidated association will be subject to the covenants and restrictions established by this Declaration within the Subdivision, together with the covenants and restrictions established upon any other properties as one scheme. No such merger or consolidation, however, shall effect any revocation, change or addition to the covenants and restrictions established by this Declaration, except as changed by amendment of this Declaration or by the plan of merger or consolidation. In the event of any inconsistency between the terms and provisions of this Declaration and the terms and provisions of any of the merger or consolidation documents, the terms and provisions of the merger or consolidation documents shall control.

Section 11.06 - Liberal Interpretation. The provisions of this Declaration shall be liberally construed as a whole to effectuate the purpose of this Declaration.

Section 11.07 - Successors and Assigns. The provisions hereof shall be binding upon and inure to the benefit of the Owners, the Declarant and the Association, and their respective heirs, legal representatives, executors, administrators, successors and assigns.

Section 11.08 - Effect of Violations on Mortgagees. No violation of the provisions herein contained, or any portion thereof, shall affect the lien of any mortgage or deed of trust presently or hereafter placed of record or otherwise affect the rights of the mortgagee under any such mortgage, the holder of any such lien or beneficiary of any such deed of trust; and any such mortgage, lien, or deed of trust may, nevertheless, be enforced in accordance with its terms, subject, nevertheless, to the provisions herein contained.

Section 11.09 - Terminology. All personal pronouns used in this Declaration and all exhibits attached hereto, whether used in the masculine, feminine or neuter gender, shall include all other genders; the singular shall include the plural and vice versa. Title of Articles and Sections are for convenience only and neither limit nor amplify the provisions of this Declaration itself. All references in this Declaration to Exhibits shall refer to the Exhibits attached hereto.

Section 11.10 - Effect on Annexable Area. The provisions of this Declaration do not impose any restrictions whatsoever or otherwise encumber the Annexable Area, unless and until portions of the Annexable Area are made subject to the jurisdiction of the Association by a separate instrument executed solely by Declarant or its successors and assigns and any lienholders, which instrument is recorded in the Real Property Records of Montgomery County, Texas.

Section 11.11 - Declarant's Rights and Prerogatives. Prior to the Transfer Date, the Declarant may file a statement in the Real Property Records of Montgomery County, Texas, that expressly provides for the Declarant's (i) discontinuance of the exercise of any right or prerogative provided for in this Declaration to be exercised by the Declarant or (ii) assignment to any third party owning property in the Subdivision, Annexable Area or to the entities owning the Bentwater Yacht & Country Club, of one or more of Declarant's specific rights and prerogatives provided in this Declaration to be exercised by Declarant.

The assignee designated by Declarant to exercise one or more of Declarant's rights or prerogatives hereunder shall be entitled to exercise such right or prerogative until the earlier to occur of the (i) Transfer Date or (ii) date that said assignee files a statement in the Real Property Records of Montgomery County, Texas, that expressly provides for said assignee's discontinuance of the exercise of said right or prerogative. From and after the date that the Declarant discontinues its exercise of any right or prerogative hereunder and/or assigns its right to exercise one or more of its rights or prerogatives to an assignee, the Declarant shall not incur any liability to any Owner, the Association or any other party by reason of the Declarant's discontinuance or assignment of the exercise of said right(s) or prerogative(s).

Section 11.12 - Accommodation. Reasonable accommodations under these Restrictions shall be made in order to comply with any special needs of the Owners as required by local, state and federal laws.

IN WITNESS WHEREOF, the undersigned, being the Declarant herein, Bentwater on the North Shore, Ltd., a Texas Limited Partnership, has caused these presents to be signed by J.B. Belin, Jr., as manager of J.B. - G.P., L.L.C. as sole General Partner of J.B. Land Co., Ltd., as sole General Partner of Bentwater on the North Shore, Ltd., hereunto set its hand as of May 2nd, 2000.

Bentwater on the North Shore, Ltd.,  
A Texas Limited Partnership

By: J.B. Land Co., Ltd., General Partner

By: J.B. - G.P., L.L.C., General Partner

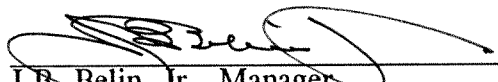
By:   
J.B. Belin, Jr., Manager

STATE OF TEXAS

COUNTY OF Harris

BEFORE ME, the undersigned authority, on this the 2 day of May, 2000, personally appeared J.B. Belin, Jr., as Manager of J.B. - G.P., L.L.C., as sole General Partner of J.B. Land Co., Ltd., a Texas Limited Partnership, as sole General Partner of Bentwater on the North Shore, Ltd., on behalf of said limited partnership, known to me to be the person whose name is subscribed to the foregoing instrument and acknowledged to me that he executed the same for the purposes of consideration therein expressed and in the capacity therein and herein set out, and as the act and deed of said Limited Partnership.

(SEAL)

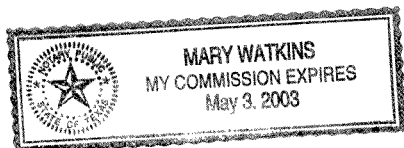

  
NOTARY PUBLIC, STATE OF TEXAS

JOINDER OF LIENHOLDER

Omega Financial Services, Ltd., a Texas Limited Partnership, owner and holder of a mortgage lien and/or other liens, assignments and security interests encumbering all or a portion of the Property hereby consents to the terms and provisions of this Declaration of Covenants, Conditions and Restrictions for Bentwater Section 56 to which this Joinder is attached and acknowledges that the execution thereof does not constitute a default under the lien document or other document executed in connection with or as security for the indebtedness above described and subordinates the liens of the lien document and any other liens and/or security instruments securing said indebtedness to the rights and interests created under said Declaration, and acknowledges and agrees that a foreclosure of said liens and/or security interests shall not extinguish the rights, obligations and interests created under this Declaration. No warranties of title are hereby made by lienholder, lienholder's joinder hereunder being solely limited to such consent and subordination.

OMEGA FINANCIAL SERVICES, LTD.,  
a Texas limited partnership,  
by its sole General Partner

By: Alpha Advisory Group, Inc.,  
a Texas corporation

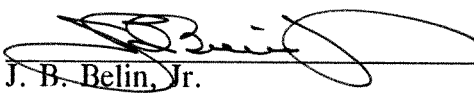
By:   
J. B. Belin, Jr.  
President and Secretary

STATE OF TEXAS :

COUNTY OF Harris :

This instrument was acknowledged before me on May 2, <sup>2000</sup>~~199~~,  
by J. B. Belin, Jr. of Omega Financial Services, Ltd., a Texas Limited Partnership, on behalf  
of such entity and in the capacity therein stated.

  
Notary Public, State of Texas

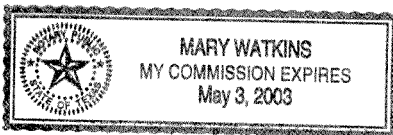

**EXHIBIT "A"**  
**BENTWATER**

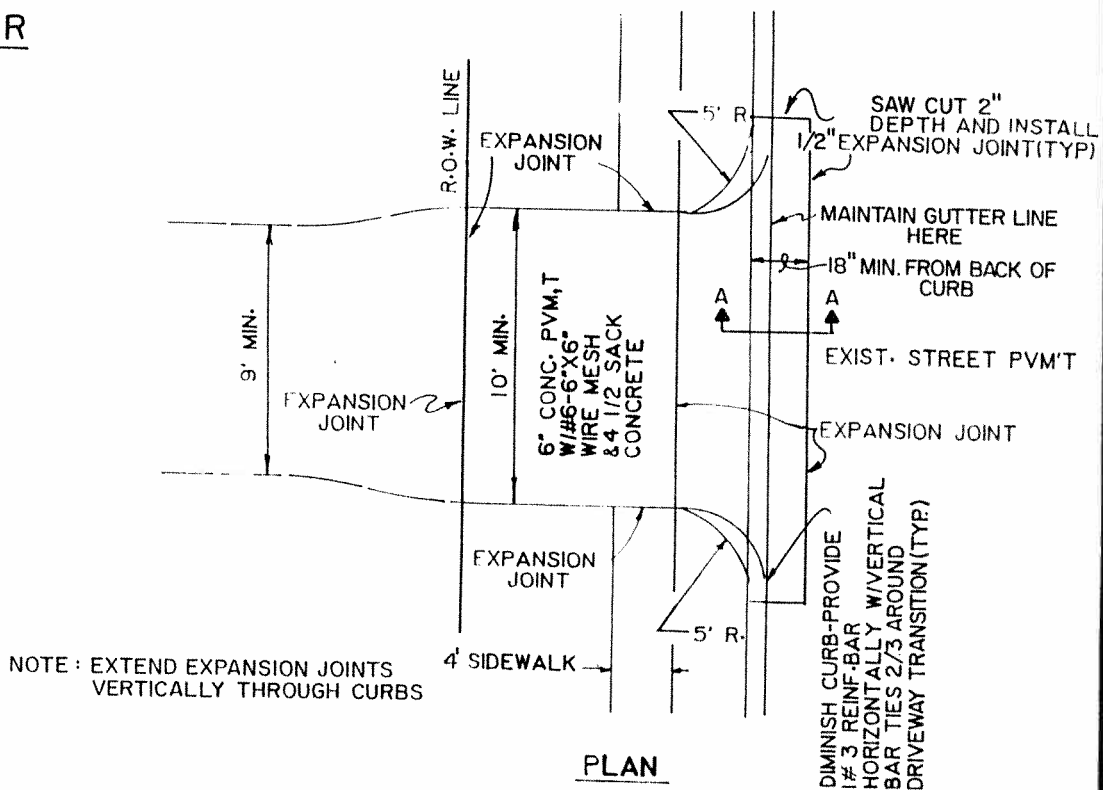

**CONCRETE DRIVEWAY DETAIL**

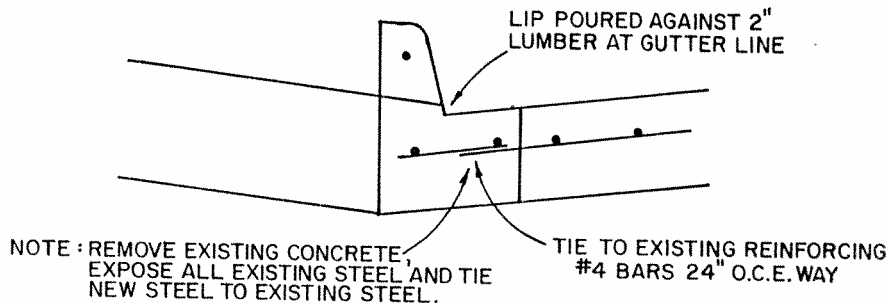

6" DRIVEWAY WITH  
No. 6-6"X6" WIRE MESH  
& 4 1/2 SACK CONCRETE

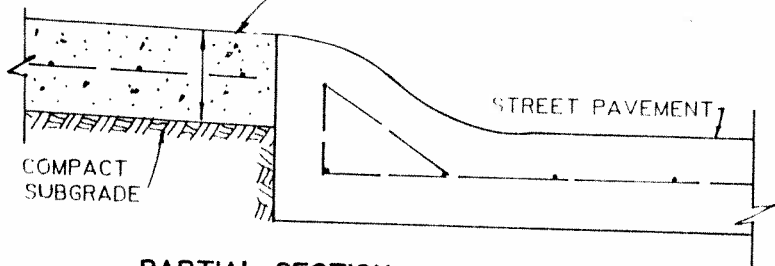

**ROLL-UP CURB CONCRETE DRIVEWAY DETAIL**

**CONCRETE CURB REPAIR REQUIREMENTS**

CONCRETE CURBS THAT ARE CHIPPED, CRACKED AND/OR BROKEN ON THE STREET FRONT OR STREET SIDE OF ALL LOTS ARE TO BE REPAIRED OR REPLACED BY THE BUILDER OR OWNER OF THE RESIDENCE ON EACH LOT PRIOR TO THE OCCUPANCY OF THE RESIDENCE ON SAID LOT. CHIPPED CURBS MAY HAVE PATCHED REPAIRS USING AN "EPOXY GROUT" MIXTURE. CRACKED OR BROKEN STANDARD CURBS ("STANDUP CURBS") SHALL BE SAW CUT ON BOTH SIDES OF THE CRACK OR BREAK, THE CRACKED OR BROKEN AREA REMOVED, REFORMED AND Poured USING FIVE (5) SACK CONCRETE MIX AND REINFORCING STEEL REBARS AND PLACING AN EXPANSION JOINT ON EACH SIDE OF CURB CUT.

EXHIBIT "B"  
BENT WATER

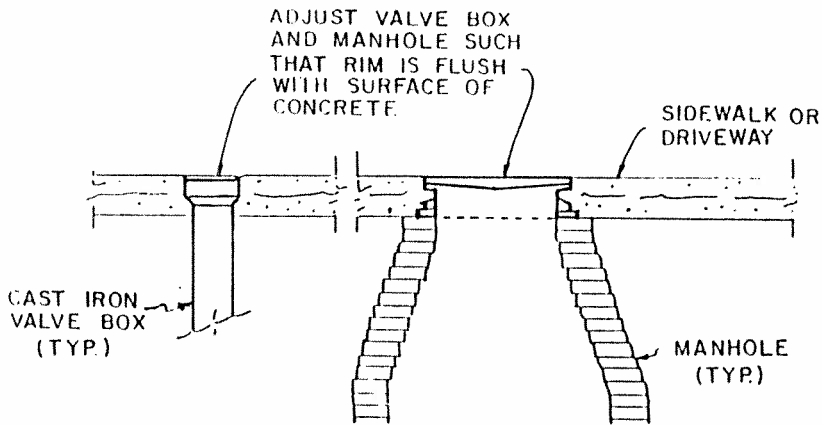
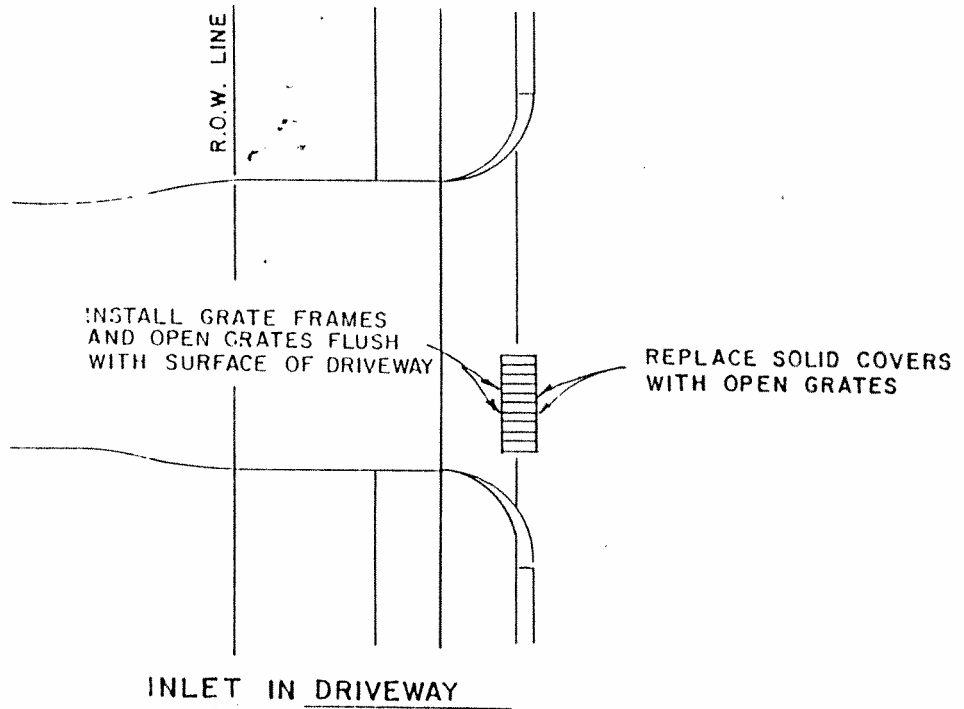

WATER VALVE BOX AND  
MANHOLE IN SIDEWALK OR DRIVEWAY

STATE OF TEXAS  
COUNTY OF MONTGOMERY  
I hereby certify that this instrument was filed in  
File Number Sequence on the date and at the time  
stamped herein by me and was duly RECORDED in  
the official Public Records of Real Property of  
Montgomery County, Texas.

MAY - 5 2000



*Mark Turnbull*  
COUNTY CLERK  
MONTGOMERY COUNTY, TEXAS

FILED FOR RECORD  
00 MAY - 5 AM 10:19  
MARK TURNBULL, CO. CLERK  
MONTGOMERY COUNTY, TEXAS  
*A* DEPUTY

CERTIFIED COPY CERTIFICATE  
STATE OF TEXAS  
COUNTY OF MONTGOMERY  
A true and correct copy, I hereby certify as the same  
appears under BOOK 237598 of the Real Property  
records in the County Clerk's Office in Montgomery  
County, Texas.



MARK TURNBULL  
COUNTY CLERK  
COUNTY OF MONTGOMERY

By: *Brenda Randall* Deputy

SECOND AMENDMENT TO CLARIFY THE DECLARATIONS OF COVENANTS, CONDITIONS AND RESTRICTIONS FOR BENTWATER

STATE OF TEXAS §  
COUNTY OF MONTGOMERY §

WHEREAS, Bentwater on the North Shore, Ltd., ("Declarant"), a Texas Limited Partnership, executed certain Declarations of Covenants, Conditions and Restrictions Bentwater (hereinafter referred to collectively as the "Declarations") for multiple sections more particularly described on the attached Exhibit "A", all of which were filed for record in the Official Public Records of Real Property of Montgomery County, Texas; and

WHEREAS, pursuant to the terms of the Declarations, the Declarant reserved the unilateral right to amend the Declarations for the purpose of correcting any typographical or grammatical error, oversight, ambiguity, or inconsistency appearing therein; and

WHEREAS, there is a potential ambiguity, regarding the obligation that each Owner of a Lot maintain a Social Membership, as same is defined in the Declarations, for each Lot; and

WHEREAS, the Declarations intend for each Lot Owner to have a Social Membership, and the Declarant seeks to make a minor clarification to prevent future misinterpretation ;and

WHEREAS, reference is hereby made to the Declarations for all purposes, and any and all capitalized terms used herein shall have the meanings set forth in the Declarations, unless otherwise specified in this Second Amendment to Clarify the Declarations of Covenants, Conditions and Restrictions For Bentwater (the "Second Amendment to Clarify").

NOW THEREFORE, in consideration of these premises, the Declarant hereby amends the Declarations as follows:

The following amendment is hereby incorporated as the Final Article to the Declarations as if the same had been made a part thereof as originally recorded:

Final Article "Additional Provision" shall be inserted as follows:

Social Membership. Notwithstanding anything contained in the Declarations to the contrary, a Social Membership, as previously defined, shall be required to be maintained on each and every Lot, and the Owner of multiple Lots shall be obligated to maintain a Social Membership on each and every Lot owned.

By way of illustration and not limitation:

- (1) If an Owner of two or more adjacent Lots consolidates those adjacent Lots (pursuant to the Lot Consolidation procedure established by the Association), with the prior approval of the Bentwater Property Owners Association, Inc. and the Bentwater Architectural Control Committee, to create one building site, such consolidated building site shall be obligated to maintain one single Social Membership. If the consolidation of the adjacent Lots is terminated, each and

every Lot that made up the consolidated building site shall once again become obligated to maintain one Social Membership per Lot.

- (2) If an Owner owns two or more Lots, whether adjacent or not, that have not been consolidated into one building site, that Owner must maintain a Social Membership on each and every Lot owned.

If any provision of this Second Amendment to Clarify is found to be in conflict with the Declarations, as amended, this Second Amendment to Clarify shall control.

The Declarations, as hereby amended, are in all respects ratified and confirmed and shall remain in full force and effect.

SIGNED this the 31st day of August, 2005.

DECLARANT:

BENTWATER ON THE NORTH SHORE, LTD., A  
Texas limited partnership

By: J.B. Land Co., Ltd., General Partner  
By: J.B.-G.P., L.L.C., General Partner

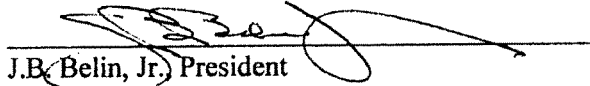
  
J.B. Belin, Jr., President

STATE OF TEXAS       §  
                                  §  
COUNTY OF HARRIS   §

BEFORE ME, the undersigned authority, on this day personally appeared J.B. Belin, Jr., the President of J.B.-G.P., L.L.C., General Partner of BENTWATER ON THE NORTH SHORE, LTD., A Texas limited partnership known to me to be the person whose name is subscribed to the foregoing instrument, and acknowledged to me that he executed the same for the purpose and consideration therein expressed, in the capacity therein stated and as the act and deed of said corporation.

SIGNED this the 31st day of August, 2005.

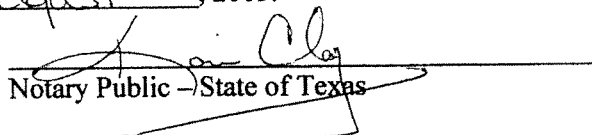
  
Notary Public - State of Texas

After Recording Return To:

Please return to:  
Bentwater O.T.N.S., Ltd.  
17210 West FM 1097  
Montgomery, Texas 77356

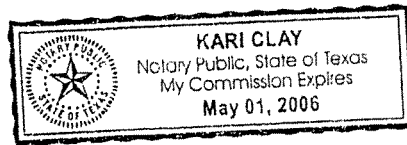

## EXHIBIT "A"

SECTION	DATE RECORDED	CLERK'S FILE #	DOCUMENT
1	05/29/87	8722563	Declaration of Covenants, Conditions & Restrictions Bentwater Section 1
1	03/10/88	8811534	First Amendment to the Declaration of Covenants, Conditions & Restrictions Bentwater Section 1
1	11/16/00	2000-97722	Amendment to Clarify the Declarations of Covenants, Conditions and Restrictions for Bentwater
2	07/12/88	8834614	Declaration of Covenants, Conditions & Restrictions Bentwater Section 2
2	11/16/00	2000-97722	Amendment to Clarify the Declarations of Covenants, Conditions and Restrictions for Bentwater
3	05/29/87	8722564	Declaration of Covenants, Conditions & Restrictions Bentwater Section 3
3	11/16/00	2000-97723	Amendment to Clarify the Declarations of Covenants, Conditions and Restrictions for Bentwater
4	08/27/87	8738871	Declaration of Covenants, Conditions & Restrictions Bentwater Section 4
4	11/16/00	2000-97722	Amendment to Clarify the Declarations of Covenants, Conditions and Restrictions for Bentwater
5	05/29/87	8722562	Declaration of Covenants, Conditions & Restrictions Bentwater Section 5
5	11/16/00	2000-97723	Amendment to Clarify the Declarations of Covenants, Conditions and Restrictions for Bentwater
6	05/10/88	8822514	Declaration of Covenants, Conditions & Restrictions Bentwater Section 6
6	05/23/88	8824802	First Amendment to the Declaration of Covenants, Conditions & Restrictions Bentwater Section 6
6	11/16/00	2000-97722	Amendment to Clarify the Declarations of Covenants, Conditions and Restrictions for Bentwater
7	06/26/89	8926721	Declaration of Covenants, Conditions & Restrictions Bentwater Section 7



7	11/16/00	2000-97722	Amendment to Clarify the Declarations of Covenants, Conditions and Restrictions for Bentwater
8	03/31/89	8912912	Declaration of Covenants, Conditions & Restrictions Bentwater Section 8
8	11/16/00	2000-97723	Amendment to Clarify the Declarations of Covenants, Conditions and Restrictions for Bentwater
9	07/12/88	8834615	Declaration of Covenants, Conditions & Restrictions Bentwater Section 9
9	11/16/00	2000-97723	Amendment to Clarify the Declarations of Covenants, Conditions and Restrictions for Bentwater
10	03/31/89	8912913	Declaration of Covenants, Conditions & Restrictions Bentwater Section 10
10	11/16/00	2000-97723	Amendment to Clarify the Declarations of Covenants, Conditions and Restrictions for Bentwater
11	03/31/89	8912915	Declaration of Covenants, Conditions & Restrictions Bentwater Section 11
11	11/16/00	2000-97723	Amendment to Clarify the Declarations of Covenants, Conditions and Restrictions for Bentwater
12	06/08/89	8924315	Declaration of Covenants, Conditions & Restrictions Bentwater Section 12
12	11/16/00	2000-97722	Amendment to Clarify the Declarations of Covenants, Conditions and Restrictions for Bentwater
14	03/31/89	8912914	Declaration of Covenants, Conditions & Restrictions Bentwater Section 14
14	11/16/00	2000-97723	Amendment to Clarify the Declarations of Covenants, Conditions and Restrictions for Bentwater
15	12/13/90	9052693	Declaration of Covenants, Conditions & Restrictions Bentwater Section 15
15	11/16/00	2000-97722	Amendment to Clarify the Declarations of Covenants, Conditions and Restrictions for Bentwater
16	10/21/94	9459171	Declaration of Covenants, Conditions & Restrictions Bentwater Section 16

EXHIBIT "A"

16	11/16/00	2000-97722	Amendment to Clarify the Declarations of Covenants, Conditions and Restrictions for Bentwater
17	06/08/89	8924314	Declaration of Covenants, Conditions & Restrictions Bentwater Section 17
17	11/16/00	2000-97722	Amendment to Clarify the Declarations of Covenants, Conditions and Restrictions for Bentwater
18	04/10/90	9014194	Declaration of Covenants, Conditions & Restrictions Bentwater Section 18
18	11/16/00	2000-97722	Amendment to Clarify the Declarations of Covenants, Conditions and Restrictions for Bentwater
19	04/10/90	9014195	Declaration of Covenants, Conditions & Restrictions Bentwater Section 19
19	11/16/00	2000-97722	Amendment to Clarify the Declarations of Covenants, Conditions and Restrictions for Bentwater
20	07/26/90	9030659	Declaration of Covenants, Conditions & Restrictions Bentwater Section 20
20	11/16/00	2000-97723	Amendment to Clarify the Declarations of Covenants, Conditions and Restrictions for Bentwater
21	06/21/90	9025193	Declaration of Covenants, Conditions & Restrictions Bentwater Section 21
21	11/16/00	2000-97722	Amendment to Clarify the Declarations of Covenants, Conditions and Restrictions for Bentwater
22	04/10/90	9014196	Declaration of Covenants, Conditions & Restrictions Bentwater Section 22
22	11/16/00	2000-97723	Amendment to Clarify the Declarations of Covenants, Conditions and Restrictions for Bentwater
23	09/12/90	9039161	Declaration of Covenants, Conditions & Restrictions Bentwater Section 23
23	11/16/00	2000-97723	Amendment to Clarify the Declarations of Covenants, Conditions and Restrictions for Bentwater
24	08/15/90	9034285	Declaration of Covenants, Conditions & Restrictions Bentwater Section 24

EXHIBIT "A"

24	11/16/00	2000-97722	Amendment to Clarify the Declarations of Covenants, Conditions and Restrictions for Bentwater
25	04/22/91	9116594	Declaration of Covenants, Conditions & Restrictions Bentwater Section 25
25	07/11/91	9130301	First Amendment to the Declaration of Covenants, Conditions & Restrictions Bentwater Section 25
25	11/16/00	2000-97723	Amendment to Clarify the Declarations of Covenants, Conditions and Restrictions for Bentwater
26	05/06/91	9119214	Declaration of Covenants, Conditions & Restrictions Bentwater Section 26
26	11/16/00	2000-97722	Amendment to Clarify the Declarations of Covenants, Conditions and Restrictions for Bentwater
27	08/13/91	9133384	Declaration of Covenants, Conditions & Restrictions Bentwater Section 27
27	08/13/91	9136221	First Amended to the Declaration of Covenants, Conditions & Restrictions Bentwater Section 27
27	11/16/00	2000-97723	Amendment to Clarify the Declarations of Covenants, Conditions and Restrictions for Bentwater
28	02/22/95	9509527	Declaration of Covenants, Conditions & Restrictions Bentwater Section 28
28	11/16/00	2000-97723	Amendment to Clarify the Declarations of Covenants, Conditions and Restrictions for Bentwater
29	03/07/91	9109356	Declaration of Covenants, Conditions & Restrictions Bentwater Section 29
29	11/16/00	2000-97722	Amendment to Clarify the Declarations of Covenants, Conditions and Restrictions for Bentwater
30A	05/29/92	9226016	Declaration of Covenants, Conditions & Restrictions Bentwater Section 30
30A	11/16/00	2000-97722	Amendment to Clarify the Declarations of Covenants, Conditions and Restrictions for Bentwater
31	04/06/93	9316558	Declaration of Covenants, Conditions & Restrictions Bentwater Section 31

EXHIBIT "A"

31	11/16/00	2000-97722	Amendment to Clarify the Declarations of Covenants, Conditions and Restrictions for Bentwater
32	05/29/92	9226017	Declaration of Covenants, Conditions & Restrictions Bentwater Section 32
32	11/16/00	2000-97722	Amendment to Clarify the Declarations of Covenants, Conditions and Restrictions for Bentwater
33	05/29/92	9226015	Declaration of Covenants, Conditions & Restrictions Bentwater Section 33
33	11/16/00	2000-97722	Amendment to Clarify the Declarations of Covenants, Conditions and Restrictions for Bentwater
34	10/12/95	9557197	Declaration of Covenants, Conditions & Restrictions Bentwater Section 34
34	11/16/00	2000-97723	Amendment to Clarify the Declarations of Covenants, Conditions and Restrictions for Bentwater
35	04/06/93	9316559	Declaration of Covenants, Conditions & Restrictions Bentwater Section 35
35	11/16/00	2000-97723	Amendment to Clarify the Declarations of Covenants, Conditions and Restrictions for Bentwater
36	02/22/95	9509526	Declaration of Covenants, Conditions & Restrictions Bentwater Section 36
36	11/16/00	2000-97723	Amendment to Clarify the Declarations of Covenants, Conditions and Restrictions for Bentwater
37	01/22/93	9303553	Declaration of Covenants, Conditions & Restrictions Bentwater Section 37
37	02/09/93	9306774	First Amendment to the Declaration of Covenants, Conditions & Restrictions Bentwater Section 37
37	11/16/00	2000-97722	Amendment to Clarify the Declarations of Covenants, Conditions and Restrictions for Bentwater
38	04/06/93	9316557	Declaration of Covenants, Conditions & Restrictions Bentwater Section 38
38	05/21/93	9325726	First Amendment to the Declaration of Covenants, Conditions & Restrictions Bentwater Section 38

EXHIBIT "A"

38	11/16/00	2000-97722	Amendment to Clarify the Declarations of Covenants, Conditions and Restrictions for Bentwater
39	04/15/94	9420835	Declaration of Covenants, Conditions & Restrictions Bentwater Section 39
39	08/10/94	9445218	First Amendment to the Declaration of Covenants, Conditions & Restrictions Bentwater Section 39
39	11/16/00	2000-97722	Amendment to Clarify the Declarations of Covenants, Conditions and Restrictions for Bentwater
40	04/01/05	2005-032927	Declaration of Covenants, Conditions & Restrictions Bentwater Section 40
41	03/14/97	9714658	Declaration of Covenants, Conditions & Restrictions Bentwater Section 41
41	11/16/00	2000-97723	Amendment to Clarify the Declarations of Covenants, Conditions and Restrictions for Bentwater
42	05/11/95	9525316	Declaration of Covenants, Conditions & Restrictions Bentwater Section 42
42	11/16/00	2000-97722	Amendment to Clarify the Declarations of Covenants, Conditions and Restrictions for Bentwater
43	05/07/04	2004-049024	Declaration of Covenants, Conditions & Restrictions Bentwater Section 43
44	07/14/94	9431718	Declaration of Covenants, Conditions & Restrictions Bentwater Section 44
44	07/14/94	9439187	First Amended Declaration of Covenants, Conditions & Restrictions Bentwater Section 44
44	11/16/00	2000-97722	Amendment to Clarify the Declarations of Covenants, Conditions and Restrictions for Bentwater
45	11/07/97	9772303	Declaration of Covenants, Conditions & Restrictions Bentwater Section 45
45	11/16/00	2000-97723	Amendment to Clarify the Declarations of Covenants, Conditions and Restrictions for Bentwater
46	04/24/98	9828859	Declaration of Covenants, Conditions & Restrictions Bentwater Section 46

EXHIBIT "A"

46	11/16/00	2000-97722	Amendment to Clarify the Declarations of Covenants, Conditions and Restrictions for Bentwater
47	04/01/05	2005-032926	Declaration of Covenants, Conditions & Restrictions Bentwater Section 47
48	03/06/03	2003-025471	Declaration of Covenants, Conditions & Restrictions Bentwater Section 48
49	03/06/03	2003-025470	Declaration of Covenants, Conditions & Restrictions Bentwater Section 49
50	05/24/96	9631194	Declaration of Covenants, Conditions & Restrictions Bentwater Section 50
51	02/09/99	99009806	Declaration of Covenants, Conditions & Restrictions Bentwater Section 51
51	11/16/00	2000-97722	Amendment to Clarify the Declarations of Covenants, Conditions and Restrictions for Bentwater
54	03/14/97	9714657	Declaration of Covenants, Conditions & Restrictions Bentwater Section 54
54	11/16/00	2000-97722	Amendment to Clarify the Declarations of Covenants, Conditions and Restrictions for Bentwater
55	11/06/98	9888673	Declaration of Covenants, Conditions & Restrictions Bentwater Section 55
55	11/16/00	2000-97723	Amendment to Clarify the Declarations of Covenants, Conditions and Restrictions for Bentwater
56	05/05/00	2000-037298	Declaration of Covenants, Conditions & Restrictions Bentwater Section 56
56	11/16/00	2000-97722	Amendment to Clarify the Declarations of Covenants, Conditions and Restrictions for Bentwater
57	04/22/96	9623788	Declaration of Covenants, Conditions & Restrictions Bentwater Section 57
57	11/16/00	2000-97722	Amendment to Clarify the Declarations of Covenants, Conditions and Restrictions for Bentwater
58	04/22/96	9623787	Declaration of Covenants, Conditions & Restrictions Bentwater Section 58

EXHIBIT "A"

58	11/16/00	2000-97722	Amendment to Clarify the Declarations of Covenants, Conditions and Restrictions for Bentwater
59	04/22/96	9623789	Declaration of Covenants, Conditions & Restrictions Bentwater Section 59
59	11/16/00	2000-97723	Amendment to Clarify the Declarations of Covenants, Conditions and Restrictions for Bentwater
60	10/12/00	2000-087459	Declaration of Covenants, Conditions & Restrictions Bentwater Section 60
63	06/04/97	9733180	Declaration of Covenants, Conditions & Restrictions Bentwater Section 63
63	11/16/00	2000-97722	Amendment to Clarify the Declarations of Covenants, Conditions and Restrictions for Bentwater
64	06/04/97	9733181	Declaration of Covenants, Conditions & Restrictions Bentwater Section 64
64	12/06/99	99100717	First Amendment of Declaration of Covenants, Conditions & Restrictions Bentwater Section 64
64	11/16/00	2000-097723	Amendment to Clarify the Declaration of Covenants, Conditions & Restrictions Bentwater Section 64
64	11/16/00	0097723	Amendment to Clarify the Declarations of Covenants, Conditions and Restrictions for Bentwater
65	02/26/98	9812705	Declaration of Covenants, Conditions & Restrictions Bentwater Section 65
65	11/16/00	2000-97723	Amendment to Clarify the Declarations of Covenants, Conditions and Restrictions for Bentwater
66	06/05/98	9840772	Declaration of Covenants, Conditions & Restrictions Bentwater Section 66
66	11/16/00	2000-97722	Amendment to Clarify the Declarations of Covenants, Conditions & Restrictions For Bentwater
67	03/30/01	2001-025329	Declaration of Covenants, Conditions & Restrictions Bentwater Section 67
68	05/08/98	9833009	Declaration of Covenants, Conditions & Restrictions Bentwater Section 68

EXHIBIT "A"

68	11/16/00	2000-97722	Amendment to Clarify the Declarations of Covenants, Conditions. And Restrictions for Bentwater
70	04/26/01	2001-033865	Declaration of Covenants, Conditions & Restrictions Bentwater Section 70
71	04/01/99	99024599	Declaration of Covenants, Conditions & Restrictions Bentwater Section 71
71	11/16/00	2000-97722	Amendment to Clarify the Declarations of Covenants, Conditions. And Restrictions for Bentwater
72	08/04/99	99064883	Declaration of Covenants, Conditions & Restrictions Bentwater Section 72
72	02/03/00	2000-009582	First Amendment of Declaration of Covenants, Conditions & Restrictions Bentwater Section 72
72	11/16/00	2000-97722	Amendment to Clarify the Declarations of Covenants, Conditions. And Restrictions for Bentwater
74	07/24/03	2003-087732	Declaration of Covenants, Conditions & Restrictions Bentwater Section 74
75	12/13/99	99102953	Declaration of Covenants, Conditions & Restrictions Bentwater Section 75
75	11/16/00	2000-097725	Amendment to Clarify Declaration of Covenants, Conditions & Restrictions Bentwater Section 75
78	04/20/99	99030390	Declaration of Covenants, Conditions & Restrictions Bentwater Section 78
78	11/16/00	2000-97722	Amendment to Clarify the Declarations of Covenants, Conditions. And Restrictions for Bentwater
84	03/30/01	2001-025330	Declaration of Covenants, Conditions & Restrictions Bentwater Section 84
85	05/05/00	2000-037297	Declaration of Covenants, Conditions & Restrictions Bentwater Section 85
85	11/16/00	2000-97723	Amendment to Clarify the Declarations of Covenants, Conditions. And Restrictions for Bentwater
87	05/13/02	2002-047745	Declaration of Covenants, Conditions & Restrictions Bentwater Section 87

EXHIBIT "A"



88	05/07/04	2004-049025	Declaration of Covenants, Conditions & Restrictions Bentwater Section 88
89	06/13/03	2003-068069	Declaration of Covenants, Conditions & Restrictions Bentwater Section 89
92	03/01/05	2005-020170	Declaration of Covenants, Conditions & Restrictions Bentwater Section 92
93	03/01/05	2005-020169	Declaration of Covenants, Conditions & Restrictions Bentwater Section 93

R:\REAL\HOA\BENTPOA-1111\001\Exhibit A.doc

FILED FOR RECORD  
05 OCT 13 PM 1:44

*Mark Turnbull*  
COUNTY CLERK  
MONTGOMERY COUNTY, TEXAS

STATE OF TEXAS  
COUNTY OF MONTGOMERY

I hereby certify this instrument was filed in  
File Number Sequence on the date and at the time  
stamped herein by me and was duly RECORDED in  
the Official Public Records of Real Property at  
Montgomery County, Texas.

OCT 13 2005



*Mark Turnbull*

County Clerk  
Montgomery County, Texas

EXHIBIT "A"