



*Simply The Best!*

# Inspection Report

**Iris Velazquez**

**Property Address:**  
4011 Ivywood Dr  
Pearland TX 77584



**HG HOME INSPECTION**

**BYRON LEE Texas Professional Home Inspector TREC #23870  
2020 N Loop W  
Suite 150  
Houston, TX 77018**

# PROPERTY INSPECTION REPORT

---

**Prepared For:** Iris Velazquez  
(Name of Client)

**Concerning:** 4011 Ivywood Dr, Pearland, TX 77584  
(Address or Other Identification of Inspected Property)

**By:** BYRON LEE TREC #23870 / HG HOME INSPECTION 7/13/2021  
(Name and License Number of Inspector) (Date)

---

(Name, License Number of Sponsoring Inspector)

---

## PURPOSE, LIMITATIONS AND INSPECTOR / CLIENT RESPONSIBILITIES

This property inspection report may include an inspection agreement (contract), addenda, and other information related to property conditions. If any item or comment is unclear, you should ask the inspector to clarify the findings. It is important that you carefully read ALL of this information.

This inspection is subject to the rules ("Rules") of the Texas Real Estate Commission ("TREC"), which can be found at [www.trec.texas.gov](http://www.trec.texas.gov).

The TREC Standards of Practice (Sections 535.227-535.233 of the Rules) are the minimum standard for inspections by TREC Licensed inspectors. An inspection addresses only those components and conditions that are present, visible, and accessible at the time of the inspection. While there may be other parts, components or systems present, only those items specifically noted as being inspected were inspected. The inspector is NOT required to turn on decommissioned equipment, systems, utility services or apply an open flame or light a pilot to operate any appliance. The inspector is NOT required to climb over obstacles, move furnishings or stored items. The inspection report may address issues that are code-based or may refer to a particular code; however, this is NOT a code compliance inspection and does NOT verify compliance with manufacturer's installation instructions. The inspection does NOT imply insurability or warrantability of the structure or its components. Although some safety issues may be addressed in this report, this inspection is NOT a safety/code inspection, and the inspector is NOT required to identify all potential hazards.

In this report, the inspector shall indicate, by checking the appropriate boxes on the form, whether each item was inspected, not inspected, not present or deficient and explain the findings in the corresponding section in the body of the report form. The inspector must check the Deficient (D) box if a condition exists that adversely and materially affects the performance of a system or component or constitutes a hazard to life, limb or property as specified by the TREC Standards of Practice. General deficiencies include inoperability, material distress, water penetration, damage, deterioration, missing components, and unsuitable installation. Comments may be provided by the inspector whether or not an item is deemed deficient. The inspector is not required to prioritize or emphasize the importance of one deficiency over another.

Some items reported may be considered life-safety upgrades to the property. For more information, refer to Texas Real Estate Consumer Notice Concerning Recognized Hazards or Deficiencies below.

THIS PROPERTY INSPECTION IS NOT A TECHNICALLY EXHAUSTIVE INSPECTION OF THE STRUCTURE, SYSTEMS OR COMPONENTS. The inspection may not reveal all deficiencies. A real estate inspection helps to reduce some of the risk involved in purchasing a home, but it cannot eliminate these risks, nor can the inspection anticipate future events or changes in performance due to changes in use or occupancy. It is recommended that you obtain as much information as is available about this property, including any seller's disclosures, previous inspection reports, engineering reports, building/remodeling permits, and reports performed for or by relocation companies, municipal inspection departments, lenders, insurers, and appraisers.

---

Promulgated by the Texas Real Estate Commission(TREC) P.O. Box 12188, Austin, TX 78711-2188 (512)936-3000  
(<http://www.trec.state.tx.us>).

You should also attempt to determine whether repairs, renovation, remodeling, additions, or other such activities have taken place at this property. It is not the inspector's responsibility to confirm that information obtained from these sources is complete or accurate or that this inspection is consistent with the opinions expressed in previous or future reports.

ITEMS IDENTIFIED IN THE REPORT DO NOT OBLIGATE ANY PARTY TO MAKE REPAIRS OR TAKE OTHER ACTIONS, NOR IS THE PURCHASER REQUIRED TO REQUEST THAT THE SELLER TAKE ANY ACTION. When a deficiency is reported, it is the client's responsibility to obtain further evaluations and/or cost estimates from qualified service professionals. Any such follow-up should take place prior to the expiration of any time limitations such as option periods.

Evaluations by qualified tradesmen may lead to the discovery of additional deficiencies which may involve additional repair costs. Failure to address deficiencies or comments noted in this report may lead to further damage of the structure or systems and add to the original repair costs. The inspector is not required to provide follow-up services to verify that proper repairs have been made.

Property conditions change with time and use. For example, mechanical devices can fail at any time, plumbing gaskets and seals may crack if the appliance or plumbing fixture is not used often, roof leaks can occur at any time regardless of the apparent condition of the roof, and the performance of the structure and the systems may change due to changes in use or occupancy, effects of weather, etc. These changes or repairs made to the structure after the inspection may render information contained herein obsolete or invalid. This report is provided for the specific benefit of the client named above and is based on observations at the time of the inspection. If you did not hire the inspector yourself, reliance on this report may provide incomplete or outdated information. Repairs, professional opinions or additional inspection reports may affect the meaning of the information in this report. It is recommended that you hire a licensed inspector to perform an inspection to meet your specific needs and to provide you with current information concerning this property.

#### **TEXAS REAL ESTATE CONSUMER NOTICE CONCERNING HAZARDS OR DEFICIENCIES**

Each year, Texans sustain property damage and are injured by accidents in the home. While some accidents may not be avoidable, many other accidents, injuries, and deaths may be avoided through the identification and repair of certain hazardous conditions. Examples of such hazards include:

- malfunctioning, improperly installed, or missing ground fault circuit protection (GFCI) devices for electrical receptacles in garages, bathrooms, kitchens, and exterior areas;
- malfunctioning arc fault protection (AFCI) devices;
- ordinary glass in locations where modern construction techniques call for safety glass;
- malfunctioning or lack of fire safety features such as smoke alarms, fire-rated doors in certain locations, and functional emergency escape and rescue openings in bedrooms;
- malfunctioning carbon monoxide alarms;
- excessive spacing between balusters on stairways and porches;
- improperly installed appliances;
- improperly installed or defective safety devices;
- lack of electrical bonding and grounding; and
- lack of bonding on gas piping, including corrugated stainless steel tubing (CSST).

To ensure that consumers are informed of hazards such as these, the Texas Real Estate Commission (TREC) has adopted Standards of Practice requiring licensed inspectors to report these conditions as "Deficient" when performing an inspection for a buyer or seller, if they can be reasonably determined.

These conditions may not have violated building codes or common practices at the time of the construction of the home, or they may have been "grandfathered" because they were present prior to the adoption of codes prohibiting such conditions. While the TREC Standards of Practice do not require inspectors to perform a code compliance inspection, TREC considers the potential for injury or property loss from the hazards addressed in the Standards of Practice to be significant enough to warrant this notice.

Contract forms developed by TREC for use by its real estate licensees also inform the buyer of the right to have the home inspected and can provide an option clause permitting the buyer to terminate the contract within a specified time. Neither the Standards of Practice nor the TREC contract forms require a seller to remedy conditions revealed by an inspection. The decision to correct a hazard or any deficiency identified in an inspection report is left to the parties to the contract for the sale or purchase of the home.

INFORMATION INCLUDED UNDER "ADDITIONAL INFORMATION PROVIDED BY INSPECTOR", OR PROVIDED AS AN ATTACHMENT WITH THE STANDARD FORM, IS NOT REQUIRED BY THE COMMISSION AND MAY CONTAIN CONTRACTUAL TERMS BETWEEN THE INSPECTOR AND YOU, AS THE CLIENT. THE COMMISSION DOES NOT REGULATE CONTRACTUAL TERMS BETWEEN PARTIES. IF YOU DO NOT UNDERSTAND THE EFFECT OF ANY CONTRACTUAL TERM CONTAINED IN THIS SECTION OR ANY ATTACHMENTS, CONSULT AN ATTORNEY.

---

---

**ADDITIONAL INFORMATION PROVIDED BY INSPECTOR:**

**Standards of Practice:**

TREC Texas Real Estate Commission

**In Attendance:**

Vacant (inspector only)

**Type of building:**

Single Family (2 story)

**Style of Home:**

Traditional

**Approximate age of building:**

Over 25 Years

**Home Faces:**

SW

**Temperature:**

Over 65 (F) = 18 (C)

**Weather:**

Cloudy

**Ground/Soil surface condition:**

Damp

**Rain in last 3 days:**

Yes

Comments: Set by client/SS

Referral: Realtor

Rooms:

Utilities On: None

People Present at Inspection: Inspector



I = Inspected    NI = Not Inspected    NP = Not Present    D = Deficient

I   NI   NP   D

## I. STRUCTURAL SYSTEMS

The Home Inspector shall observe structural components including foundations, floors, walls, columns or piers, ceilings and roof. The home inspector shall describe the type of Foundation, floor structure, wall structure, columns or piers, ceiling structure, roof structure. The home inspector shall: Probe structural components where deterioration is suspected; Enter under floor crawl spaces, basements, and attic spaces except when access is obstructed, when entry could damage the property, or when dangerous or adverse situations are suspected; Report the methods used to observe under floor crawl spaces and attics; and Report signs of abnormal or harmful water penetration into the building or signs of abnormal or harmful condensation on building components. The home inspector is not required to: Enter any area or perform any procedure that may damage the property or its components or be dangerous to or adversely effect the health of the home inspector or other persons.

I = Inspected    NI = Not Inspected    NP = Not Present    D = Deficient

I   NI   NP   D



stick built roof structure



blown insulation 8 inches



vertical insulation 12 inches



roof surface

**A. Foundations**

**Type of Foundation (s):** Poured concrete

**Method used to observe Crawlspace:** No crawlspace

**Comments:**

(1) This is not an engineering report, but is only an opinion based on observation of conditions known to be

I = Inspected    NI = Not Inspected    NP = Not Present    D = Deficient

I   NI   NP   D

related to foundation performance, using the knowledge and experience of the inspector.

(2) The foundation is poured on grade and appears to be performing as designed.

(3) The foundation has large corner pop(s) that are larger than 4 inches. Further deterioration will occur if not corrected. I recommend having a qualified person make repairs as needed.



A. Item 1(Picture) garage right

(4) There are trees roots too close to the foundation. I recommend removal or the use of root diverters.

I = Inspected    NI = Not Inspected    NP = Not Present    D = Deficient

I   NI   NP   D



A. Item 2(Picture) right



A. Item 3(Picture) left

B. Grading and Drainage

[Comments:](#)

(1) There is a negative slope at the exterior areas and can cause or contribute to water intrusion or deterioration. I recommend correcting landscape to drain water away from home.



I = Inspected    NI = Not Inspected    NP = Not Present    D = Deficient

I   NI   NP   D



B. Item 1(Picture) right



B. Item 2(Picture) front



B. Item 3(Picture) left



B. Item 4(Picture) front



I = Inspected    NI = Not Inspected    NP = Not Present    D = Deficient

I   NI   NP   D

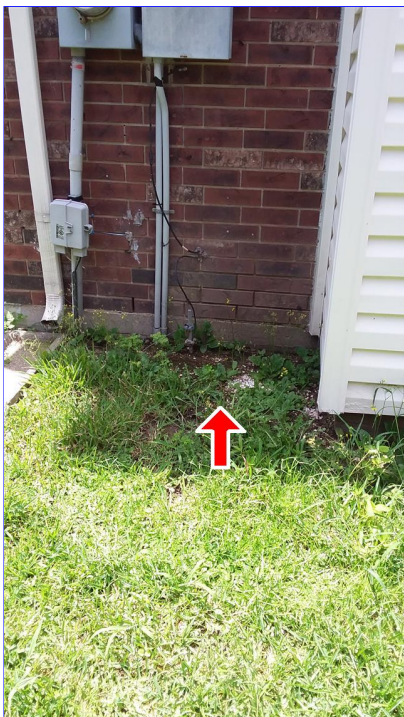

B. Item 5(Picture) left

(2) The landscape at the exterior may require a trench or drain if water stands or puddles after heavy rain. I am unable to determine due to no rain during inspection period.



B. Item 6(Picture) right



B. Item 7(Picture) left

(3) The gutter is damaged at the exterior. Gutters that drain poorly or clogged can lead to many costly

I = Inspected   NI = Not Inspected   NP = Not Present   D = Deficient

I   NI   NP   D

problems such as deterioration of fascia, soffit or roof edge. It can also cause gutters to pull loose and lead to possible water intrusion. A qualified person should repair or replace as needed.



B. Item 8(Picture) right



B. Item 9(Picture) left



B. Item 10(Picture) multiple areas

(4) Gutters are not properly secured to the home. Further deterioration or erosion can occur if not corrected. I recommend having a qualified person make repairs as needed.

I = Inspected    NI = Not Inspected    NP = Not Present    D = Deficient

I   NI   NP   D



B. Item 11(Picture) left



B. Item 12(Picture) rear

C. Roof Covering Materials

**Types of Roof Covering:** 3-Tab fiberglass

**Viewed from:** Ground, Binoculars

Extra Info: Aerial Photography

**Roof Ventilation:** Ridge vents, Soffit Vents, Passive

**Comments:**

(1) This inspection does not warrant against roof leaks.

(2) The upper eave of the roof line of the home is not accessible using a 17 foot ladder (the tallest ladder that can be safely moved and or climbed solo). All efforts were made to safely inspect the roofing surface using binoculars and aerial photography equipment. This limited the inspection to areas that were safely accessible and or visible at the time of inspection.

(3) The tree limbs that are in contact with roof or hanging near roof should be trimmed.



I = Inspected   NI = Not Inspected   NP = Not Present   D = Deficient

I   NI   NP   D



C. Item 1(Picture) front

(4) Kick out flashing is missing in areas of the roof. This is not considered today's standard. I recommend having a qualified roofing company make repairs as needed.



C. Item 2(Picture) left

I = Inspected    NI = Not Inspected    NP = Not Present    D = Deficient

|   |    |    |   |
|---|----|----|---|
| I | NI | NP | D |
|---|----|----|---|

(5) The flashing is loose and needs repair. I recommend having a qualified person make repairs as needed.

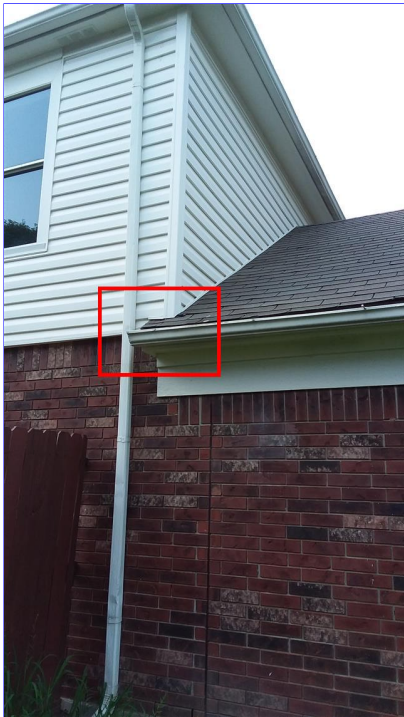

C. Item 3(Picture) left

(6) Shingles appear to be lifted in areas of the roof. Damage could occur if not corrected. I recommend having a qualified roofing contractor further evaluate and make repairs as needed.

I = Inspected    NI = Not Inspected    NP = Not Present    D = Deficient

I   NI   NP   D



C. Item 4(Picture) front



C. Item 5(Picture) front



C. Item 6(Picture) left

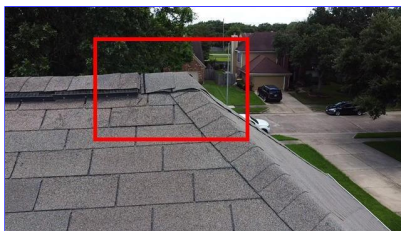

C. Item 7(Picture) rear left

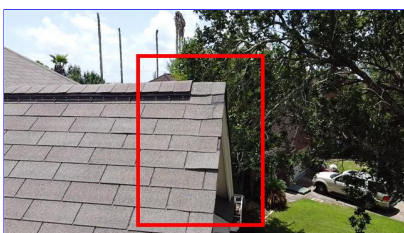

C. Item 8(Picture) multiple areas

(7) The roof covering is damaged in areas. These areas may need replacement and or periodic maintenance. A qualified roofing contractor should inspect and repair as needed.

I = Inspected    NI = Not Inspected    NP = Not Present    D = Deficient

| I | NI | NP | D |
|---|----|----|---|
|---|----|----|---|

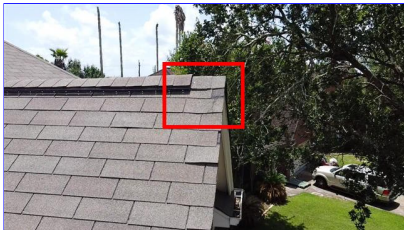

C. Item 9(Picture) front



C. Item 10(Picture) left

(8) The plumbing vent flashings appears to be defective. I recommend having a qualified roof professional make repairs as needed,



C. Item 11(Picture) rear

**D. Roof Structures and Attics**

**Method used to observe attic:** Walked

**Viewed from:** Attic

**Roof Structure:** Stick-built

**Attic Insulation:** Batt

**Approximate Average Depth of Insulation:** 8 inches

**Approximate Average Thickness of Vertical Insulation:** 12 inches

**Attic info:** Pull Down stairs

**Comments:**

- (1) Attic space inspected with limited access. This is for your information.
- (2) There were no insulation markers present at the time of the inspection. This is for your information.
- (3) The pull down stairs does not shut properly. This can cause some heat loss in winter and loss of cool air in summer if not corrected. A qualified contractor should inspect and repair as needed.

I = Inspected    NI = Not Inspected    NP = Not Present    D = Deficient

| I | NI | NP | D |
|---|----|----|---|
|---|----|----|---|



D. Item 1(Picture) garage

(4) The pull down stairs are not properly insulated. This can cause some heat loss in winter and loss of cool air in summer if not corrected. I recommend repair as desired.



D. Item 2(Picture) garage



D. Item 3(Picture) interior



I = Inspected    NI = Not Inspected    NP = Not Present    D = Deficient

I   NI   NP   D

(5) The pull down stairs are weak and not stable. Injury could result if not repaired. A qualified person should repair or replace as needed.



D. Item 4(Picture) interior

(6) The attic space has areas of missing insulation. This is causing energy loss and is not today's standard. I recommend having a qualified person evaluate and add insulation as needed.

I = Inspected    NI = Not Inspected    NP = Not Present    D = Deficient

I   NI   NP   D



D. Item 5(Picture) garage attic

(7) The attic space has areas of thin insulation. This is causing energy loss and is not today's standard. I recommend having a qualified person evaluate and add insulation as needed.



D. Item 6(Picture) upper attic



D. Item 7(Picture) upper attic

I = Inspected    NI = Not Inspected    NP = Not Present    D = Deficient

| I | NI | NP | D |
|---|----|----|---|
|---|----|----|---|

(8) There decking has been patched in the attic space. I recommend having a qualified person evaluate and repair as needed.



D. Item 8(Picture) garage attic

(9) The roof structure in the attic has water stain indicating a leak did or still exists in areas. A qualified contractor should inspect and repair as needed.



I = Inspected   NI = Not Inspected   NP = Not Present   D = Deficient

I   NI   NP   D



D. Item 9(Picture) garage attic right



D. Item 10(Picture) rear right

(10) There are some dips or sags in the roof in areas. This is typical of older construction where possibly the rafters were undersized and created a sag. A qualified contractor should repair as needed.



D. Item 11(Picture) front

E. Walls (Interior and Exterior)

**Wall Structure:** Wood

**Comments:**

(1) Areas where wiring or piping passes through walls should be sealed. I recommend having a qualified person seal as needed.

I = Inspected   NI = Not Inspected   NP = Not Present   D = Deficient

I   NI   NP   D



E. Item 1(Picture) left



E. Item 2(Picture) exterior lights



E. Item 3(Picture) rear

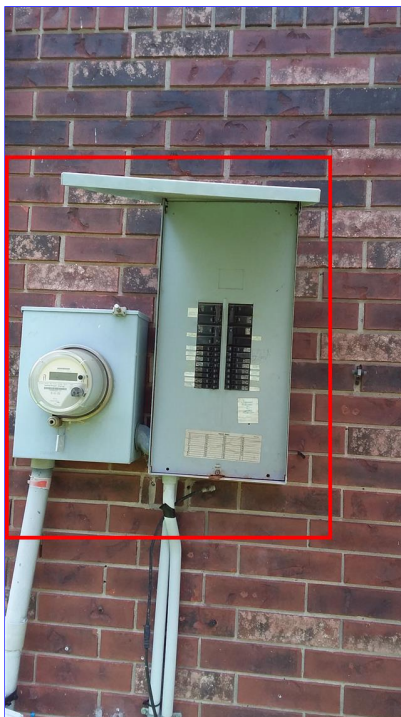

E. Item 4(Picture) left

(2) The paint is failing. I recommend prep and paint at the exterior.

I = Inspected   NI = Not Inspected   NP = Not Present   D = Deficient

I   NI   NP   D



E. Item 5(Picture) garage

(3) Lintels above exterior doors are showing signs of deterioration. Further deterioration may occur if lintels are not primed and painted. A qualified person should repair as needed.



E. Item 6(Picture) entry

(4) The brick siding at the exterior has hairline cracks. Deterioration can eventually occur if not corrected. A qualified contractor should inspect and repair as needed.



I = Inspected    NI = Not Inspected    NP = Not Present    D = Deficient

I   NI   NP   D



E. Item 7(Picture) right

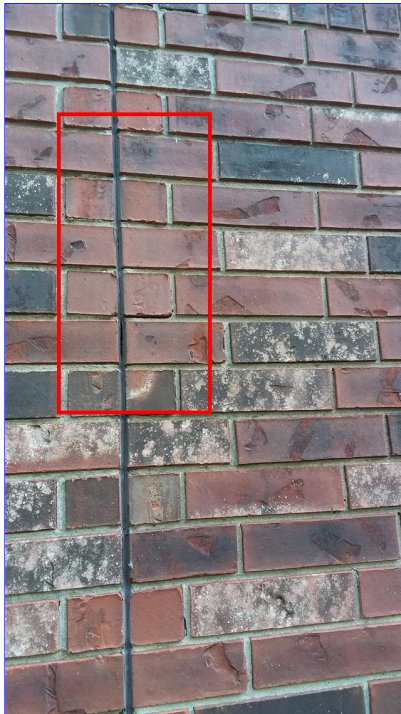

E. Item 8(Picture) right

(5) The brick siding at the exterior of the home has expansion joint sealant that is weathered or missing. Further deterioration can occur if not corrected. A qualified person should repair or replace as needed.



E. Item 9(Picture) right

I = Inspected    NI = Not Inspected    NP = Not Present    D = Deficient

| I | NI | NP | D |
|---|----|----|---|
|---|----|----|---|

(6) The exterior siding and trim is deteriorated in areas. Further deterioration will occur if not corrected. A qualified contractor should inspect and repair as needed.

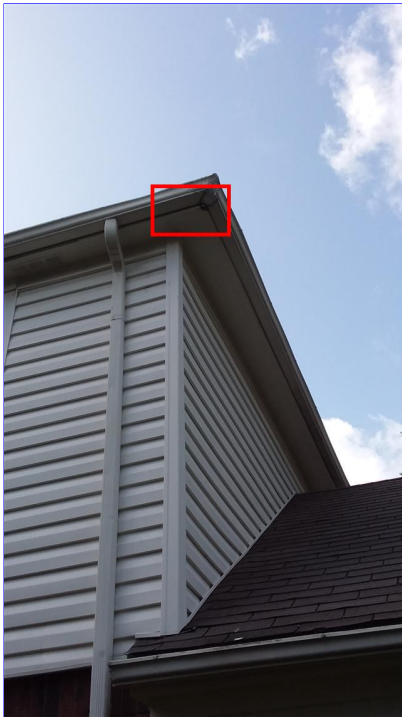

E. Item 10(Picture) left

(7) The vinyl siding exterior is damaged. Further deterioration can occur if not corrected. A qualified person should repair or replace as needed.

I = Inspected   NI = Not Inspected   NP = Not Present   D = Deficient

I   NI   NP   D



E. Item 11(Picture) left



E. Item 12(Picture) left

(8) Baseboards have some separation and deterioration of caulking. I recommend having a qualified person make repairs of needed.



E. Item 13(Picture) entry



E. Item 14(Picture) multiple areas



I = Inspected   NI = Not Inspected   NP = Not Present   D = Deficient

| I | NI | NP | D |
|---|----|----|---|
|---|----|----|---|

F. Ceilings and Floors

**Floor Structure:** Slab  
**Floor System Insulation:** NONE  
**Ceiling Structure:** 6" or better

**Comments:**

(1) The Vinyl was not installed according to standard workmanlike practices at the in areas. This damage is considered cosmetic. A qualified person should repair or replace as needed.



F. Item 1(Picture) hallway upstairs

(2) The drywall on the ceiling has several hairline cracks (cosmetic) in areas. This damage is considered cosmetic. A qualified person should repair or replace as needed.

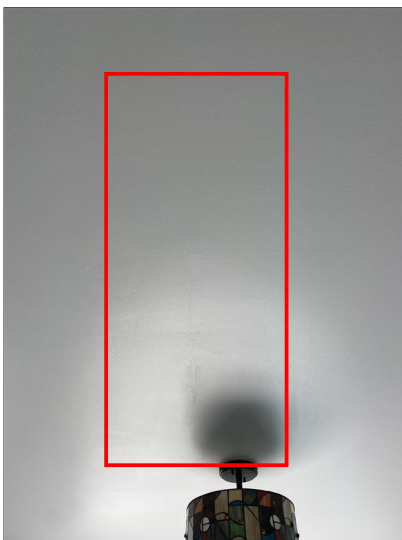

F. Item 2(Picture) breakfast area

(3) The drywall on the ceiling has some "nail pops," (cosmetic). While this damage is cosmetic, it needs to be repaired. A qualified contractor should inspect and repair as needed.

I = Inspected   NI = Not Inspected   NP = Not Present   D = Deficient

| I | NI | NP | D |
|---|----|----|---|
|---|----|----|---|

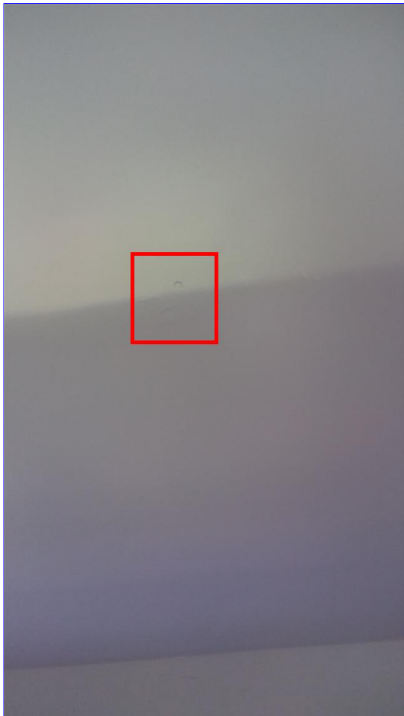

F. Item 3(Picture) primary bedroom

**G. Doors (Interior and Exterior)**

[Comments:](#)

(1) The garage door at the front of home is damaged at panel. This is a maintenance issue and is for your information. A qualified person should repair or replace as needed.



I = Inspected    NI = Not Inspected    NP = Not Present    D = Deficient

I   NI   NP   D



G. Item 1(Picture) middle

(2) The garage door at the front of home is deteriorated at panel. This is a maintenance issue and is for your information. A qualified person should repair or replace as needed.



G. Item 2(Picture) lower panel

(3) There are door stops missing in the home. This is not considered to be today's standard I recommend having a qualified person make repairs as needed.

I = Inspected    NI = Not Inspected    NP = Not Present    D = Deficient

|   |    |    |   |
|---|----|----|---|
| I | NI | NP | D |
|---|----|----|---|



G. Item 3(Picture) entry closet

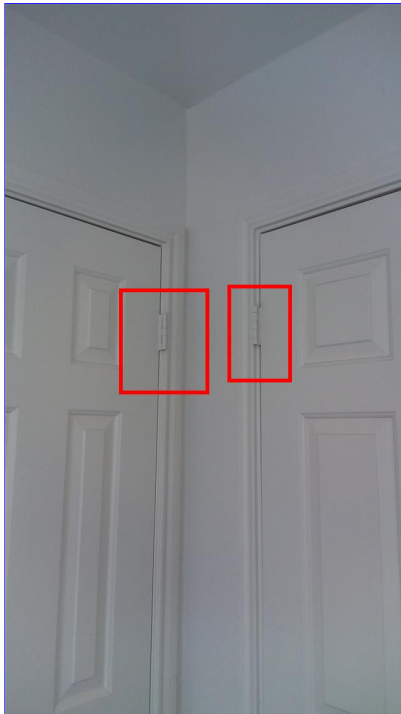

G. Item 4(Picture) multiple areas

(4) The exterior door has keyed dead bolt lock. This prevents proper egress and is a safety hazard until repaired. I recommend having a qualified person make repairs as needed.



G. Item 5(Picture) garage

I = Inspected    NI = Not Inspected    NP = Not Present    D = Deficient

I   NI   NP   D

(5) The main entry door has a pet access door installed. This is a maintenance issue and is for your information. A qualified person should repair or replace as needed.



G. Item 6(Picture) garage entry

(6) The main entry door reveals daylight when latched at areas missing weather-stripping. This can cause some heat loss in winter and loss of cool air in summer if not corrected. A qualified person should repair or replace as needed.

I = Inspected    NI = Not Inspected    NP = Not Present    D = Deficient

I   NI   NP   D



G. Item 7(Picture) patio

(7) The interior garage door does not have the required self closing hinge. This is not considered to be today's standard. I recommend having a qualified person make repairs as needed.



G. Item 8(Picture)

I = Inspected    NI = Not Inspected    NP = Not Present    D = Deficient

|   |    |    |   |
|---|----|----|---|
| I | NI | NP | D |
|---|----|----|---|

(8) The interior door is damaged in areas. This is cosmetic and for your information. A qualified person should repair or replace as needed.

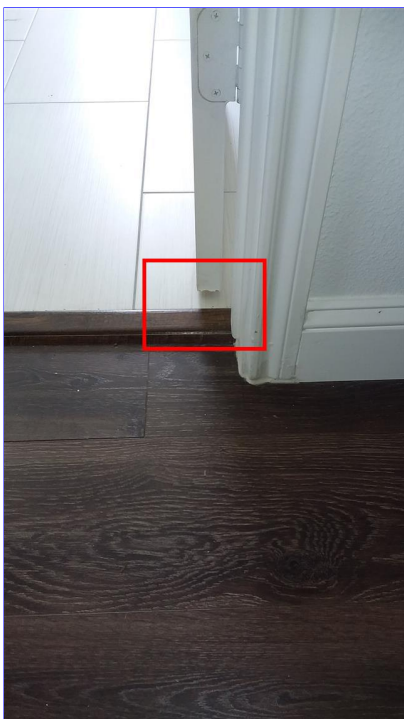

G. Item 9(Picture) hall bath

H. Windows

Comments:

(1) Lintels above windows are showing signs of deterioration in areas. Further deterioration may occur if lintels are not primed and painted. A qualified person should repair as needed.



H. Item 1(Picture) front

(2) There are windows in required tempered glass areas that are missing the required markings. This is not considered to be today's standard and is a safety hazard until glass is confirmed to be and marked tempered. I recommend having glass professional evaluate and mark or replace as needed.

I = Inspected    NI = Not Inspected    NP = Not Present    D = Deficient

I   NI   NP   D



H. Item 2(Picture) primary bath



H. Item 3(Picture) entry

(3) Window does not have proper clearance from flooring in upstairs bedroom. A fall or injury could occur. This is for your information.

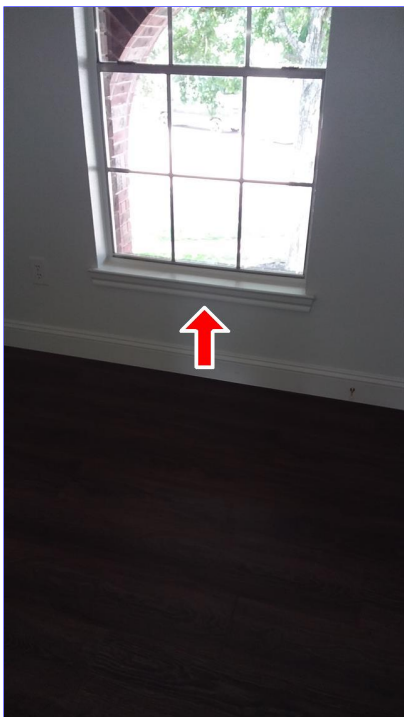

H. Item 4(Picture) front bedroom



H. Item 5(Picture) all bedrooms



I = Inspected   NI = Not Inspected   NP = Not Present   D = Deficient

I   NI   NP   D

(4) Windows have damaged or missing screens. This is not considered to be today's standards. I recommend having a qualified person make repairs as needed.



H. Item 6(Picture) front



H. Item 7(Picture) multiple windows

(5) There are window frames that are not properly sealed. This can cause energy loss. I recommend having a qualified person seal and repair as needed.

I = Inspected    NI = Not Inspected    NP = Not Present    D = Deficient

I   NI   NP   D



H. Item 8(Picture) front



H. Item 9(Picture) multiple windows

(6) Some windows do not lock properly in areas. This is a maintenance issue and is for your information. A qualified person should repair or replace as needed.



H. Item 10(Picture) rear right bedroom



I = Inspected    NI = Not Inspected    NP = Not Present    D = Deficient

| I | NI | NP | D |
|---|----|----|---|
|---|----|----|---|

I. Stairways (Interior and Exterior)

Comments:

J. Fireplaces and Chimneys

**Chimney (exterior):** Cement Fiber

**Operable Fireplaces:** One

**Types of Fireplaces:** Gas/LP Log starter

**Number of Woodstoves:** None

Comments:

- (1) I do not inspect the shape of fireplace or the design to determine if your fireplace has a proper air draw.
- (2) Metal rain cap on chimney crown is rusting. I recommend repair by a qualified person.



J. Item 1(Picture)

- (3) The flue pipe was partially visible and appeared good, but due to creosote build-up we could not inspect for cracks. I recommend a licensed chimney sweep clean and inspect for safety.



J. Item 2(Picture)

- (4) The (Burn Area) for the fireplace at the living room is not properly sealed. This burn area should be fireproof. Any repairs should be performed according to the manufacturer's specifications.

I = Inspected    NI = Not Inspected    NP = Not Present    D = Deficient

I   NI   NP   D



J. Item 3(Picture) seal gap at gas line

**K. Porches, Balconies, Decks and Carports**

[Comments:](#)

The weight load capabilities are not part of this inspection.

**L. Other**

[Comments:](#)

(1) Areas of the home have caulking or grout missing or damaged. Deterioration could occur if not corrected. I recommend having a qualified contractor inspect and make repairs as needed.

I = Inspected    NI = Not Inspected    NP = Not Present    D = Deficient

I   NI   NP   D



L. Item 1(Picture) primary bath



L. Item 2(Picture) hall bath



L. Item 3(Picture) multiple areas

(2) The concrete walkway at the exterior areas has settlement cracks. Further deterioration can occur if not repaired. A qualified person should repair or replace as needed.

I = Inspected    NI = Not Inspected    NP = Not Present    D = Deficient

I   NI   NP   D



L. Item 4(Picture) driveway



L. Item 5(Picture) driveway

(3) There is what appears to be an active insect colony. I recommend contacting a qualified pest control company to inspect and treat as needed.



L. Item 6(Picture) right

(4) There is debris stacked against the structure creating conducive conditions for certain types wood



I = Inspected   NI = Not Inspected   NP = Not Present   D = Deficient

I   NI   NP   D

destroying insects. I recommend removal of debris and having a qualified pest control company inspect and treat as needed.

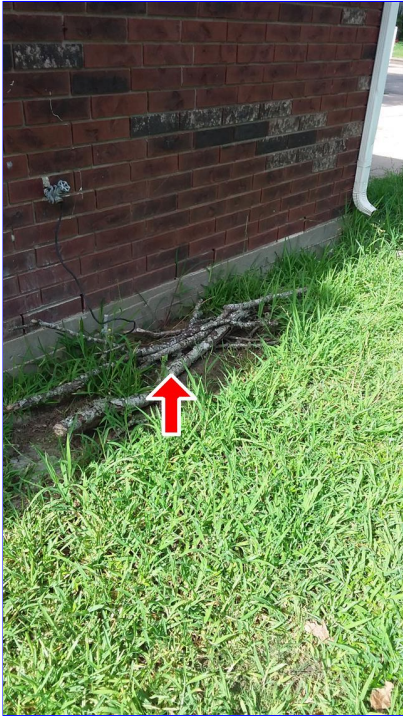

L. Item 7(Picture) left

(5) The landscape walkway at the front of home is uneven and can be a tripping hazard. A fall or injury can occur if not corrected. A qualified person should repair or replace as needed.



L. Item 8(Picture) rear

I = Inspected    NI = Not Inspected    NP = Not Present    D = Deficient

I   NI   NP   D

(6) There are bricks stacked against the foundation wall creating conducive conditions for certain types wood destroying insects. I recommend having a qualified pest control company inspect and treat as needed.



L. Item 9(Picture) rear left

---

The structure of the home was inspected and reported on with the above information. While the inspector makes every effort to find all areas of concern, some areas can go unnoticed. Please be aware that the inspector has your best interest in mind. Any repair items mentioned in this report should be considered before purchase. It is recommended that qualified contractors be used in your further inspection or repair issues as it relates to the comments in this inspection report.

I = Inspected    NI = Not Inspected    NP = Not Present    D = Deficient

I   NI   NP   D

## II. ELECTRICAL SYSTEMS

The home inspector shall observe: Service entrance conductors; Service equipment, grounding equipment, main over current device, and main and distribution panels; Amperage and voltage ratings of the service; Branch circuit conductors, their over current devices, and the compatibility of their ampacities and voltages; The operation of a representative number of installed ceiling fans, lighting fixtures, switches and receptacles located inside the house, garage, and on the dwelling's exterior walls; The polarity and grounding of all receptacles within six feet of interior plumbing fixtures, and all receptacles in the garage or carport, and on the exterior of inspected structures; The operation of ground fault circuit interrupters; and Smoke detectors. The home inspector shall describe: Service amperage and voltage; Service entry conductor materials; Service type as being overhead or underground; and Location of main and distribution panels. The home inspector shall report any observed aluminum branch circuit wiring. The home inspector shall report on presence or absence of smoke detectors, and operate their test function, if accessible, except when detectors are part of a central system. The home inspector is not required to: Insert any tool, probe, or testing device inside the panels; Test or operate any over current device except ground fault circuit interrupters; Dismantle any electrical device or control other than to remove the covers of the main and auxiliary distribution panels; or Observe: Low voltage systems; Security system devices, heat detectors, or carbon monoxide detectors; Telephone, security, cable TV, intercoms, or other ancillary wiring that is not a part of the primary electrical distribution system; or Built-in vacuum equipment.



service panel exterior left 100 amp

**A. Service Entrance and Panels**

**Electrical Service Conductors:** Below ground

**Panel Capacity:** 100 AMP

**Panel Type:** Circuit breakers

**Electric Panel Manufacturer:** General Electric

**Comments:**

(1) The grounding rod near meter is using improper clamp for grounding of main panel (solid brass clamp is recommended). This is not considered to be today's standard. I recommend having a qualified person replace with proper clamp to assure proper grounding.

I = Inspected    NI = Not Inspected    NP = Not Present    D = Deficient

I   NI   NP   D



A. Item 1(Picture) left



A. Item 2(Picture)

(2) Some labels are present, but are illegible or confusing. I recommend correcting for safety reasons.



A. Item 3(Picture)

(3) The panel is missing cover screw(s). **This is a safety issue.** I recommend having a qualified person repair as needed.



I = Inspected    NI = Not Inspected    NP = Not Present    D = Deficient

I   NI   NP   D

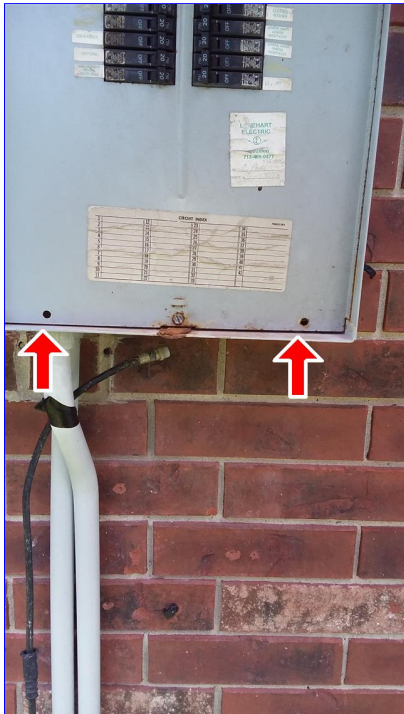

A. Item 4(Picture)

(4) The panel is showing deterioration and is not sealed properly. Electrical issues are considered a hazard until repaired. I recommend having a qualified person make repair or replace as needed.

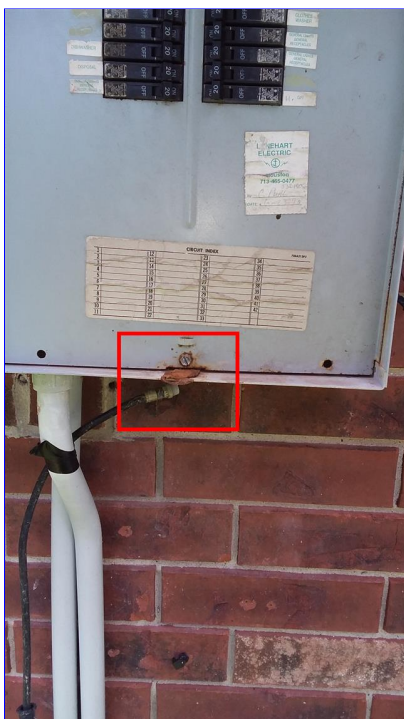

A. Item 5(Picture) left

I = Inspected    NI = Not Inspected    NP = Not Present    D = Deficient

| I | NI | NP | D |
|---|----|----|---|
|---|----|----|---|

**B. Branch Circuits, Connected Devices, and Fixtures**

**Type of Wiring:** Romex

**Branch wire 15 and 20 amperage:** Copper

**Comments:**

(1) I recommend checking all smoke detectors for functionality and putting fresh batteries in each unit upon move in. It is recommend to have smoke detection in each bedroom, hallways and living area. (Carbon monoxide detection is recommended if home is equipped with gas fired appliances)

(2) Problem(s) discovered with Branch Circuits such as amateur wiring installation, doubled wiring at neutral/grounding bar and any other problems that an electrical contractor may discover while performing repairs need correcting. I recommend a licensed electrical contractor inspect further and correct as needed.

I = Inspected    NI = Not Inspected    NP = Not Present    D = Deficient

| I | NI | NP | D |
|---|----|----|---|
|---|----|----|---|

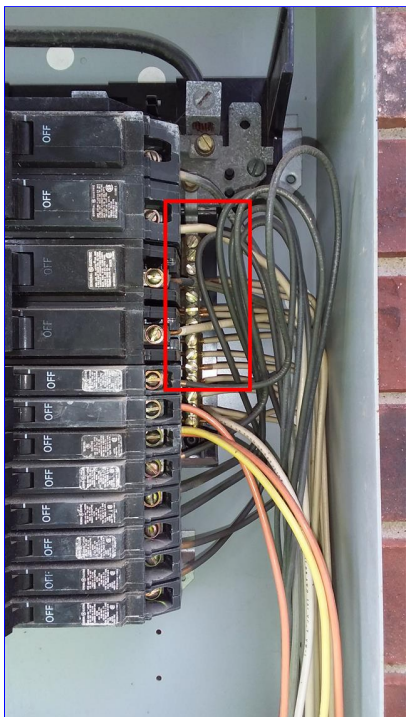

B. Item 1(Picture) wires double lugged

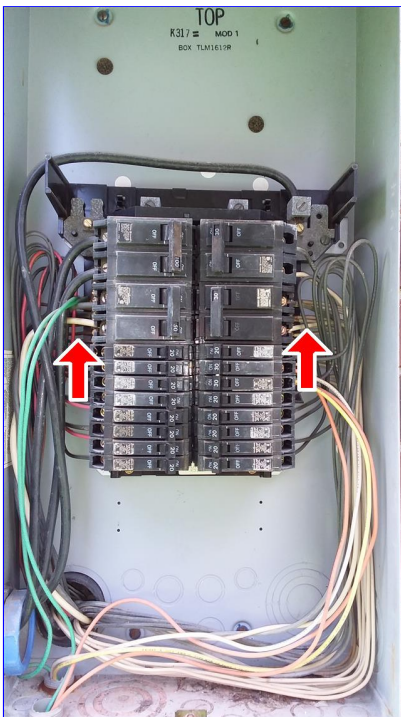

B. Item 2(Picture) mark white wires black

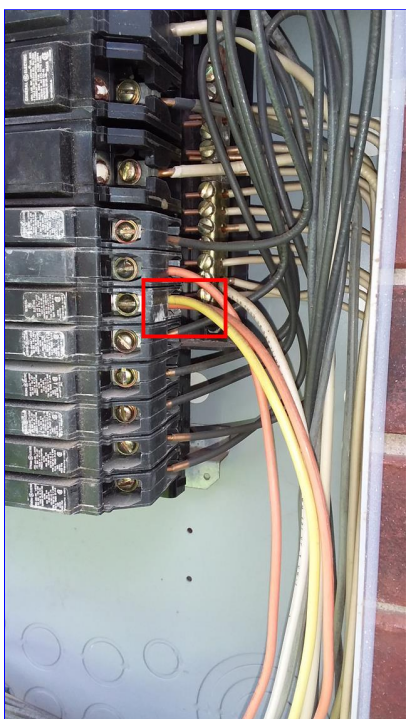

B. Item 3(Picture) double tapped breaker

(3) Arc fault breakers are not in required areas of home at electrical panel. This is not considered today's standard. I recommend having a qualified electrician inspect and make repairs as needed.

I = Inspected    NI = Not Inspected    NP = Not Present    D = Deficient

I   NI   NP   D

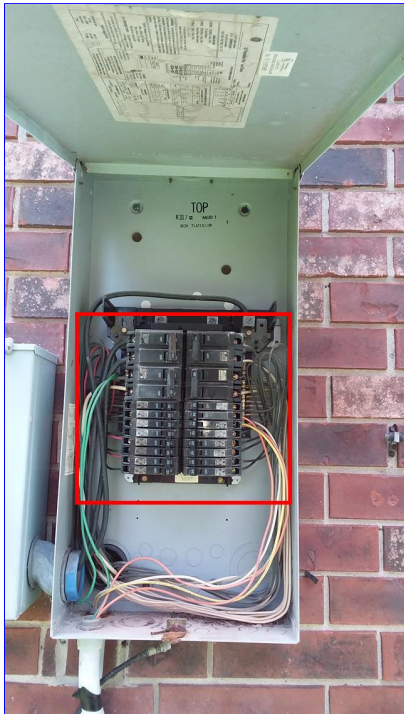

B. Item 4(Picture)

(4) There is an extension cord being used as permanent wiring and needs to be properly wired or removed.



B. Item 5(Picture) above microwave



I = Inspected   NI = Not Inspected   NP = Not Present   D = Deficient

I   NI   NP   D

(5) There is exposed wiring in areas of the home. This is a safety hazard. I recommend having a qualified electrician inspect and make repairs as needed.

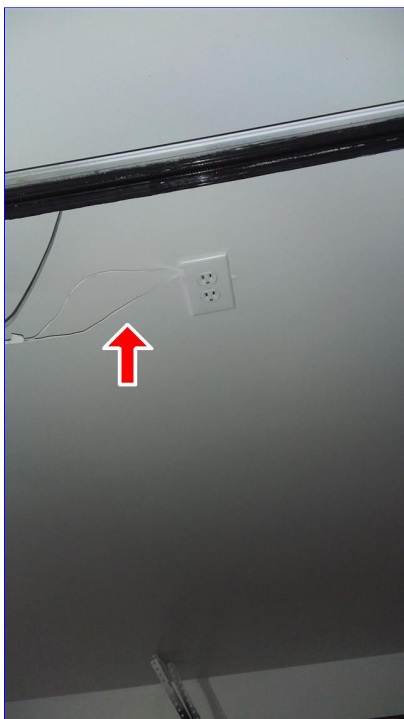

B. Item 6(Picture) garage

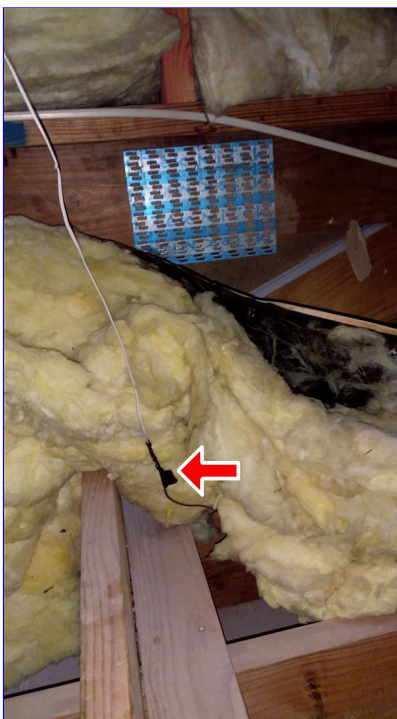

B. Item 7(Picture) garage attic



B. Item 8(Picture) upper attic

(6) The electrical wiring in attic was not secured to wood members properly and was not installed neatly or

I = Inspected    NI = Not Inspected    NP = Not Present    D = Deficient

I   NI   NP   D

in 90 degree turns as in standard workmanlike practice. This may indicate that a licensed electrical contractor did not perform the work or did not follow standards (for your information).



B. Item 9(Picture) garage attic

(7) The ceiling fan "wobbles". Some fans that wobble cannot be corrected without replacement. A qualified licensed electrical contractor should perform repairs that involve wiring.

I = Inspected    NI = Not Inspected    NP = Not Present    D = Deficient

I   NI   NP   D



B. Item 10(Picture) living room



B. Item 11(Picture) primary bedroom



B. Item 12(Picture) multiple areas

(8) The light fixture does not work (try bulb first). Electrical issues are considered a hazard until repaired. A qualified licensed electrical contractor should perform repairs that involve wiring.

I = Inspected   NI = Not Inspected   NP = Not Present   D = Deficient

I   NI   NP   D



B. Item 13(Picture) front



B. Item 14(Picture) patio

(9) The light fixture is loose in areas. Electrical issues are considered a hazard until repaired. A qualified licensed electrical contractor should perform repairs that involve wiring.



B. Item 15(Picture) entry lights



I = Inspected    NI = Not Inspected    NP = Not Present    D = Deficient

I   NI   NP   D

(10) The wall switch purpose is unknown (could not identify) in areas. This is for your information. A qualified licensed electrical contractor should perform repairs that involve wiring.



B. Item 16(Picture) dining room left

(11) There are no GFCI protected circuits in required areas. This is not considered to be today's standard. I recommend having a qualified electrician make repairs as needed.

I = Inspected    NI = Not Inspected    NP = Not Present    D = Deficient

I   NI   NP   D



B. Item 17(Picture) entry



B. Item 18(Picture) kitchen

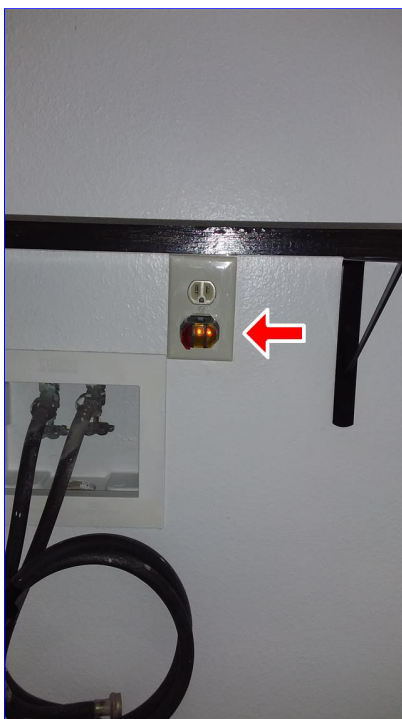

B. Item 19(Picture) laundry room

(12) The outlet cover is damaged and needs replaced. I recommend having a qualified person make repairs as needed.

I = Inspected    NI = Not Inspected    NP = Not Present    D = Deficient

I   NI   NP   D



B. Item 20(Picture) front right bedroom

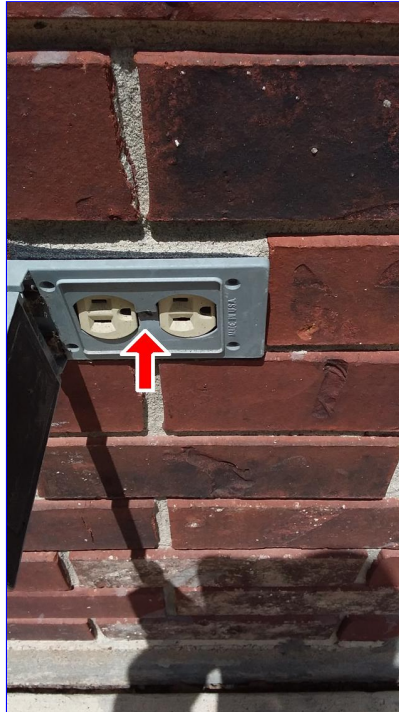

B. Item 21(Picture) patio

(13) "Three-prong" outlets are loose in wall. Electrical issues are considered a hazard until repaired. A qualified licensed electrical contractor should perform repairs that involve wiring.

I = Inspected    NI = Not Inspected    NP = Not Present    D = Deficient

| I | NI | NP | D |
|---|----|----|---|
|---|----|----|---|



B. Item 22(Picture) entry



B. Item 23(Picture) dining room



B. Item 24(Picture) multiple outlets

(14) "Three-prong" outlets are broken or damaged. Electrical issues are considered a hazard until repaired. A qualified licensed electrical contractor should perform repairs that involve wiring.



I = Inspected    NI = Not Inspected    NP = Not Present    D = Deficient

I   NI   NP   D



B. Item 25(Picture) breakfast area    B. Item 26(Picture) multiple areas

(15) "Three-prong" outlets are not working in the garage. Electrical issues are considered a hazard until repaired. A qualified licensed electrical contractor should perform repairs that involve wiring.



B. Item 27(Picture) rear

I = Inspected    NI = Not Inspected    NP = Not Present    D = Deficient

| I | NI | NP | D |
|---|----|----|---|
|---|----|----|---|

(16) "Three-prong" outlets have been painted in most if not all rooms. This is for your information. A qualified licensed electrical contractor should perform repairs that involve wiring.

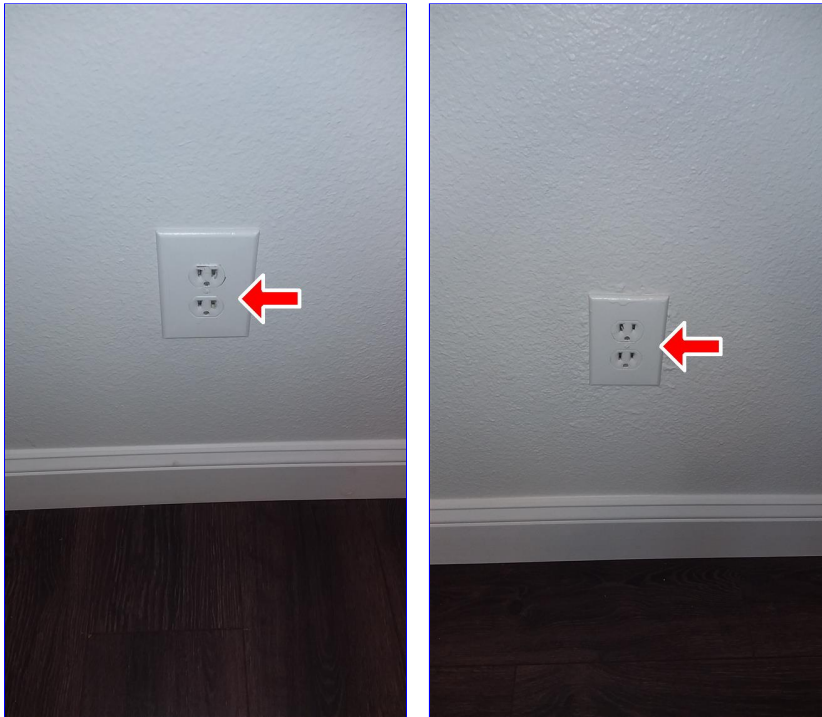

B. Item 28(Picture) front bedroom    B. Item 29(Picture) all rooms

(17) The exterior outlet at the rear of home did not work or there is no power to outlet. Electrical issues are considered a hazard until repaired. A qualified licensed electrical contractor should perform repairs that involve wiring.

I = Inspected    NI = Not Inspected    NP = Not Present    D = Deficient

I   NI   NP   D



B. Item 30(Picture) patio

The electrical system of the home was inspected and reported on with the above information. While the inspector makes every effort to find all areas of concern, some areas can go unnoticed. Outlets were not removed and the inspection was only visual. Any outlet not accessible (behind the refrigerator for example) was not inspected or accessible. Please be aware that the inspector has your best interest in mind. Any repair items mentioned in this report should be considered before purchase. It is recommended that qualified contractors be used in your further inspection or repair issues as it relates to the comments in this inspection report.

I = Inspected    NI = Not Inspected    NP = Not Present    D = Deficient

I   NI   NP   D

### III. HEATING, VENTILATION AND AIR CONDITIONING SYSTEMS

The home inspector shall observe permanently installed heating and cooling systems including: Heating equipment; Cooling Equipment that is central to home; Normal operating controls; Automatic safety controls; Chimneys, flues, and vents, where readily visible; Solid fuel heating devices; Heat distribution systems including fans, pumps, ducts and piping, with supports, insulation, air filters, registers, radiators, fan coil units, convectors; and the presence of an installed heat source in each room. The home inspector shall describe: Energy source; and Heating equipment and distribution type. The home inspector shall operate the systems using normal operating controls. The home inspector shall open readily openable access panels provided by the manufacturer or installer for routine homeowner maintenance. The home inspector is not required to: Operate heating systems when weather conditions or other circumstances may cause equipment damage; Operate automatic safety controls; Ignite or extinguish solid fuel fires; or Observe: The interior of flues; Fireplace insert flue connections; Humidifiers; Electronic air filters; or The uniformity or adequacy of heat supply to the various rooms.



I = Inspected NI = Not Inspected NP = Not Present D = Deficient

I NI NP D



ac data plate



ac data plate



ac units exterior rear

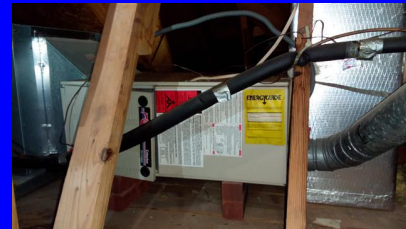

gas furnace attic

I = Inspected    NI = Not Inspected    NP = Not Present    D = Deficient

I   NI   NP   D



gas furnace attic



insulated ducts attic

**A. Heating Equipment**

**Type of Systems:** Forced Air

**Energy Sources:** Gas

**Heat System Brand:** Rheem

**Number of Heat Systems (excluding wood):** Two

**Comments:**

- (1) It is recommend to have heating systems serviced annually.
- (2) The heat exchangers on a gas furnace can not be completely examined with out removal of front cover. I recommend having heating system serviced by HVAC professional before use and annually.
- (3) Tested and working properly at the time of inspection.

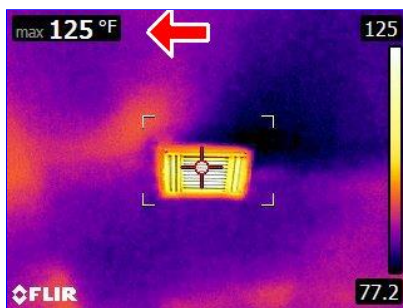

A. Item 1(Picture)

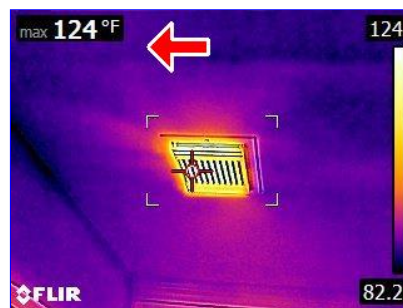

A. Item 2(Picture)

- (4) The gas furnace has a loose cover. This is a maintenance issue and should be repaired. I recommend service or repair as needed.

I = Inspected    NI = Not Inspected    NP = Not Present    D = Deficient

I   NI   NP   D



A. Item 3(Picture) front unit



A. Item 4(Picture) rear unit

(5) The gas furnace is installed without the recommended sediment trap or "drip leg" that is designed to extend the life of the unit. This is not considered to be today's standard. I recommend having a qualified person make repairs as needed.

I = Inspected   NI = Not Inspected   NP = Not Present   D = Deficient

I   NI   NP   D

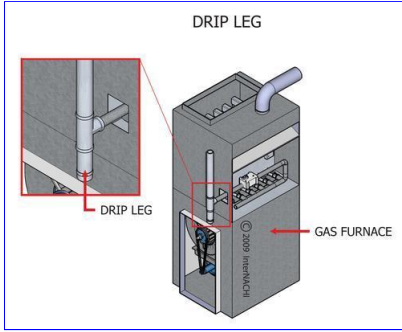

A. Item 5(Picture) dripleg



A. Item 6(Picture) front unit



A. Item 7(Picture) rear unit

B. Cooling Equipment

**Type of Systems:** Air conditioner unit

**Central Air Manufacturer:** American Standard, Goodman

**Comments:**



I = Inspected    NI = Not Inspected    NP = Not Present    D = Deficient

| I | NI | NP | D |
|---|----|----|---|
|---|----|----|---|

(1) It is recommended to have HVAC systems serviced annually.  
(2) The ambient air test was performed by using infrared thermal equipment at the supply vents of both Air conditioners to determine if the difference in temperatures of the supply and return air are between 14 degrees and 22 degrees which indicates that the unit is cooling as intended. The supply air temperature on your system read 61 degrees on one unit and on the other one read 71 degrees. The return air temperature was 74 degrees on one unit and on the other one read 78 degrees. This indicates that both units are **not** cooling properly and a licensed Heat/Air contractor should inspect for cause or problem.

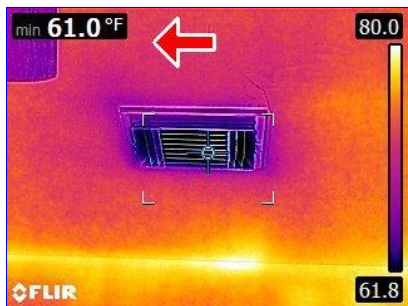

B. Item 1(Picture) supply

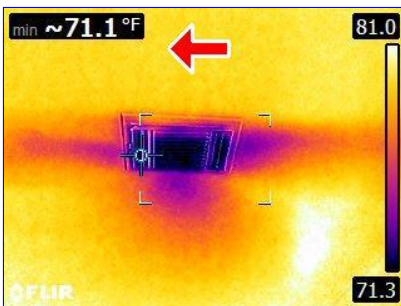

B. Item 2(Picture) supply

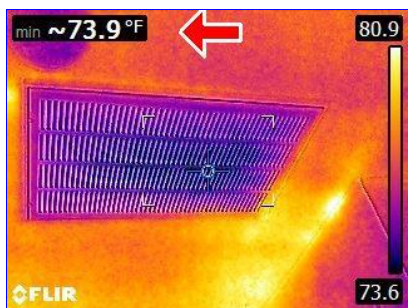

B. Item 3(Picture) return



B. Item 4(Picture) return

(3) The emergency overflow drain pan for the HVAC system is showing signs of deterioration. Further deterioration may occur if not corrected. I recommend having a qualified person make repairs as needed.

I = Inspected    NI = Not Inspected    NP = Not Present    D = Deficient

I   NI   NP   D



B. Item 5(Picture) front unit

(4) The air handler is missing foam sleeve in area(s). A replacement is needed. I recommend service or repair as needed.

I = Inspected    NI = Not Inspected    NP = Not Present    D = Deficient

|   |    |    |   |
|---|----|----|---|
| I | NI | NP | D |
|---|----|----|---|



B. Item 6(Picture) front unit

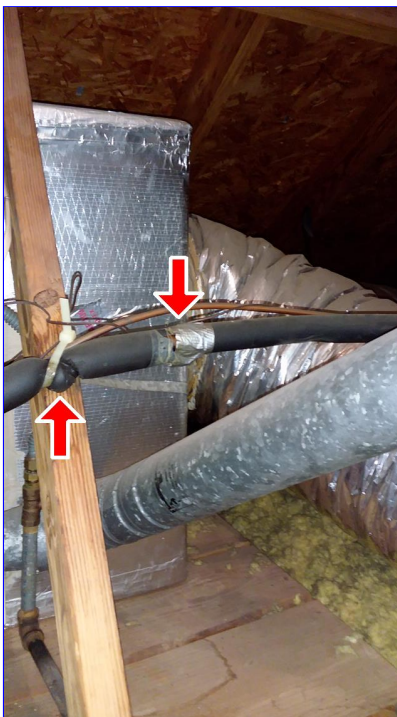

B. Item 7(Picture) front unit



B. Item 8(Picture) rear unit

(5) Signs of fungi growth is present on ductwork or furnace in the attic space. This could indicate that furnace may not be sealed properly. We did not inspect, test or determine if this growth is or is not a health hazard. The underlying cause is moisture. I recommend having the unit serviced and properly cleaned.

I = Inspected    NI = Not Inspected    NP = Not Present    D = Deficient

I   NI   NP   D



B. Item 9(Picture) front unit

(6) The condenser is missing foam sleeve in area(s). A replacement is needed. I recommend service or repair as needed.

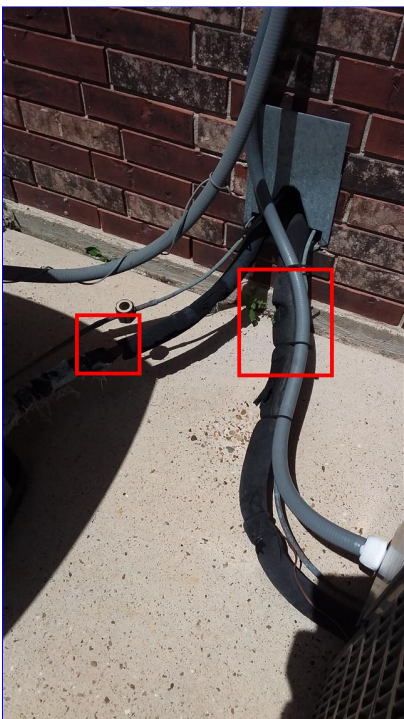

B. Item 10(Picture) rear



I = Inspected   NI = Not Inspected   NP = Not Present   D = Deficient

I   NI   NP   D

C. Duct Systems, Chases, and Vents

**Ductwork:** Insulated

**Filter Type:** Disposable

**Filter Size:** N/A

**Comments:**

(1) I recommend changing all HVAC filters upon move in.

(2) Duct piping appears to be in contact with one another in the attic space. Condensation could occur if not corrected. I recommend having a qualified HVAC contractor further evaluate and make repairs as needed.



C. Item 1(Picture) rear

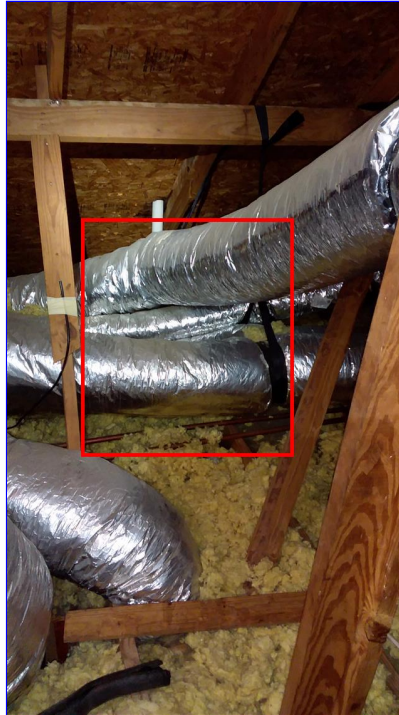

C. Item 2(Picture) rear right

(3) The supply is not sealed in the attic. Energy loss is occurring. I recommend service or repair as needed.

I = Inspected   NI = Not Inspected   NP = Not Present   D = Deficient

I   NI   NP   D



C. Item 3(Picture) rear unit



C. Item 4(Picture) front unit

(4) The supply needs support straps in the attic. Energy loss is occurring. I recommend service or repair as needed.



C. Item 5(Picture) front

The heating and cooling system of this home was inspected and reported on with the above information. While the inspector makes every effort to find all areas of concern, some areas can go unnoticed. The inspection is not meant to be technically exhaustive. The inspection does not involve removal and inspection behind service door or dismantling that would otherwise reveal something only a licensed heat contractor would discover. Please be aware that the inspector has your best interest in mind. Any repair items mentioned in this report should be considered before purchase. It is recommended that qualified contractors be used in your further inspection or repair issues as it relates to the comments in this inspection report.

I = Inspected    NI = Not Inspected    NP = Not Present    D = Deficient

I   NI   NP   D

#### IV. PLUMBING SYSTEM

The home inspector shall observe: Interior water supply and distribution system, including: piping materials, supports, and insulation; fixtures and faucets; functional flow; leaks; and cross connections; Interior drain, waste, and vent system, including: traps; drain, waste, and vent piping; piping supports and pipe insulation; leaks; and functional drainage; Hot water systems including: water heating equipment; normal operating controls; automatic safety controls; and chimneys, flues, and vents; Fuel storage and distribution systems including: interior fuel storage equipment, supply piping, venting, and supports; leaks; and Sump pumps. The home inspector shall describe: Water supply and distribution piping materials; Drain, waste, and vent piping materials; Water heating equipment; and Location of main water supply shutoff device. The home inspector shall operate all plumbing fixtures, including their faucets and all exterior faucets attached to the house, except where the flow end of the faucet is connected to an appliance. The home inspector is not required to: State the effectiveness of anti-siphon devices; Determine whether water supply and waste disposal systems are public or private; Operate automatic safety controls; Operate any valve except water closet flush valves, fixture faucets, and hose faucets; Observe: Water conditioning systems; Fire and lawn sprinkler systems; On-site water supply quantity and quality; On-site waste disposal systems; Foundation irrigation systems; Spas, except as to functional flow and functional drainage; Swimming pools; Solar water heating equipment; or Observe the system for proper sizing, design, or use of proper materials.



I = Inspected    NI = Not Inspected    NP = Not Present    D = Deficient

I   NI   NP   D



water meter front left



water pressure 69 psi



water shut off garafe left



data plate

I = Inspected    NI = Not Inspected    NP = Not Present    D = Deficient

I   NI   NP   D



50 gallon water heater attic

**A. Plumbing Supply Distribution Systems and Fixtures**

**Location of water meter:** Street, Front, Left Side

**Location of main water supply valve:** Front, Left Side

Extra Info: garage

**Static water pressure reading:** 69 psi

**Water Source:** Public

**Plumbing Water Supply (into home):** Copper

**Plumbing Water Distribution (inside home):** Copper

**Water Filters:** None, (We do not inspect filtration systems)

**Comments:**

(1) There is no Anti Siphon device installed on exterior faucet(s). This is not considered to be today's standard. I recommend having a qualified person make repairs as needed.

I = Inspected    NI = Not Inspected    NP = Not Present    D = Deficient

I   NI   NP   D

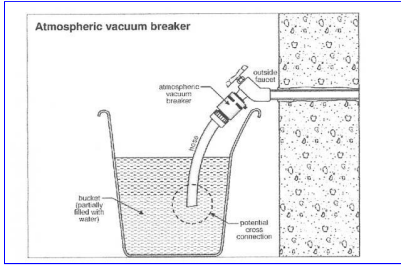

A. Item 1(Picture)



A. Item 2(Picture) left

(2) The outside water faucet leaks when turned on at the exterior areas. Repairs are needed. A qualified person should repair as necessary.

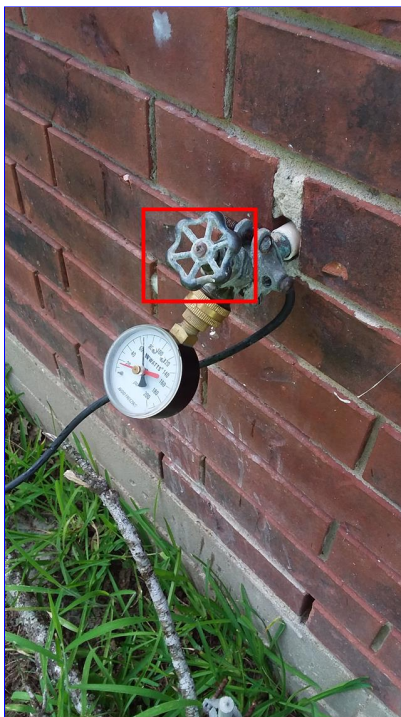

A. Item 3(Picture) left

(3) The hot supply line and cold supply line pressure or volume is fair. A cause for weak or poor pressure



I = Inspected    NI = Not Inspected    NP = Not Present    D = Deficient

I   NI   NP   D

can vary from simple to complex. The repair could also be simple to complex. A qualified licensed plumber should repair or correct as needed.



A. Item 4(Picture) kitchen sink

(4) The control knob is reversed (hot is cold, cold is hot). This is not considered up to today's standard. A qualified licensed plumber should repair or correct as needed.



A. Item 5(Picture) kitchen



I = Inspected   NI = Not Inspected   NP = Not Present   D = Deficient

| I | NI | NP | D |
|---|----|----|---|
|---|----|----|---|

(5) The tub spout diverter is loose at the bath areas. This is not considered up to today's standard. A qualified person should repair as necessary.



A. Item 6(Picture) primary bath

**B. Drains, Waste, and Vents**

**Washer Drain Size:** 2" Diameter

**Plumbing Waste:** PVC

**Comments:**

(1) The bath sink stopper mechanism is not working properly. I recommend repairs as needed.

I = Inspected   NI = Not Inspected   NP = Not Present   D = Deficient

I   NI   NP   D

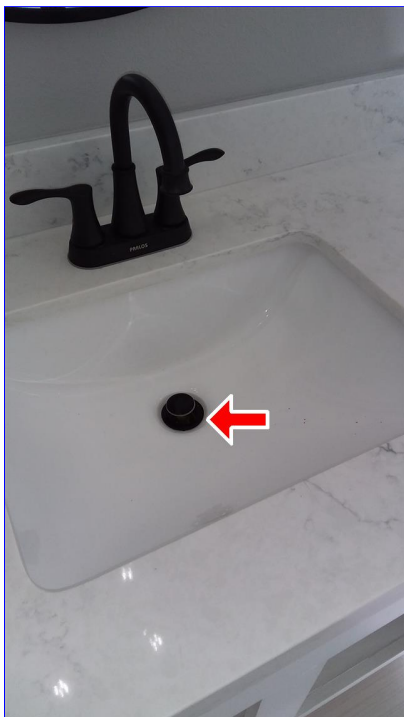

B. Item 1(Picture) hall bath right



B. Item 2(Picture) hall bath



B. Item 3(Picture) half bath

(2) The toilet is loose at tank mount at the bath areas. This is not considered up to today's standard. A qualified person should repair as necessary.

I = Inspected    NI = Not Inspected    NP = Not Present    D = Deficient

I   NI   NP   D



B. Item 4(Picture) half bath



B. Item 5(Picture) primary bath

C. Water Heating Equipment

**Energy Sources:** Gas (quick recovery)

**Capacity (Water Heater):** 50 Gallon (2-3 people)

**Water Heater Manufacturer:** Rheem

**Water Heater Location:** Attic

**Comments:**

(1) The existing piping for T&P valve on water heater fails to extend downward to within six inches of ground. This is a safety issue and should be repaired. A qualified licensed plumber should repair or correct as needed.

I = Inspected    NI = Not Inspected    NP = Not Present    D = Deficient

| I | NI | NP | D |
|---|----|----|---|
|---|----|----|---|



C. Item 1(Picture) right

(2) The gas water heater has improper venting. This is a safety hazard until corrected. I recommend having a qualified plumber evaluate and make repairs as needed.

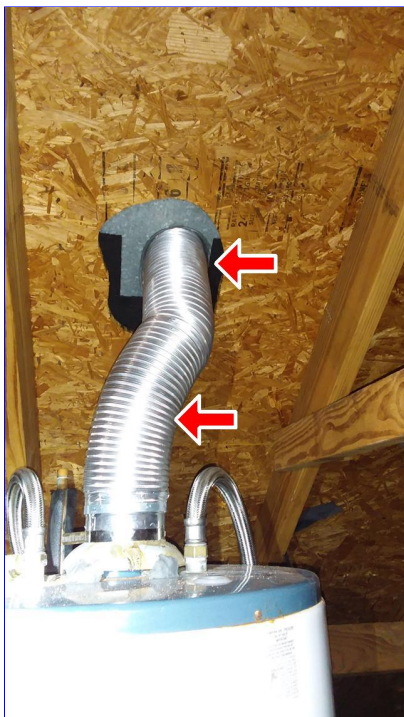

C. Item 2(Picture) incorrect vent pipe



I = Inspected    NI = Not Inspected    NP = Not Present    D = Deficient

I   NI   NP   D

(3) The emergency over flow drain pan for the unit is deteriorated. I recommend replacement.



C. Item 3(Picture)

(4) The water heater is old, rusted and at the end of its life expectancy. No leaks at present. A more thorough inspection by a qualified contractor is needed. A qualified licensed plumber should repair or correct as needed.

I = Inspected    NI = Not Inspected    NP = Not Present    D = Deficient

I   NI   NP   D



C. Item 4(Picture)

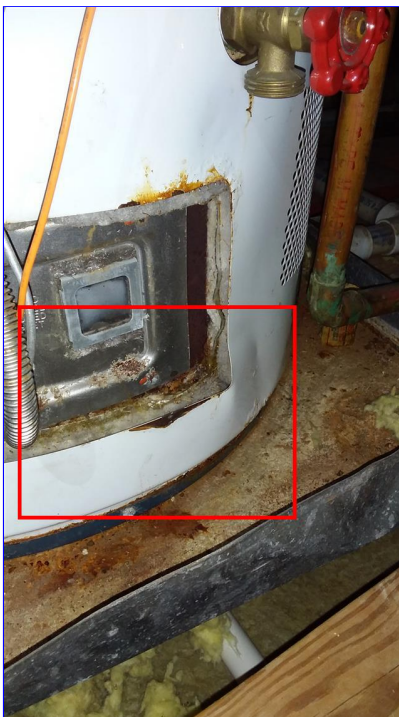

C. Item 5(Picture)

(5) The water heater has corrosion at gas fittings. I recommend having a qualified person make repairs as needed.

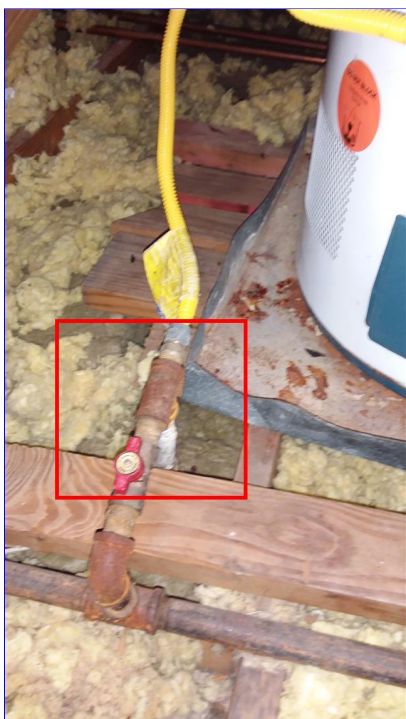

C. Item 6(Picture)

(6) There is an old water heater present in the attic area. I recommend removal by a qualified person.

I = Inspected    NI = Not Inspected    NP = Not Present    D = Deficient

I   NI   NP   D



C. Item 7(Picture) upoer attic

**D. Hydro-Massage Therapy Equipment**

[Comments:](#)

**E. Other**

[Comments:](#)

---

The plumbing in the home was inspected and reported on with the above information. While the inspector makes every effort to find all areas of concern, some areas can go unnoticed. Washing machine drain line for example cannot be checked for leaks or the ability to handle the volume during drain cycle. Older homes with galvanized supply lines or cast iron drain lines can be obstructed and barely working during an inspection but then fails under heavy use. If the water is turned off or not used for periods of time (like a vacant home waiting for closing) rust or deposits within the pipes can further clog the piping system. Please be aware that the inspector has your best interest in mind. Any repair items mentioned in this report should be considered before purchase. It is recommended that qualified contractors be used in your further inspection or repair issues as it relates to the comments in this inspection report.

**I = Inspected    NI = Not Inspected    NP = Not Present    D = Deficient**

**I   NI   NP   D**

## **V. APPLIANCES**

The home inspector shall observe and operate the basic functions of the following kitchen appliances: Permanently installed dishwasher, through its normal cycle; Range, cook top, and permanently installed oven; Trash compactor; Garbage disposal; Ventilation equipment or range hood; and Permanently installed microwave oven. The home inspector is not required to observe: Clocks, timers, self-cleaning oven function, or thermostats for calibration or automatic operation; Non built-in appliances; or Refrigeration units. The home inspector is not required to operate: Appliances in use; or Any appliance that is shut down or otherwise inoperable.



I = Inspected    NI = Not Inspected    NP = Not Present    D = Deficient

I   NI   NP   D



I = Inspected   NI = Not Inspected   NP = Not Present   D = Deficient

I   NI   NP   D



A. Dishwashers

**Dishwasher Brand:** Samsung

**Comments:**

(1) The dishwasher drain hose did not perform a loop to create a trap under sink. I recommend repair as necessary.

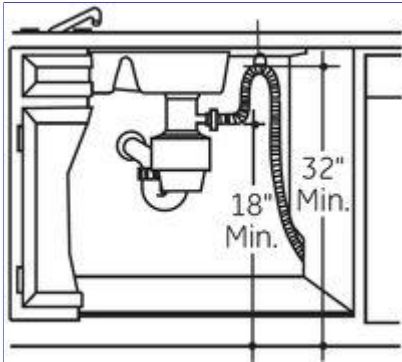

A. Item 1(Picture)

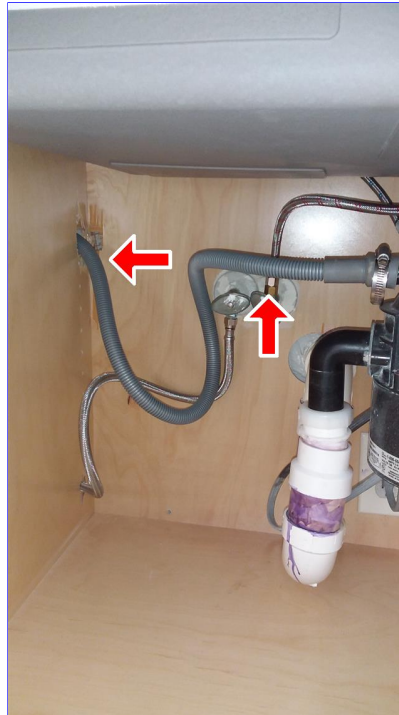

A. Item 2(Picture)

I = Inspected    NI = Not Inspected    NP = Not Present    D = Deficient

I   NI   NP   D

(2) The dishwasher did not operate when tested. I recommend repair as necessary.



A. Item 3(Picture)

**B. Food Waste Disposers**

**Disposer Brand:** Badger

**Comments:**

(1) Tested and working properly at the time of inspection.

(2) The food disposer is rusted inside at the blades and rubber strainer/guard no longer works as intended. I recommend repair as needed.

I = Inspected    NI = Not Inspected    NP = Not Present    D = Deficient

I   NI   NP   D

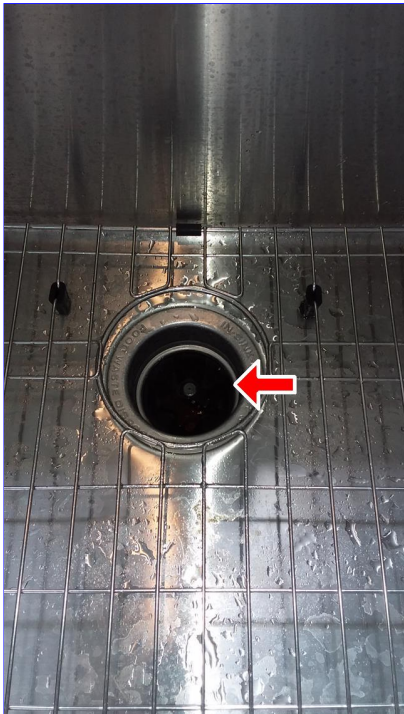

B. Item 1(Picture)

C. Range Hood and Exhaust Systems

**Exhaust/Range hood:** Re-circulate, Samsung

**Comments:**

- (1) Tested and working properly at the time of inspection.
- (2) The kitchen vent hood does not vent to the outdoors. This is not considered to be today's standard.



I = Inspected    NI = Not Inspected    NP = Not Present    D = Deficient

I   NI   NP   D



C. Item 1(Picture)

D. Ranges, Cooktops and Ovens

**Range/Oven:** Samsung

**Comments:**

(1) Tested and working properly at the time of inspection.

I = Inspected    NI = Not Inspected    NP = Not Present    D = Deficient

I   NI   NP   D



D. Item 1(Picture)



D. Item 2(Picture) oven tested at 350°

(2) The stove is installed without the recommended anti-tip device. This is a safety issue. I recommend having a qualified person make repairs as needed.

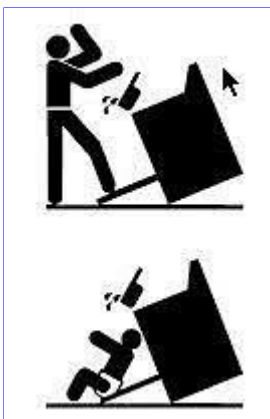

D. Item 3(Picture) anti tip

E. Microwave Ovens

**Built in Microwave:** Samsung

**Comments:**

Tested and working properly at the time of inspection.

I = Inspected    NI = Not Inspected    NP = Not Present    D = Deficient

I   NI   NP   D

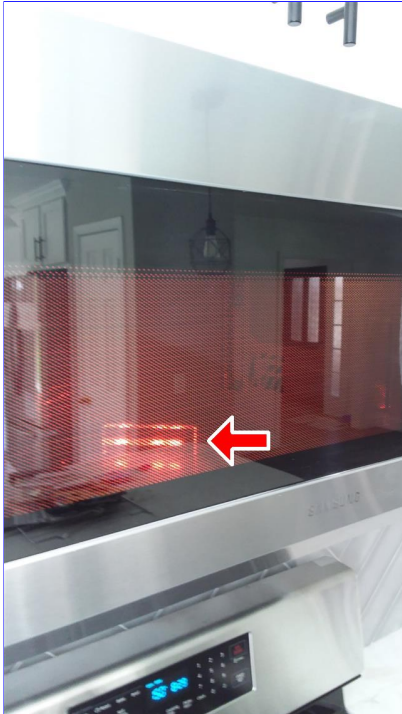

E. Item 1(Picture)

**F. Mechanical Exhaust Vents and Bathroom Heaters**

**Comments:**

- (1) Tested and working properly at the time of inspection.
- (2) The exhaust fan has a damaged vent cover outside. This may allow insects or critters to enter home. A qualified person should repair or replace as needed.

I = Inspected    NI = Not Inspected    NP = Not Present    D = Deficient

I   NI   NP   D



F. Item 1(Picture) left

(3) The exhaust fan is missing at the laundry room. This is for informational purpose to you. A qualified person should repair or replace as needed.

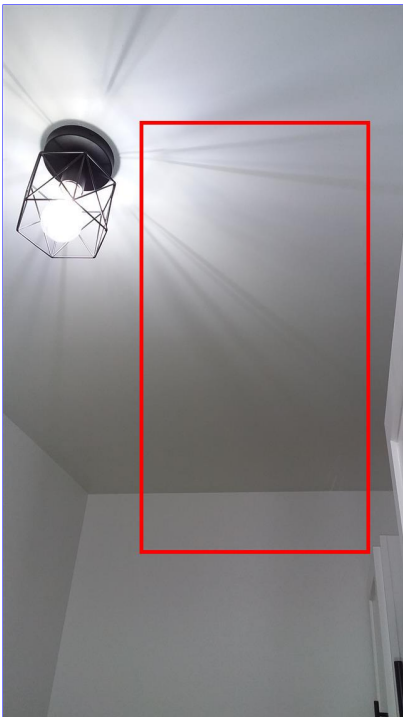

F. Item 2(Picture)

I = Inspected    NI = Not Inspected    NP = Not Present    D = Deficient

| I | NI | NP | D |
|---|----|----|---|
|---|----|----|---|

(4) The exhaust fan is noisy at the bath areas. This is for informational purpose to you. A qualified person should repair or replace as needed.



F. Item 3(Picture) primary bath

G. Garage Door Operator(s)

[Comments:](#)

(1) The garage door opener is in place but is not operational.



I = Inspected    NI = Not Inspected    NP = Not Present    D = Deficient

I   NI   NP   D

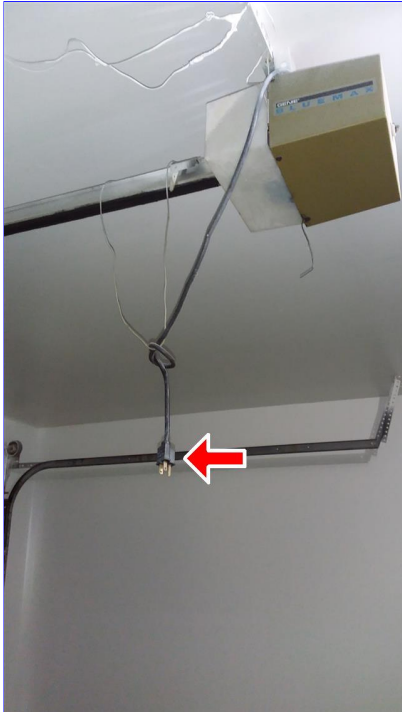

G. Item 1(Picture) unplugged

(2) The automatic opener for garage door at the front of home has electronic sensors located higher than six inches off floor which may not be installed according to manufacturers specification. This is considered unsafe and needs correcting. A qualified person should repair or replace as needed.



G. Item 2(Picture) both sensors

I = Inspected    NI = Not Inspected    NP = Not Present    D = Deficient

| I | NI | NP | D |
|---|----|----|---|
|---|----|----|---|

**H. Dryer Exhaust Systems**

[Comments:](#)

The dryer vent piping is long and vertical which can trap lint at elbow. Vent pipes should be cleaned regularly if they are longer than normal ( 10 feet or more) or vented vertically. I recommend repair as needed.

**I. Other**

[Comments:](#)

---

The built-in appliances of the home were inspected and reported on with the above information. While the inspector makes every effort to find all areas of concern, some areas can go unnoticed. Please be aware that the inspector has your best interest in mind. Any repair items mentioned in this report should be considered before purchase. It is recommended that qualified contractors be used in your further inspection or repair issues as it relates to the comments in this inspection report.

I = Inspected    NI = Not Inspected    NP = Not Present    D = Deficient

I   NI   NP   D

## VI. OPTIONAL SYSTEMS



in ground pool rear



pool pumps rear left

A. Landscape Irrigation (Sprinkler) Systems

Comments:

B. Swimming Pools, Spas, Hot Tubs, and Equipment

**Type of Construction:** Gunite (concrete)

**Style:** In ground

**Shape:** Freeform

Comments:

(1) Any area with a pool or spa should be equipped with safety features: Fencing (minimum 4ft), Self closing/latching/lockable gates (latch 54 inches), Door alarms on any doors leading to pool area and Splash alarms. I recommend consulting your insurance provider and their recommendation and requirements.

(2) Our company does not inspect pool for leaks or seepage. Only components readily accessible are inspected.

(3) Concrete walls and Pool floor bottom is discolored. A qualified pool professional should evaluate and repair as needed..

I = Inspected   NI = Not Inspected   NP = Not Present   D = Deficient

| I | NI | NP | D |
|---|----|----|---|
|---|----|----|---|

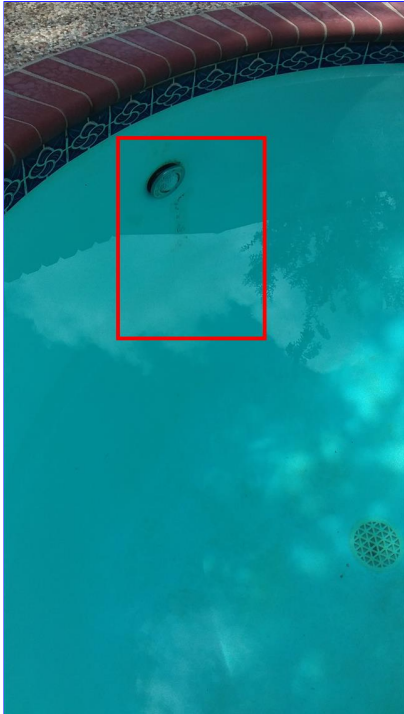

B. Item 1(Picture)



B. Item 2(Picture)



B. Item 3(Picture)

(4) Tile wall is loose or deteriorated. I recommend repair by a qualified person.

I = Inspected   NI = Not Inspected   NP = Not Present   D = Deficient

I   NI   NP   D



B. Item 4(Picture)



B. Item 5(Picture)

(5) Pool equipment has valves that not clearly marked and the equipment does not appear to be properly bonded. I recommend having a pool professional evaluate, mark and repair as needed.



I = Inspected   NI = Not Inspected   NP = Not Present   D = Deficient

I   NI   NP   D

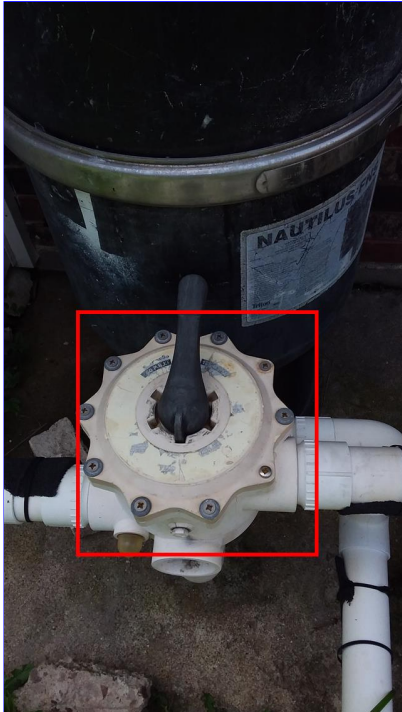

B. Item 6(Picture) not labeled



B. Item 7(Picture) not grounded properly



B. Item 8(Picture) equipment rusting



B. Item 9(Picture) pipes repaired inproperly

C. Outbuildings

Comments:

I = Inspected    NI = Not Inspected    NP = Not Present    D = Deficient

| I | NI | NP | D |
|---|----|----|---|
|---|----|----|---|

**D. Private Water Wells (A coliform analysis is recommended)**

[Comments:](#)

**E. Private Sewage Disposal (Septic) System**

[Comments:](#)

**F. Other**

[Comments:](#)

**G. Outdoor Cooking Equipment**

[Comments:](#)