

CITY OF GALVESTON

DESIGN STANDARDS for HISTORIC PROPERTIES



APRIL 30, 2012 

PROGRESS GALVESTON

Prepared by Winter & Company and HDR Engineering for the City of Galveston, Texas as part of Progress Galveston, a planning initiative led by the City's Department of Planning & Community Development. Technical assistance provided by Kendig Keast Collaborative and the Law Offices of Kimberley Mickelson.

City of Galveston Landmark Commission

Richard Batie (former Commissioner)
Michael Culpepper
Greg Lewis
Heidi Lutz
Russell Mertens (Alternate)
Charlotte O'Rourke
Joe Rozier
Tom Schwenk (Alternate)
Nelson Smelker
Linda Strevell
Rusty Legg (Ex-Officio)

City of Galveston Department of Planning and Community Development

Wendy O'Donohoe, Director
Lori Feild Schwarz, AICP, Assistant Director of Planning and Special Projects/HPO
Catherine Gorman, AICP, Planning Manager/Assistant HPO

Winter & Company

Noré Winter
Abe Barge, AICP

HDR Engineering, Inc.

Steve Schukraft, AICP
Stefanie McQueen, AICP

Completed as part of Progress Galveston, a planning initiative led by the City's Department of Planning & Community Development with technical assistance provided by HDR Engineering, Inc., Kendig Keast Collaborative and the Law Offices of Kimberley Mickelson.

Partial funding provided through a grant from the U.S. Department of Housing and Urban Development.



Contact:
City of Galveston
Department of Planning & Community Development
823 Rosenberg | P.O. Box 779
City of Galveston, TX 77553
(409) 797-3660
progressgalveston@cityofgalveston.org
www.ProgressGalveston.com



Special thanks to David Salyer for the loan of his private collection of Galveston postcards.

CONTENTS

Introduction	1
Design Standards Users	2
Property Owners.....	2
The Landmark Commission.....	3
City Staff.....	3
Other Design Standards Users.....	3
Policy Base for the Standards	4
Galveston Comprehensive Plan.....	4
Galveston Historic Preservation Plan.....	4
Regulatory Framework	5
Zoning Code.....	5
Historic Preservation Ordinance.....	6
Where the Design Standards Apply	7
Locally-Designated Individual Historic Landmarks.....	7
Locally-Designated Historic Districts.....	8
Chapter 1	
Using the Design Standards	11
The Design Review System	12
Application Process.....	14
Administrative Approval.....	16
Appeals.....	16
Other Permits or Applications Reviewed by the Landmark Commission.....	16
Exemptions and Benefits	18
Design Standards Organization	20
Design Standards Components	21





Chapter 2
Design Standards for All Historic Preservation Projects **23**

General Preservation Principles 24

Standards for the Treatment of Historic Features 30

Materials and Finishes..... 30

Building Elements 37

Architectural Details..... 45

Additional Standards for Historic Buildings..... 47

Storm-Safety Features on Historic Buildings 47

Adaptive Reuse 49

Historic Additions 50

Accessibility 50

Utility Equipment..... 52

Sustainability Standards for Historic Properties 53

Planning a Rehabilitation Project for Energy Efficiency 53

Maintaining the Inherent Energy Efficiency of a Historic Building 58

Enhancing Energy Performance of Historic Structures..... 59

Using Energy-Generating Technologies 61

Chapter 3
Design Standards for Residential Properties **67**

Residential Development Patterns 68

Design Standards for All Residential Properties 71

Residential Site Standards 71

Residential Building Standards 76

Standards for Elevated Residential Foundations..... 80

Standards for Residential to Commercial Conversion..... 84

Design Standards for Residential New Construction and Additions 85

Site Standards for New Residential Construction 86

Massing Standards for New Residential Construction 88

Building Standards for New Residential Construction 92

Standards for New Secondary Buildings on Residential Properties 95

Standards for Residential Additions..... 96

Chapter 4

Design Standards for Commercial Properties 99

Commercial Development Patterns 100

Design Standards for All Commercial Properties 101

Commercial Site Standards 101

Commercial Building Standards 109

Commercial Signage Standards 115

Design Standards for New Commercial Construction and Additions 121

Massing Standards for New Commercial Construction 121

Building Standards for New Commercial Construction 124

Standards for New Commercial Structures in Residential Districts 129

Standards for New Parking Structures 131

Standards for Commercial Additions 132

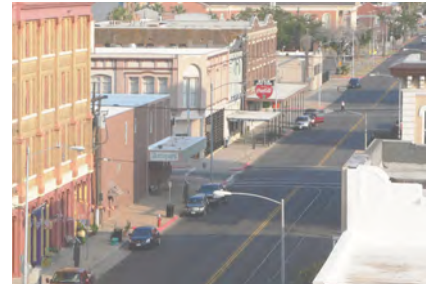

Chapter 5

Local Historic Districts 135

East End Historic District 137

Design Traditions 137

Concerns and Objectives 139

Lost Bayou Historic District 141

Design Traditions 141

Concerns and Objectives 141

Silk Stocking Historic District 143

Design Traditions 143

Concerns and Objectives 143

Strand/Mechanic Historic District 145

Design Traditions 146

Concerns and Objectives 146

Additional Context-Specific Design Standards for the Strand/Mechanic Historic District 147





Appendices

A-1

Appendix I. Historic Architectural Styles and Types	A-2
Alley House	A-2
Art Deco	A-2
Colonial Revival	A-3
Commissary House/Shotgun Cottage	A-3
Gable Front Cottage	A-4
Double Gallery House	A-5
Exotic Revival	A-5
Gable-End Dormered Cottage	A-5
Galveston Vernacular Buildings	A-6
Greek Revival	A-6
Italianate	A-6
Mission	A-7
Moderne	A-7
Neoclassical/Classical Revival	A-7
Prairie	A-8
Ranch/Modernist	A-8
Queen Anne	A-9
Second Empire	A-9
Spanish Eclectic	A-10
Tudor	A-10
Appendix II. Glossary of Terms	A-11
Secretary of the Interior’s Standards for the Rehabilitation of Historic Properties	A-21
Appendix III. Background Resources	A-21
Preservation Resources in Galveston	A-22
State Preservation Resources	A-23
National Preservation Resources	A-23
Preservation-Related Publications	A-23
Appendix IV. Designation and Application Process	A-25
Process for Individual Landmark Designation	A-25
Permitting and Appeals Process	A-26
How to Present to the Landmark Commission	A-27
Appendix V. Approved Paint Palettes	A-28
Appendix VI. Amendments	A-29

INTRODUCTION

Galveston is nationally recognized for its historic resources. They are enjoyed by residents, business owners and visitors as links to the City’s heritage while also setting the stage for a vibrant future. Preserving these assets is essential to Galveston’s well being. The *Design Standards for Historic Properties* promote the community’s vision for sustainable preservation by guiding appropriate stewardship of historic resources and compatible redevelopment in locally-designated historic districts.

The *Design Standards* guide rehabilitation, alteration, expansion and new construction projects involving locally-designated individual historic landmarks and properties in locally-designated historic districts. They also guide Landmark Commission review of such projects, helping the City and property owners maintain the special qualities of Galveston’s historic resources.

By preserving existing buildings and guiding compatible redevelopment, the *Design Standards* promote the three key elements of community sustainability:

- **Economic Sustainability.** The economic benefits of protecting historic resources include higher property values, job creation in rehabilitation industries and increased heritage tourism.
- **Environmental Sustainability.** Rehabilitation of historic resources directly supports environmental sustainability through conservation of embodied energy, adaptability, and maintenance of sustainable development patterns.
- **Cultural/Social Sustainability.** Preserving historic places and patterns promotes cultural and social sustainability by supporting everyday connections between residents and the cultural heritage of the community.



In This Chapter	
Design Standards Users	2
Property Owners	2
The Landmark Commission	3
City Staff	3
Other Design Standards Users	3
Policy Base for the Standards	4
Galveston Comprehensive Plan	4
Galveston Historic Preservation Plan	4
Regulatory Framework	5
Zoning Code	5
Historic Preservation Ordinance	6
Where the Design Standards Apply	7
Locally-Designated Individual Historic Landmarks	7
Locally-Designated Historic Districts	8

What is Historic Preservation?



Preservation means having properties and places of historic and cultural value in active use and accommodating appropriate improvements to sustain their viability while maintaining the key, character-defining features which contribute to their significance as cultural resources. Preservation also means keeping cultural resources intact for the benefit of future generations.

Historic preservation is also an integral component of other community initiatives in neighborhood livability, sustainability, economic development and culture. With this understanding, the term “historic preservation” includes the specific methodologies associated with maintaining the integrity of significant resources, but also covers a range of “character management tools” that serve to maintain traditional features of established neighborhoods. Many of these tools are described in the separate *Galveston Preservation Plan* document.

DESIGN STANDARDS USERS

The *Design Standards* are used primarily by property owners, design professionals, City staff, and the Landmark Commission. While they are written for use by the lay-person to plan improvements, property owners are strongly encouraged to enlist the assistance of qualified design and planning professionals, including architects and preservation consultants. See Chapter 1 for more information.

Property Owners

Property owners should consult this document to help determine what types of alterations, restorations, rehabilitations and other changes are appropriate to maintain the integrity of locally-designated individual historic landmarks and properties in locally-designated historic districts.

Note that the *Design Standards* apply only to the exterior of properties. For example, the Landmark Commission reviews applications for new fences porches and steps, shutter installations, additions, new construction and exterior renovation or rehabilitation. The Commission does not review interior remodeling. See “Application Process” on page 14 for more information.

Property Owner’s Responsibilities and Benefits

Ownership of locally-designated individual historic landmarks and properties in locally-designated historic districts comes with responsibilities and benefits.

Owners have the right to the use and enjoyment of their property and may make interior modifications to their properties without special review. However, they must also maintain the historic integrity of their property and the character of the City’s historic districts. At the same time, owners also benefit from historic designation through increased property values and specific incentive and benefit programs.

Owners of historic properties may make exterior alterations and undertake new construction that meets the *Design Standards* and follows the application and permit process described in “Application Process” on page 14. They may also appeal City staff or Landmark Commission decisions as described on page 16.

Studies in Texas and around the nation have demonstrated that historic district protections help stabilize, and even enhance, property values. Additional benefits available to owners of historic properties, such as tax credits and building code exemptions, are described on page 18.

The Landmark Commission

The Landmark Commission is a citizen board charged with using the *Design Standards for Historic Properties* to review and regulate the rehabilitation, restoration, expansion, alteration or demolition of locally-designated individual historic landmarks and contributing properties in locally-designated historic districts. The Commission also reviews and regulates new construction in local historic districts. When the Commission has reviewed and approved a project using the process outlined in “Application Process” on page 14, they issue a Certificate of Appropriateness (COA).

City Staff

City staff assist the Commission with administration of the *Design Standards*. Staff provide recommendations to the Commission regarding approval of projects and may administratively approve some projects as noted in the relevant *Design Standards*.

City staff are led by the Historic Preservation Officer (HPO), a Department of Planning and Community Development position created in 2001. Currently, the Historic Preservation Officer is also the head of the Planning Division.

Other Design Standards Users

The overall community and businesses or residents seeking to acquire or use historic resources may also use the *Design Standards* to better understand appropriate rehabilitation strategies and the City’s expectations for treatment of its historic resources.



What is a Design Standard?

Design standards provide a qualitative framework for making consistent decisions about the appropriate design of sites and buildings. In addition, they serve as educational and planning tools for property owners and their design professionals who seek to make improvements. Such standards are also often referred to as “design guidelines” because they guide a review process that determines the appropriateness of specific designs. Design standards are more flexible than zoning regulations, and require interpretation by a qualified review board or City staff.

The Landmark Commission conducts design review using the *Design Standards for Historic Properties*. As described in “Administrative Approval” on page 16, the Commission has delegated review authority for some types of projects to the City’s HPO or other designated City staff.

See “Zoning Regulations vs. Design Standards” on page 5 for more information on the relationship between zoning regulations and design standards.

Landmark Commission Membership

Commission members are appointed by the City Council to staggered three-year terms (or one year for the ex-officio member). The Commission includes owners of properties in historic districts, a design professional, a city resident-at-large, a member of the Planning Commission and a City Council member. The Council member does not vote on Landmark Commission business.

POLICY BASE FOR THE STANDARDS

The *Design Standards* reflect the City’s goal to enhance its image while promoting sustainability and economic development. The policy base for the *Design Standards* exists in several key policy documents including the *Galveston Comprehensive Plan* and *Historic Preservation Plan*.

The Secretary of the Interior’s Standards for Historic Properties



The Secretary of the Interior has published Standards and Guidelines for the Treatment of Historic Properties, which serve as a model nationwide.

They are organized into four approaches:

- Preservation,
- Rehabilitation,
- Restoration
- Reconstruction

Of these, the Rehabilitation treatment provides the broadest and most flexible approach and serves as the basis for Galveston’s Design Standards. The Secretary of the Interior’s Standards are included in the Appendix and are also available online at:

<http://www.nps.gov/hps/tps/standguide/>

Galveston Comprehensive Plan

The City of Galveston adopted an updated Comprehensive Plan in 2011. The Historic Preservation Element of the plan notes the importance of the City’s lead role in the preservation of historic resources and promotes key policies including:

- Development of a Historic Preservation Plan
- Development of specific neighborhood plans
- Revision of the Design Guidelines for Historic Districts
- Maintenance of historic buildings owned by the City
- City-wide survey of historic properties
- Additional local historic district designations
- Further code enforcement within historic areas
- Development of conservation districts
- Down-zoning historic areas for more appropriate land uses
- Tax incentives for residential properties
- Partnerships with other local preservation organizations

Galveston Historic Preservation Plan

In 2011, the City of Galveston developed an update to the 2005 *Progress Through Preservation Plan*. The Plan describes a vision for preservation in the community and provides goals, objectives and specific actions for administration of the preservation program, identification and management of historic resources, education and advocacy. The Preservation Plan is a guiding document for the City of Galveston in planning for the future of the island while maintaining its historic resources.

REGULATORY FRAMEWORK

The *Design Standards* are part of a framework of regulatory tools that shapes development in Galveston. The tools include zoning standards that relate to all properties in the city and a historic preservation ordinance that outlines specific regulations that apply to locally-designated individual historic landmarks and properties in locally-designated historic districts.

Zoning Code

The zoning code sets forth the basic rules that shape development throughout the city. The zoning code includes a special overlay that enables Commission review of improvement projects in local historic districts.

Zoning Regulations vs. Design Standards

The distinction between zoning regulations and design standards is briefly summarized below.

Zoning Regulations

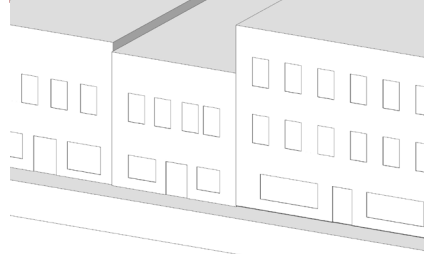

- Zoning standards address:*
- Density
 - Use
 - Building placement
 - Lot coverage by buildings
 - Height

Design Standards



- Design Standards address:*
- Compatibility
 - Site design
 - Building scale, orientation and massing
 - Historic rehabilitation
 - Entries and windows

*A partial list of requirements and design considerations addressed by zoning regulations and design standards in Galveston.

Neighborhood Conservation Districts



The Neighborhood Conservation District (NCD) is a zoning tool used to maintain neighborhood character, retain affordable housing, and protect an area from inappropriate development. Such districts can serve as catalysts for rehabilitation of existing buildings.

Neighborhoods that do not wish to be or may not qualify for historic district status may opt to be a neighborhood conservation district.

The *Design Standards for Historic Properties* do not apply in Neighborhood Conservation Districts. However, property owners may wish to consult the standards voluntarily to assist with planning compatible improvement projects.

Certified Local Government



The City of Galveston became a Certified Local Government (CLG) in 2001. This program is a local, state and federal government partnership for historic preservation. The Texas Historical Commission administers the program at the state level and the National Park Service is the responsible federal agency.

In Texas, a city or a county may apply to become a Certified Local Government (CLG). To qualify as a CLG, a local government must:

1. Enforce state or local legislation that protects historic properties
2. Establish a qualified review commission composed of professional and lay members
3. Maintain a system for surveying and inventorying historic properties
4. Provide for public participation in the historic preservation process, including recommending properties to the National Register of Historic Places.

Historic Preservation Ordinance

The Preservation Ordinance is designed to achieve the following goals:

1. To conserve, preserve, protect, enhance and perpetuate historically, culturally, and architecturally significant sites, structures and landmarks which serve as visible reminders of the City's culture and heritage.
2. To promote the economic prosperity and welfare of the community by conserving the value of landmark buildings and encouraging the most appropriate use of such property within the city.
3. To foster and strengthen civic pride through neighborhood conservation.
4. To provide a review process for the appropriate preservation and development of important cultural, architectural and historic resources.
5. To ensure harmonious, orderly, safe and efficient growth and development of the City, without compromising its historical and architectural integrity.
6. The resource identification, designation and review procedures established in the ordinance are regulatory tools that allow the City to maintain Certified Local Government status as described at left.



WHERE THE DESIGN STANDARDS APPLY

The *Design Standards* apply to the exterior of Galveston Landmarks, including locally-designated individual historic landmarks and properties in locally-designated historic districts. The standards also apply to new construction and additions in locally-designated historic districts. The *Design Standards* do not apply in Neighborhood Conservation Districts.

Locally-Designated Individual Historic Landmarks

A number of buildings in Galveston have been designated as local historic landmarks. Most such buildings, such as Ashton Villa, and the Samuel May Williams House, are not in locally-designated historic districts. They are, however, subject to the same regulations, including the *Design Standards*. Owners of locally-designated historic landmarks may be eligible for special benefits as described in “Exemptions and Benefits” on page 18.

Locally-designated historic landmarks may also be a designated Texas Landmark and/or may be listed on the National Register of Historic Places. However, not all Texas Landmarks or National Register-listed buildings are locally-designated as individual landmarks.



The house at 1207 Post Office St. became Galveston’s newest locally-designated individual historic landmark in 2011.



The locally-designated Strand Mechanic Historic District was Galveston’s primary commercial center from the 1850s to the early 1900s.

Galveston Landmarks



Galveston Landmarks include individual buildings, structures or objects that have been locally-designated by the Galveston Landmark Commission or are sited in a locally-designated historic district.

Projects involving Galveston Landmarks are subject to review by the Landmark Commission using the *Design Standards*. Applications for Landmark designation are available online at:

www.cityofgalveston.org/online_services/forms/forms_online.cfm

Texas Historic Landmarks



A number of buildings in Galveston are designated by the state as Texas Historic Landmarks, such as Ashton Villa. While special incentives and benefits may be available to Texas Landmarks, it is important to note that they are not subject to review using the *Design Standards*, unless they are also locally-designated historic landmarks or are located in locally-designated historic districts.

The National Register of Historic Places



Galveston includes a number of landmarks and districts that are listed on the National Register of Historic Places, such as the Cedar Lawn National Register Historic District. While special incentives and benefits may be available to National Register properties, it is important to note that they are not subject to review using the *Design Standards*, unless they are also locally-designated historic landmarks or are located in locally-designated historic districts.

Locally-Designated Historic Districts

Galveston has four locally-designated historic districts. The *Design Standards* apply to properties in each of these districts. Owners of properties in locally-designated historic districts may be eligible for special benefits as described in “Exemptions and Benefits” on page 18.

Locally-designated historic districts may also be National Register Historic Districts. However, not all National Register districts are also locally-designated historic districts.

Galveston’s four locally-designated historic district are briefly summarized below. Additional information and context-specific *Design Standards* for each district are provided in Chapters 5 through 8.

EAST END HISTORIC DISTRICT

Galveston’s first locally-designated historic district originally consisted of about 40 blocks of the city’s original residential area, directly to the east of downtown. The district was expanded to the east in 1994. It is both a locally-designated historic district and a National Register Historic Landmark District.

LOST BAYOU HISTORIC DISTRICT

Galveston’s most recently-established local historic district was designated in 1994. It is comprised of approximately 23 blocks south of Broadway Boulevard between 21st Street and 16th Street. The neighborhood was extensively damaged by the 1900 storm. As a result, it includes many early 20th Century buildings.

SILK STOCKING HISTORIC DISTRICT

The district was designated in 1975, with 25th Street, as the core thoroughfare. The neighborhood is one of the most intact residential areas in the city from the late 19th and early 20th century. It is both a locally-designated historic district and a National Register Historic District.

STRAND/MECHANIC HISTORIC DISTRICT

Galveston’s only local historic commercial district was designated in 1988 and includes about 13 blocks of the city’s historic commercial center. The Strand Mechanic area was Galveston’s primary commercial district from the 1850s to the early 1900s and was often referred to as “the Wall Street of the Southwest”. It is both a locally-designated historic district and a National Register Historic Landmark District.

Map A.1: Locally-Designated Historic Districts





Tremont Street in Downtown Galveston

CHAPTER 1

USING THE DESIGN STANDARDS

Galveston’s older neighborhoods are unique and valued for their historic resources. The *Design Standards for Historic Properties* are a tool to guide improvements to locally-designated individual historic landmarks and properties in locally-designated historic districts. They inform a design review process that helps ensure that changes to the built environment will be sensitive to the community’s historical legacy.

This chapter provides a guide to using the *Design Standards*. It describes the overall design review process of which the *Design Standards* are part, including application processes for property owners planning improvements and the role of the Galveston Landmark Commission. It also describes which *Design Standards* are relevant to specific types of projects, and explains the format and use of a design standard.

The Landmark Commission and owners of historic properties should use this chapter to determine application requirements for proposed improvements, as well as the specific *Design Standards* chapters that will inform the design review process. Owners of historic properties may also use this chapter to review specific exemptions, benefits and incentives that may be available to help balance property-owner responsibilities and promote preservation objectives in Galveston.



In This Chapter

The Design Review System	12
Application Process	14
Administrative Approval	16
Appeals	16
Other Permits or Applications Reviewed by the Landmark Commission.....	16
Exemptions and Benefits	18
Design Standards Organization	20
Design Standards Components	21

THE DESIGN REVIEW SYSTEM

The *Design Standards* provide the principal framework for a historic design review process that applies to locally-designated historic resources. This document is organized into chapters that can be grouped into “design review tracks”

Chart 1.1: Design Review Tracks

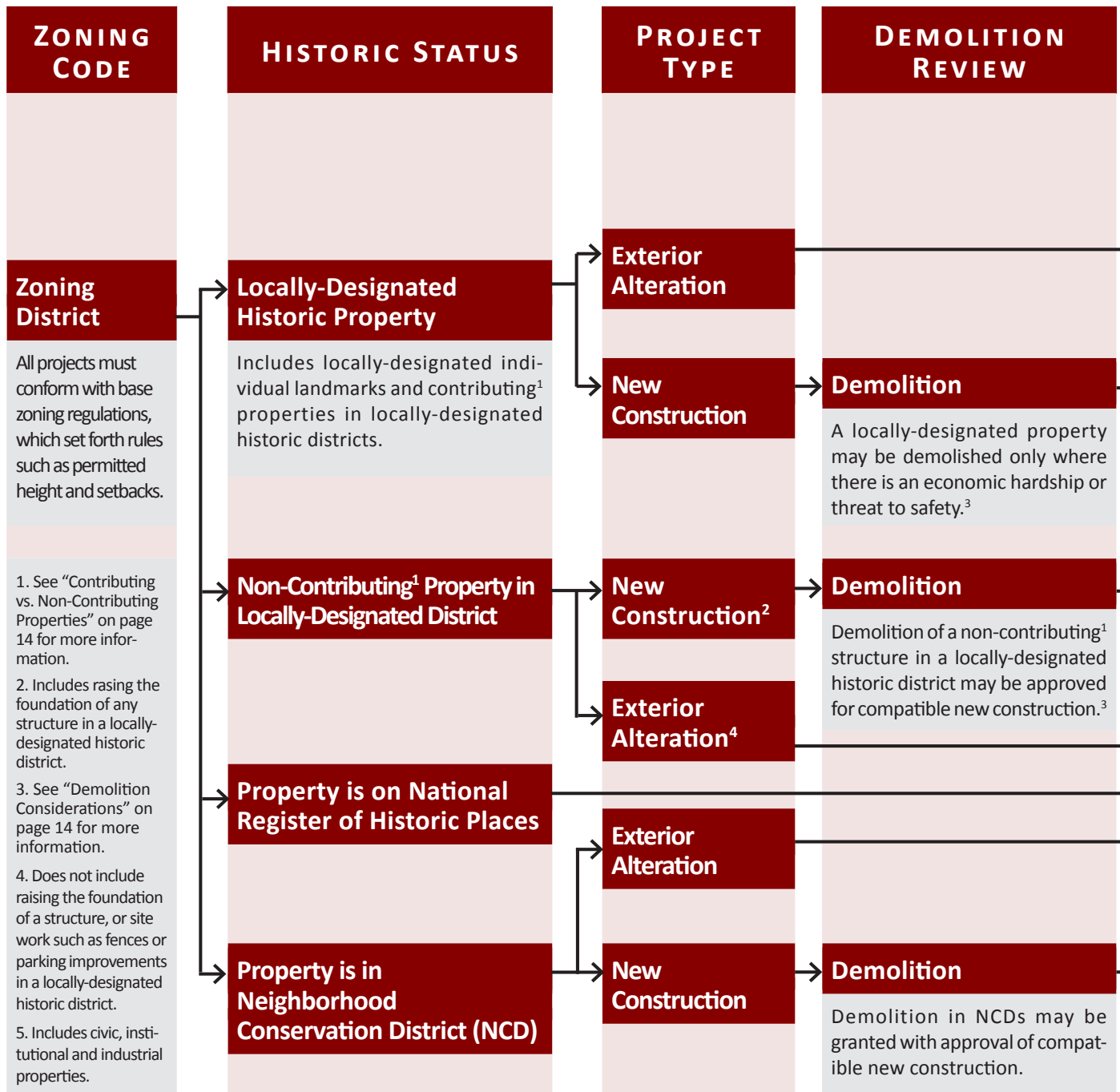

for different types of properties and improvement projects as summarized in the chart below. The final column in the chart indicates which chapters apply to different types of properties and projects. Note that the chart also indicates property and improvement types where the design review process using the *Design Standards* does not apply, such as for improvements to properties on the National Register of Historic Places or properties in neighborhood conservation districts.

PROPERTY TYPE	DESIGN REVIEW TRACK
Residential	Track 1: Alteration of a Historic Residential Building Refer to Chapters 1, 2, 3 and 5 of the <i>Design Standards</i> .
Commercial ⁵	Track 2: Alteration of a Historic Commercial Building. Refer to Chapters 1, 2, 4 and 5 of the <i>Design Standards</i> .
Residential	Track 3: New Residential Construction Refer to Chapters 1, 3 and 5 of the <i>Design Standards</i> . The new construction section beginning on page 85 of Chapter 3 is especially important.
Commercial ⁵	Track 4: New Commercial Construction Refer to Chapters 1, 4 and 5 of the <i>Design Standards</i> . The new construction section beginning on page 121 of Chapter 4 is especially important, as are the additional guidelines beginning on page 147 of Chapter 5 if the project is in the Strand/Mechanic Historic District.
	Track 5: No Historic or Conservation District Review The <i>Design Standards</i> do not apply to properties in NCDs, properties on the National Register (that are not also locally-designated), or alterations to most non-contributing properties in locally-designated historic districts. ⁴ Minor alterations in NCDs are generally not subject to special regulations.
	Track 6: Separate Neighborhood Conservation District Regulations The <i>Design Standards for Historic Properties</i> do not apply. Properties in NCDs are not subject to design review. Refer to separate conservation district regulations for guidance on demolition and new construction in an NCD.

Application Information



Applications for approval of improvements to locally-designated individual historic landmarks and properties in locally-designated historic districts are available from the Planning Division or online at:

www.cityofgalveston.org/online_services/forms/forms_online.cfm

Applications to the Commission must be submitted to the Planning Division by the deadline date (typically 28 days prior to the scheduled hearing). All required supporting materials must accompany the application.

The Landmark Commission conducts a public hearing once or twice a month, typically on the first and third Mondays. Public hearing dates and application deadlines are available from the Planning Division at 409-797-3660.

Applicants should attend the scheduled hearing and be prepared to answer questions from the Landmark Commission.

The City's Historic Preservation Officer (HPO) or designated Planning Division staff are available to meet with property owners to help determine application requirements.

Application Process

The Landmark Commission (or City staff where administrative approval is allowed as described on page 14) must issue a Certificate of Appropriateness (COA) for the following types of improvements to locally-designated individual historic landmarks and properties in locally-designated historic districts prior to application for a building permit:

- Exterior construction
- Reconstruction, rehabilitation or restoration of local landmarks and contributing structures in local historic districts
- Relocation of a structure
- Demolition of a structure

The chart on page 15 illustrates the steps that a property owner should follow when planning an improvement project. See "Permitting and Appeals Process" on page A-26 of the appendix for additional detail.

Contributing vs. Non-Contributing Properties

Within locally-designated historic districts, some structures are considered to be "contributing" to the historic significance of the district. Other structures may be considered to be "non-contributing" because they do not specifically contribute to the historic significance of the district. The contributing or non-contributing status of properties is often established in historic surveys. In some cases, however, it may be necessary for City staff or the Landmark Commission to determine contributing status during the design review process using their adopted criteria.

In many cases, the *Design Standards* distinguish between contributing and non-contributing properties. For example, special standards apply to additions to contributing structures that do not apply to additions to non-contributing structures.

Demolition Considerations

The preservation of Galveston's historic resources helps maintain the community's unique identity and quality of life. Demolition of any primary or secondary structure, or any portion of the exterior of a structure that is a locally-designated historic landmark or is considered to be a contributing structure in a locally-designated historic district will generally not be permitted. However, The Landmark Commission will consider requests for removal of inappropriate additions and alterations that are not original.

Galveston's zoning standards include the specific requirements for demolition applications, including the criteria for claims of economic hardship or unusual and compelling circumstances, and evaluation of threats to safety. Demolition requests must include a presentation of any new construction, additions or improvements proposed after the demolition. The Commission will review such plans using the *Design Standards*. It is the burden of the applicant to prove the necessity for demolition.

Chart 1.2: Application Process

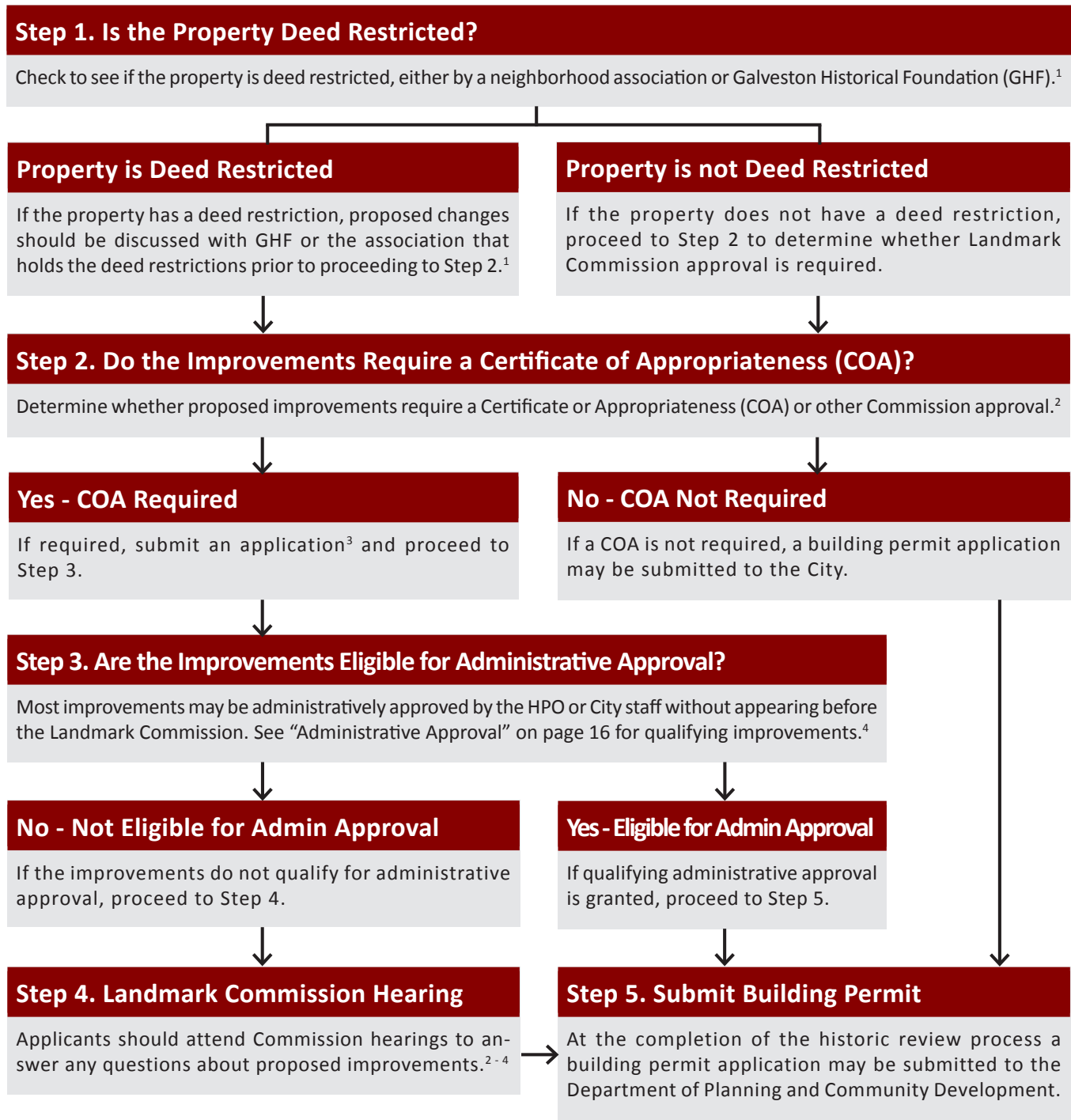

¹Note that the City of Galveston does not enforce deed restrictions

²The City’s HPO is available to assist property owners as described in “Application Information” on page 14.

³See “Application Information” on page 14 for information on Commission meeting dates and application deadlines.

⁴See “Appeals” on page 16 for more information on appealing decisions by City staff or the Landmark Commission.

Interpreting the Design Standards

IMPORTANT

The Landmark Commission and City staff shall take these factors into consideration when reviewing proposed work on a historic resource:

- The significance of the property
- Its context, with respect to other historic properties
- The location of any key, character-defining features
- The condition of those features

In addition, there are many cases in which the standards state that one particular solution, is preferred, such as for the replacement of a damaged or missing feature, but the standard further notes that some alternatives may be considered if the preferred approach is not feasible. In determining such feasibility, the city will also consider:

- The reasonable availability of the preferred material
- The skill required to execute the preferred approach
- The quality, appearance and character of solutions, such as alternative materials.

Some design standards note that an alternative may be considered by the Landmark Commission on a “case by case basis.” This does not mean that the City may choose to waive the standard, but simply that its interpretation in a particular application may require closer consideration of the same factors that are described above.

Administrative Approval

Most exterior improvements to locally-designated individual historic landmarks and properties in locally-designated historic districts may be administratively approved by the Historic Preservation Officer (HPO) or designated City staff without formal review by the Landmark Commission. “Chart 1.3: Guide for Administrative Approval” on page 17 indicates the specific types of projects that may be administratively approved. To be granted administrative approval, all proposed changes must meet the published *Design Standards*. Projects granted administrative approval do not need to appear before the Commission for a Certificate of Appropriateness.

The HPO or relevant department director reserves the right to refer improvements that are eligible for administrative approval to the Landmark Commission.

Appeals

If the Landmark Commission (or the HPO where administrative approval is allowed) denies an application, a modified application may be resubmitted by the next deadline. This will constitute a new case for consideration at a future Commission hearing. If the Commission denies the request, the applicant may appeal to the Zoning Board of Adjustment (ZBA). Requests to appeal the Landmark Commission’s decisions are submitted to the HPO. See “Permitting and Appeals Process” on page A-26 of the appendix for a flow chart of the process.

Other Permits or Applications Reviewed by the Landmark Commission

The Landmark Commission also reviews the following types of changes involving locally-designated individual historic landmarks and properties in locally-designated historic districts:

- Requests for local designation of individual landmarks and historic districts
- Applications for Specific Use Permits (SUPs)
- Licenses to Use the City right-of-way
- Change of zoning requests
- Variance requests

The Landmark Commission will recommend approval (sometimes with conditions) or denial prior to Planning Commission, ZBA or City Council action. The Planning Commission, ZBA or Council are not required to act according to the Landmark Commission recommendation.

Applicants are encouraged to meet with the HPO or designated staff in the Planning Division to receive instructions for making applications to all relevant boards and commissions.

Chart 1.3: Guide for Administrative Approval

Item	Material	Administrative Approval?	Commission Review?	Comments
PORCHES AND DECKS				
Rear porches or decks - new or alterations	Wood	Yes - If not visible from the public right-of-way	If visible from the public right-of-way	New deck must be of a style compatible with the main structure. Deck may not permanently alter or damage the main structure
Front Porch	Wood	Yes	If change in material or design	Need clear evidence of original design
WINDOWS AND DOORS				
Replacement windows and doors	Wood	Yes	If primary facade or change in materials	Secondary and rear facades only. New windows and doors must match existing historic feature in material and design
MINOR ARCHITECTURAL CHANGES				
Replacement of missing architectural features	Wood	Yes	Change in materials. Lack of clear evidence or photographs	Need clear evidence of original design. Replacement shutters must match the original size and scale
Installation of "Hardiepanel" on skirt on high raised buildings	"Hardiepanel" smooth finish	Yes	Wood-grained finish	4' X 8' smooth finish sheets with applied 1" X 2" wood battens at twelve inches (12") on center
Alterations to non-historic residential buildings		Yes	HPO determines that the requested work does not conform to the Design Standards	Building must be deemed non-contributing or intrusion to the historic district. Must conform to the design standards
CHIMNEYS AND ROOFS				
New roofs	Match existing	Yes	Change in materials - does not meet the Design Standards	Select material and pattern that are historically appropriate to the house
Installation or removal of vent hoods. Removal of damaged or unstable secondary chimney	Metal	Yes	If primary chimney	Secondary chimney must be behind the roof peak
FENCES				
Front fences	Wood, metal	Yes	Change in height, materials or unusual design	Height not to exceed 48". Vinyl not permitted. Must conform to the Design Standards
New rear or side yard privacy fence	Cedar dog-ear pickets with lattice above	Yes	Change in height, materials or unusual design	Height not to exceed 48". Vinyl not permitted. Must conform to the Design Standards
SYNTHETIC SIDING (VINYL OR ALUMINUM)¹				
All new applications		No	Yes	Must go before Landmark Commission - color review for all new applications
Removal of synthetic siding		Yes	No	Check condition of historic wood material beneath
ADA/ACCESSIBILITY				
Ramps or lifts	Wood	Yes	Lifts visible from the city right-of-way	Should be placed on side or rear of structure if possible/met setbacks
SIGNAGE				
New		Yes - If no change in materials or size	If change in materials or allowable size	Accurate full color renderings submitted to HPO
WORK IN REAR YARDS				
Removal of dilapidated, non-historic rear yard secondary structure	Various	Yes	If historic or contributing structure	Submittal of photographs verifying condition of property
Minor alterations to accessory buildings	Various	Yes	If visible from the public right-of-way	Including garage doors, enclosure or foundations, access stairs to associated decks and porches
New rear yard accessory buildings and structures	Various	Yes	If significantly visible from the public right-of-way	Must conform to the Design Standards

¹See "Using Alternative Materials on a Historic Structure" on page 31 for more information on use of synthetic and imitation materials.

EXEMPTIONS AND BENEFITS

In addition to the responsibilities described in “The Design Review System” above, owners of historic properties are eligible for special exemptions and benefits to assist with preservation, maintenance and active use of their properties. Specific exemptions and benefits are summarized below.



LOCAL PROPERTY TAX EXEMPTION PROGRAM

The City has developed programs to promote rehabilitation of historic resources by freezing local property taxes at pre-improvement rates. Owners of income-producing properties with at least 10,000 square feet of gross leasable area that are locally-designated individual historic landmarks or contributing properties in locally-designated historic districts may apply for an ad valorem property tax exemption that applies to significant improvements.

STATE SALES TAX EXEMPTION PROGRAM

Repair and rehabilitation work on properties listed on the National Register of Historic Places may qualify for a state sales tax exemption. Labor to restore, repair or remodel an individual National Register Historic Landmark or property in a National Register Historic District is exempted from sales tax if the amount of the charge for labor is separately itemized.

FEDERAL HISTORIC REHABILITATION TAX CREDIT

Owners of historic structures may be eligible for a one-time federal income tax credit for costs associated with certified rehabilitation projects. The Historic Rehabilitation Tax Credit Program applies only to income producing properties such as multifamily and commercial buildings and is jointly administered by the National Park Service and IRS.

WINDSTORM EXEMPTION

Exemptions from the Texas Department of Insurance standards for windstorm resistance are available for qualified historic properties, including National Register eligible buildings. If a historic building is damaged during a storm, an owner may replace damaged windows, shutters, doors, and other character-defining elements with in-kind items even if they do not meet current building code requirements. The windstorm exemption does not offer a reduced rate for insurance coverage.

FEDERAL EMERGENCY MANAGEMENT AGENCY EXEMPTIONS

Owners of historic structures are exempt from most Federal Emergency Management Agency (FEMA) compliance requirements allowing substantial improvements to be undertaken without bringing the structure into compliance with current FEMA regulations. However, substantial alterations that would cause a historic structure to lose its integrity will invalidate any FEMA exemptions.

For purposes of the FEMA exemption, a historic structure means any structure that is:

- Individually listed in the National Register of Historic Places or preliminarily determined by the Secretary of the Interior as meeting listing requirements
- Certified or preliminarily determined by the Secretary of the Interior as contributing to the historical significance of a registered historic district or a district preliminarily determined to qualify
- Individually listed on the state inventory of historic places
- Individually listed as a local historic landmark

ENERGY CODE EXEMPTIONS

Section 101.2.2.3 of the International Energy Conservation Code® allows for exemptions from the Energy Code for historic structures. If a structure is recognized as historic by local and/or state jurisdictions, and/or is listed or determined eligible for listing in the National Register of Historic Places, compliance with the Energy Code “shall not be mandatory.”

Applying for Exemptions and Benefits

City Programs. For more information on incentive and benefit programs offered by the City of Galveston, contact the Department of Planning and Community Development at 409-797-3660.

State Programs. To obtain application forms for the state sales tax exemption program, visit:

<http://www.window.state.tx.us/taxinfo/taxforms/>

Applications for the windstorm exemption, called a WEA-1, can be obtained from the Galveston Historical Foundation (GHF) at 502 20th Street. Call the GHF at 409-765-7834 or visit their web site to set up an appointment:

<http://www.galvestonhistory.org/>

Federal Programs. For more information of federal incentive and benefit programs, visit:

<http://www.nps.gov/hps/tps/tax/incentives/index.htm>

DESIGN STANDARDS ORGANIZATION

The *Design Standards* are organized into chapters that apply to different types of projects. Some chapters apply to all projects, while others will be relevant only to specific situations. Each chapter is briefly summarized below.

CHAPTER 1 USING THE DESIGN STANDARDS

Galveston's older neighborhoods are unique and valued for their historic resources. The *Design Standards for Historic Properties* are a tool to guide improvements to locally-designated historic landmarks and properties in locally-designated historic districts. They inform a design review process that helps ensure that changes to the built environment will be sensitive to the community's historical legacy.

This chapter provides a guide to using the design standards. It describes the overall design review process of which the design standards are part, including applicable procedures for property owners and the public. It also includes information on how to use the standards and how to contact the Galveston Historic Commission. It also includes information on how to use the standards to guide property owners, requestors and permit preparers and applicants in Galveston.

In This Chapter

- Using the Design Standards 101
- Design Standards for All Historic Preservation Projects 102
- Design Standards for Residential Properties 103
- Design Standards for Commercial Properties 104
- Design Standards for Historic Districts 105
- Appendices 106

CHAPTER 2 DESIGN STANDARDS FOR ALL HISTORIC PRESERVATION PROJECTS

Preserving the integrity of properties identified as having historic significance is a fundamental goal for the City of Galveston. This means employing best practices in property ownership that maintain the top character-defining features of individual historic buildings, sites features and other objects of historic significance, as well as maintaining the context in which they exist.

This chapter presents an overview of historic preservation principles that apply to historic properties, including best practices and requirements and procedures for applying the standards. It also provides information on how to use the standards and how to contact the Galveston Historic Commission. It also includes information on how to use the standards to guide property owners, requestors and permit preparers and applicants in Galveston.

This chapter provides an overview of historic preservation principles that apply to historic properties, including best practices and requirements and procedures for applying the standards. It also provides information on how to use the standards and how to contact the Galveston Historic Commission. It also includes information on how to use the standards to guide property owners, requestors and permit preparers and applicants in Galveston.

In This Chapter

- General Preservation Principles 101
- Historical Significance 102
- Historic Properties 103
- Historic Districts 104
- Historic Landmarks 105
- Historic Sites 106
- Historic Structures 107
- Historic Landscapes 108
- Historic Objects 109
- Historic Resources 110
- Historic Preservation 111
- Historic Preservation Process 112
- Historic Preservation Review 113
- Historic Preservation Standards 114
- Historic Preservation Guidelines 115
- Historic Preservation Best Practices 116
- Historic Preservation Requirements 117
- Historic Preservation Procedures 118
- Historic Preservation Information 119
- Historic Preservation Resources 120
- Historic Preservation Contacts 121
- Historic Preservation Glossary 122
- Historic Preservation Index 123

CHAPTER 3 DESIGN STANDARDS FOR RESIDENTIAL PROPERTIES

Galveston includes a diverse range of historic residential properties and districts. It is important for new construction in historic residential districts to reinforce preservation objectives.

This chapter builds on the general preservation standards presented in Chapter 2 with specific design standards for residential properties in locally-designated historic districts. It also includes information on how to use the standards and how to contact the Galveston Historic Commission. It also includes information on how to use the standards to guide property owners, requestors and permit preparers and applicants in Galveston.

This chapter builds on the general preservation standards presented in Chapter 2 with specific design standards for residential properties in locally-designated historic districts. It also includes information on how to use the standards and how to contact the Galveston Historic Commission. It also includes information on how to use the standards to guide property owners, requestors and permit preparers and applicants in Galveston.

In This Chapter

- Residential Development Patterns 101
- Design Standards for All Residential Properties 102
- Design Standards for Historic Residential Properties 103
- Design Standards for Historic Residential Properties 104
- Design Standards for Historic Residential Properties 105
- Design Standards for Historic Residential Properties 106
- Design Standards for Historic Residential Properties 107
- Design Standards for Historic Residential Properties 108
- Design Standards for Historic Residential Properties 109
- Design Standards for Historic Residential Properties 110
- Design Standards for Historic Residential Properties 111
- Design Standards for Historic Residential Properties 112
- Design Standards for Historic Residential Properties 113
- Design Standards for Historic Residential Properties 114
- Design Standards for Historic Residential Properties 115
- Design Standards for Historic Residential Properties 116
- Design Standards for Historic Residential Properties 117
- Design Standards for Historic Residential Properties 118
- Design Standards for Historic Residential Properties 119
- Design Standards for Historic Residential Properties 120
- Design Standards for Historic Residential Properties 121
- Design Standards for Historic Residential Properties 122
- Design Standards for Historic Residential Properties 123

CHAPTER 4 DESIGN STANDARDS FOR COMMERCIAL PROPERTIES

Galveston features an intact historic commercial core centered around the Strand/Mechanic Historic District. Historic commercial buildings are also located in commercial centers and in some residential historic districts. Historic commercial properties require careful stewardship. It is also important for new construction in historic commercial settings to reinforce preservation objectives.

This chapter builds on the general preservation standards presented in Chapter 2 with specific design standards for commercial properties in historic commercial settings to reinforce preservation objectives.

This chapter builds on the general preservation standards presented in Chapter 2 with specific design standards for commercial properties in historic commercial settings to reinforce preservation objectives.

In This Chapter

- Historic Commercial Properties 101
- Design Standards for All Commercial Properties 102
- Design Standards for Historic Commercial Properties 103
- Design Standards for Historic Commercial Properties 104
- Design Standards for Historic Commercial Properties 105
- Design Standards for Historic Commercial Properties 106
- Design Standards for Historic Commercial Properties 107
- Design Standards for Historic Commercial Properties 108
- Design Standards for Historic Commercial Properties 109
- Design Standards for Historic Commercial Properties 110
- Design Standards for Historic Commercial Properties 111
- Design Standards for Historic Commercial Properties 112
- Design Standards for Historic Commercial Properties 113
- Design Standards for Historic Commercial Properties 114
- Design Standards for Historic Commercial Properties 115
- Design Standards for Historic Commercial Properties 116
- Design Standards for Historic Commercial Properties 117
- Design Standards for Historic Commercial Properties 118
- Design Standards for Historic Commercial Properties 119
- Design Standards for Historic Commercial Properties 120
- Design Standards for Historic Commercial Properties 121
- Design Standards for Historic Commercial Properties 122
- Design Standards for Historic Commercial Properties 123

CHAPTER 5 LOCAL HISTORIC DISTRICTS

Galveston's locally-designated historic districts comprise a significant portion of the western part of the city. They range from the grand commercial structures of the Strand/Mechanic District to the more modest residential context of the East Bayou Historic District. The community seeks to preserve and promote the key features and general design traditions of each of its local historic districts.

This chapter provides context-specific information to assist applicants of the design standards in their applications to historic districts. It also includes information on how to use the standards and how to contact the Galveston Historic Commission. It also includes information on how to use the standards to guide property owners, requestors and permit preparers and applicants in Galveston.

This chapter provides context-specific information to assist applicants of the design standards in their applications to historic districts. It also includes information on how to use the standards and how to contact the Galveston Historic Commission. It also includes information on how to use the standards to guide property owners, requestors and permit preparers and applicants in Galveston.

In This Chapter

- East Bayou Historic District 101
- East Bayou Historic District 102
- East Bayou Historic District 103
- East Bayou Historic District 104
- East Bayou Historic District 105
- East Bayou Historic District 106
- East Bayou Historic District 107
- East Bayou Historic District 108
- East Bayou Historic District 109
- East Bayou Historic District 110
- East Bayou Historic District 111
- East Bayou Historic District 112
- East Bayou Historic District 113
- East Bayou Historic District 114
- East Bayou Historic District 115
- East Bayou Historic District 116
- East Bayou Historic District 117
- East Bayou Historic District 118
- East Bayou Historic District 119
- East Bayou Historic District 120
- East Bayou Historic District 121
- East Bayou Historic District 122
- East Bayou Historic District 123

APPENDICES

A range of administrative procedures and historic background information supports effective use of the *Design Standards for Historic Properties*.

The appendices provide historical information including a description of Galveston's historic architecture, a glossary, and a list of historic landmarks. The appendices also include information on the design review process for improvements in historic districts including a permit process flow chart and guidance on how to present a project proposal to the Galveston Historic Commission.

Listing of Appendices

- Appendix A - Historic Architecture Styles 101
- Appendix B - Glossary of Terms 102
- Appendix C - List of Historic Landmarks 103
- Appendix D - List of Historic Landmarks 104
- Appendix E - List of Historic Landmarks 105
- Appendix F - List of Historic Landmarks 106
- Appendix G - List of Historic Landmarks 107
- Appendix H - List of Historic Landmarks 108
- Appendix I - List of Historic Landmarks 109
- Appendix J - List of Historic Landmarks 110
- Appendix K - List of Historic Landmarks 111
- Appendix L - List of Historic Landmarks 112
- Appendix M - List of Historic Landmarks 113
- Appendix N - List of Historic Landmarks 114
- Appendix O - List of Historic Landmarks 115
- Appendix P - List of Historic Landmarks 116
- Appendix Q - List of Historic Landmarks 117
- Appendix R - List of Historic Landmarks 118
- Appendix S - List of Historic Landmarks 119
- Appendix T - List of Historic Landmarks 120
- Appendix U - List of Historic Landmarks 121
- Appendix V - List of Historic Landmarks 122
- Appendix W - List of Historic Landmarks 123

Chapter 1. Using the Design Standards

This chapter provides a guide to the design review process and use of the *Design Standards*. It also includes a summary of the application process for improvements to locally-designated individual historic landmarks and properties in locally-designated historic district.

Chapter 2. Design Standards for All Historic Preservation Projects

This chapter provides general *Design Standards* for improvements to locally-designated individual historic landmarks and contributing properties in locally-designated historic districts. The standards in this chapter do not apply to new construction.

Chapter 3. Design Standards for Residential Properties

This chapter builds on the general preservation standards presented in Chapter 2 with specific *Design Standards* for residential properties, including new residential construction in locally-designated historic districts.

Chapter 4. Design Standards for Commercial Properties

This chapter builds on the general preservation standards presented in Chapter 2 with specific design standards for commercial properties, including new commercial construction in locally-designated historic districts.

Chapter 5. Design Standards for Historic Districts

This chapter provides a summary of design traditions, concerns and objectives for Galveston's four historic locally-designated historic districts. It also includes additional context-specific design standards for the Strand/Mechanic Historic District.

Appendices

The Appendices provide supplementary information to support the historic *Design Standards*. They include Historic Architectural Styles, a glossary, the Secretary of the Interior's Standards for the Treatment of Historic Properties and information on application procedures.

DESIGN STANDARDS COMPONENTS

The individual design standards in this document use a standard format with several key components. All components of a standard are used in determining appropriateness. The key components of a typical design standard are illustrated below.

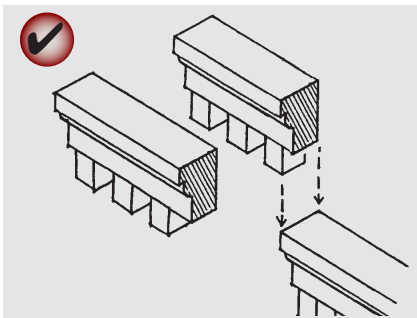
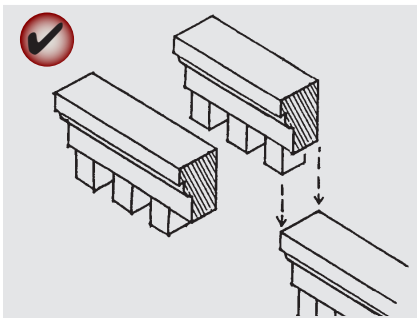
Sample Design Standard	Components of the Standard
<h2>Architectural Details</h2>	<p>← Design Topic: Describes the topic area that the standard falls within.</p>
<p>Architectural details contribute to the character of a structure and some details are associated with specific architectural styles. Those details that are key character-defining features should be preserved. The method that requires the least intervention is preferred.</p>	<p>← Policy Statement: Explains the desired outcome and provides a basis for the standards that follow. If no standards address a specific design issue, the policy statement will be used to determine appropriateness.</p>
<h3>1.1 Preserve significant stylistic and architectural features.</h3>	<p>← Design Standard: Describes the desired design outcome. Standards are sequentially numbered within each chapter.</p>
<p><i>Appropriate</i></p> <ul style="list-style-type: none"> • Employ preventive maintenance measures such as rust removal and repainting to protect historic details and their finishes. • Patch, piece-in, splice, consolidate or otherwise upgrade deteriorated features using recognized preservation methods. <p><i>Inappropriate</i></p> <ul style="list-style-type: none"> • Do not remove or alter architectural details that are in good condition or that can be repaired. 	<p>← Additional Information: Provides bullet lists of appropriate and inappropriate strategies for meeting the intent of the design standard.</p>
 <p>Employ preventive maintenance measures such as rust removal and repainting to protect historic details and their finishes.</p>	 <p>← Images: Clarify the intent of the standard by illustrating appropriate and inappropriate design solutions.</p> <p>✓ Appropriate: Images marked with a check illustrate appropriate design solutions.</p> <p>✗ Inappropriate: Images marked with an X illustrate inappropriate design solutions.</p>
 <p>Patch, piece-in, splice, consolidate or otherwise upgrade deteriorated features using recognized preservation methods.</p>	

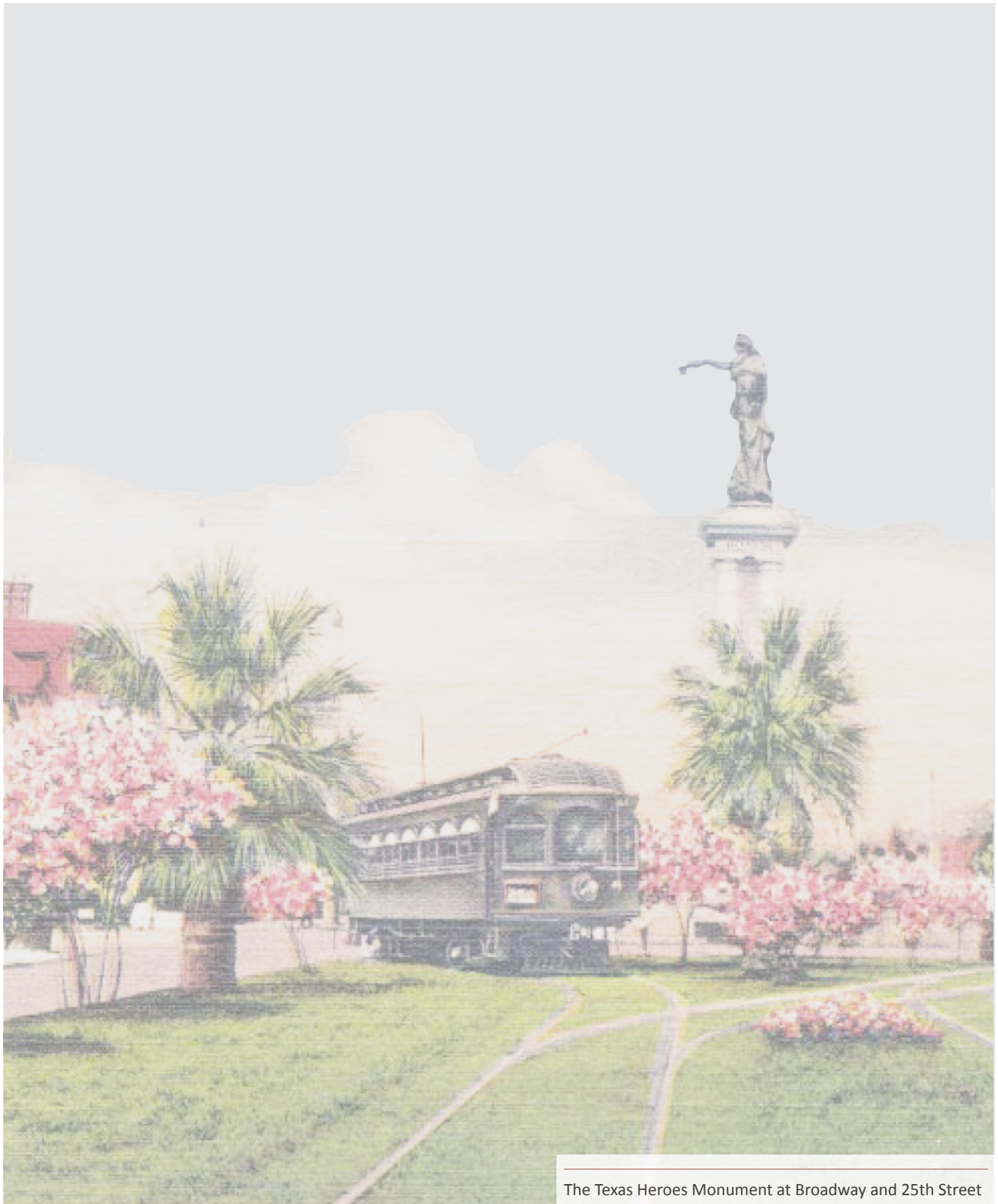

The Texas Heroes Monument at Broadway and 25th Street

CHAPTER 2

DESIGN STANDARDS FOR ALL HISTORIC PRESERVATION PROJECTS

Preserving the integrity of properties identified as having historic significance is a fundamental goal for the City of Galveston. This means employing best practices in property stewardship that maintain the key, character-defining features of individual historic buildings, sites features and other objects of historic significance, as well as maintaining the context in which they exist.

This chapter presents an overview of historic preservation principles that apply to any historic property, including basic maintenance and repair, replacement and reconstruction and compatible additions. It also provides guidance on how to plan a preservation project and outlines different treatment categories for historic properties.

These standards for the preservation of historic resources apply to locally-designated individual historic landmarks and contributing properties in locally-designated historic districts. They do not apply to non-contributing structures in locally-designated historic districts.

The first section contains general standards for treatment of many of the key features that are found among most historic structures in Galveston. For each of the features discussed, individual standards follow the preferred sequence of treatments summarized in “Preservation Project Planning Steps” on page 26.



In This Chapter

General Preservation Principles	24
Standards for the Treatment of Historic Features	30
Materials and Finishes.....	30
Building Elements	37
Architectural Details	45
Additional Standards for Historic Buildings	47
Storm-Safety Features on Historic Buildings	47
Adaptive Reuse	49
Historic Additions	50
Accessibility	50
Utility Equipment.....	52
Sustainability Standards for Historic Properties	53
Planning a Rehabilitation Project for Energy Efficiency	53
Maintaining the Inherent Energy Efficiency of a Historic Building	58
Enhancing Energy Performance of Historic Structures ...	59
Using Energy-Generating Technologies	61

GENERAL PRESERVATION PRINCIPLES

A number of general principles apply to the preservation of both commercial and residential properties. These principles are briefly summarized below. The information and charts on the following pages augment the general preservation principles with more specific guidance for evaluating the appropriateness of projects involving historic properties.



The basic form and materials of a building, as well as its architectural details, are a part of the historic character.

Historic Alterations

The *Design Standards* define and encourage respect for the basic architectural similarities that contribute to the character historic properties and districts.

Historically, building modifications were made as needs changed. Many of these alterations were sympathetic to the original character of the structure and may have since obtained significance themselves. Others, however, were unsympathetic changes that eroded the historic integrity of a building. The *Design Standards* are intended to maintain existing original architectural fabric and remove any alterations that have compromised a building's architectural integrity.

RESPECT THE HISTORIC CHARACTER OF A PROPERTY.

- The basic form and materials of a building, as well as its architectural details, are a part of the historic character.
- Do not try to change the style of a historic resource or make it look older than its actual age.
- Confusing the character by mixing elements of different styles or periods can adversely affect the historic significance of the property.

SEEK USES THAT ARE COMPATIBLE WITH THE HISTORIC CHARACTER OF THE PROPERTY.

- Converting a building to a new use different from the original use is considered to be an “adaptive reuse,” and is a sound strategy for keeping a building in service. For example, converting a gas station to a coffee shop is an adaptive use. A good adaptive use project retains the historic character of the building while accommodating a new function.
- Every reasonable effort should be made to provide a compatible use for the building that will require minimal alteration to the building and its site.
- Changes in use requiring the least alteration to significant elements are preferred. In most cases designs can be developed that respect the historic integrity of the building while also accommodating new functions.

MAINTAIN SIGNIFICANT FEATURES AND STYLISTIC ELEMENTS.

- Distinctive stylistic features and other examples of skilled craftsmanship should be preserved. The best preservation procedure is to maintain historic features from the outset to prevent the need for repair later. Appropriate maintenance includes rust removal, caulking and repainting.
- These features should not be removed.

REPAIR DETERIORATED HISTORIC FEATURES AND REPLACE ONLY THOSE ELEMENTS THAT CANNOT BE REPAIRED.

- Upgrade existing materials, using recognized preservation methods whenever possible. If disassembly is necessary for repair or restoration, use methods that minimize damage to original materials and facilitate reassembly.

When applying these basic preservation principles, some questions may arise about how they relate to conditions in which properties are badly deteriorated, and that may be unsafe. Some may argue that, in an urgent situation, they should not be held to these standards. In other cases, they may contend that complying with them is not feasible. Fortunately, many products and trades have responded to the preservation market, and now offer products and services that are compatible with historic preservation principles. The city seeks to provide assistance to property owners in meeting their individual needs while also upholding the formally adopted policies for preservation.

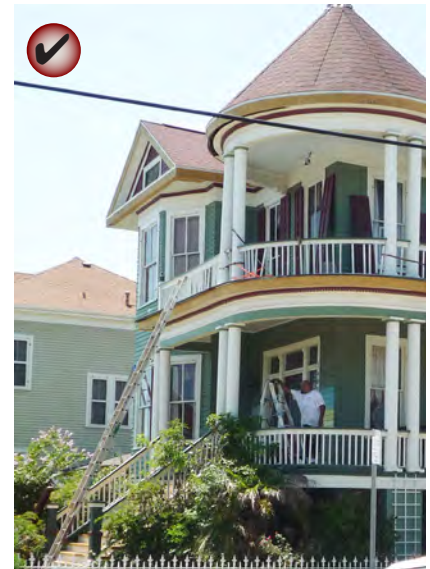

Repair deteriorated historic features and replace only those elements that cannot be repaired.

Sample Historic Rehabilitation Project

The historic house at 1201 25th Street in the Silk Stocking Historic District was sensitively rehabilitated to be compatible with the surrounding historic district.

Before



After



Preservation Project Planning Steps

When planning a preservation project, it is important to determine historic significance, assess integrity and determine program requirements prior to outlining an appropriate treatment strategy that will inform the overall project scope. Follow the steps below when planning a preservation project.

Step 1: Why is the building significant?



Historic Significance. Understanding the history of a building and identifying its key features will help determine to what degree the property should be preserved as it is, or where there may be opportunities for compatible alterations to occur. A property is considered to have historic significance if it meets a defined age threshold, and meets adopted criteria for determining significance.

Step 2: What is the condition of the building and its key features?



Integrity. The condition of the building and its features contribute to the overall significance of the property. A building with historic integrity has a sufficient percentage of key character-defining features and characteristics from its period of significance which remain intact. These key elements allow a building to be recognized as a product of its time.

Step 3: What is the desired project?

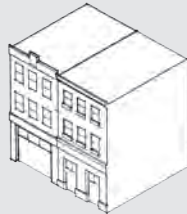

Program Requirements. Are functional improvements needed? Or is the preservation of key features the objective? If restoring features is the focus, then other alternatives may not be necessary, but if some functional improvements are needed, then compatible alterations and/or additions may be indicated.

Step 4: What is the treatment strategy?

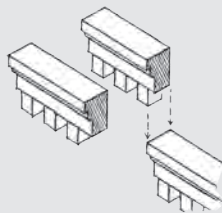

Treatment Strategy. An appropriate treatment strategy may be devised once historic significance, integrity and program requirements have been determined. A preservation project may include a range of activities, such as maintenance of existing historic elements, repair of deteriorated materials, the replacement of missing features and construction of a new addition. Note, that while an overall treatment for the building may be used, a different treatment may be applied to a specific building element or component. Additional information on treatment strategies is provided on the next page.

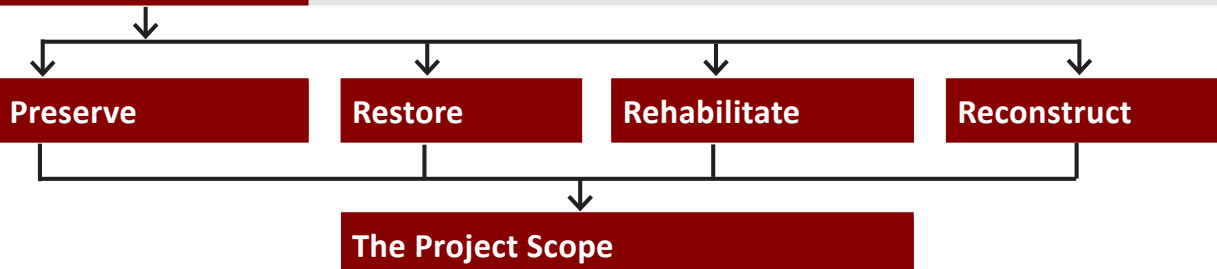

Accepted Treatments

The following is a list of four approaches that are appropriate for treating historic properties.

Preservation is the act or process of applying measures to sustain the existing form, integrity and material of a building. Some work focuses on keeping a property in good working condition by repairing features as soon as deterioration becomes apparent, using procedures that retain the original character and finish of the features. Property owners are strongly encouraged to maintain properties in good condition.

Restoration is the act or process of accurately depicting the form, features and character of a property as it appeared in a particular time period. It may require the removal of features from outside the restoration period.

Rehabilitation is the process of returning a property to a state that makes a contemporary use possible while still preserving those portions or features of the property which are significant to its historical, architectural and cultural values. Rehabilitation may include a change in use of the building or additions. This term is the broadest of the appropriate treatments and is often used in the standards with the understanding that it may also involve other appropriate treatments.

Reconstruction is the act or process of depicting, by means of new construction, the form, features and detailing of a non-surviving site, landscape, building, structure or object for the purpose of replicating its appearance at a specific time and in its historic location.

Combining Treatments

While these terms are used interchangeably in informal conversation, the more precise meanings are used when describing the overall strategy for a contributing property.

For many improvement projects in Galveston a rehabilitation approach will be the overall strategy. Within that, however, there may be a combination of these approaches as they relate to specific building components. For example, a surviving cornice may be preserved, a storefront base that has been altered may be restored, and a missing kickplate may be reconstructed.

Inappropriate Treatments

The following approaches are not appropriate for historically significant properties.

Remodeling is the process of changing the historic design of a building. The appearance is altered by removing original details and by adding new features that are out of character with the original. Remodeling of a historic structure is inappropriate.

Deconstruction is the process of dismantling a building such that the individual material components and architectural details remain intact. This may be employed when a building is relocated or when the materials are to be reused in other building projects. Deconstruction may be a more environmentally responsible alternative to conventional demolition. However, it is an inappropriate treatment for a building of historic significance.

Preferred Sequence of Improvements

With an understanding of overall treatment strategies for historic properties, how may work be planned for specific features? Maintaining a high degree of integrity for a property is important, so it is always best to repair a feature rather than replace it. Of course, the first step should be to simply keep it in good condition, using accepted maintenance procedures. However, if the feature is in disrepair, then repair is preferred over replacement as it will help to retain a higher degree of integrity. The chart below lists the preferred sequence of improvement actions in order of preference. The design standards follow this sequence.

1. Preserve

If a feature is intact and in good condition, maintain it as such.



2. Repair

If the feature is deteriorated or damaged, repair it to its original condition.



3. Reconstruct

If the feature is missing entirely, reconstruct it from appropriate evidence. If a portion of a feature is missing, it can also be reconstructed.



4. Replace

If it is not feasible to repair the feature, then replace it with one that is a simplified interpretation of the original (e.g., materials, detail, finish). Replace only that portion which is beyond repair.



5. Compatible Alteration

If a new feature or addition is necessary, design it in such a way as to minimize the impact on original features. It is also important to distinguish new features from original historic elements.

Locating Façade Improvements

For most historic resources, the front façade is the most important to preserve intact. Alterations are rarely appropriate. Many side walls are also important to preserve where they are highly visible from the street. By contrast, portions of a side wall that are not as visible may be less sensitive to change. The rear wall is usually the least sensitive, and alterations can occur more easily without causing negative effects to the historic significance of the property.

An illustrated evaluation of appropriate improvement or alteration locations for a sample residential and sample commercial building is provided on this page.

Residential Building

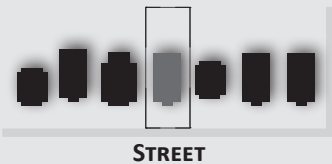

Commercial Building

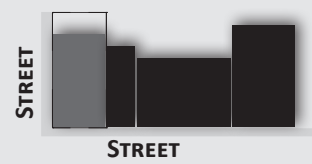

Location A: Primary Façade

Preservation and repair of features in place is the priority. This is especially important at the street level and in locations where the feature is highly visible.

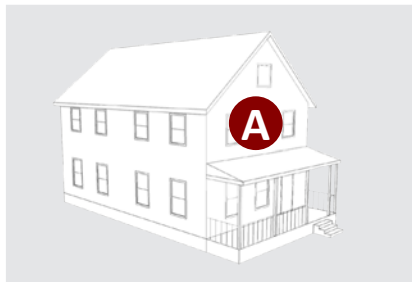

Location B: Highly Visible Secondary Wall

Preservation and repair in place is the priority.

Location C: Less Visible Secondary Wall

Preservation is still preferred but additional flexibility exists for compatible replacement or alteration.

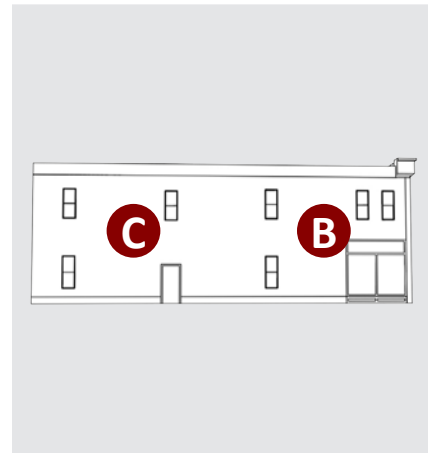
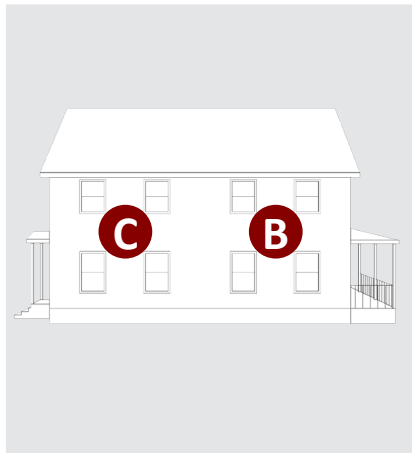

Location D: Not Typically Visible Rear Façade

More flexibility in treatment may be considered, especially for compatible replacement or alteration that is not visible from the street.

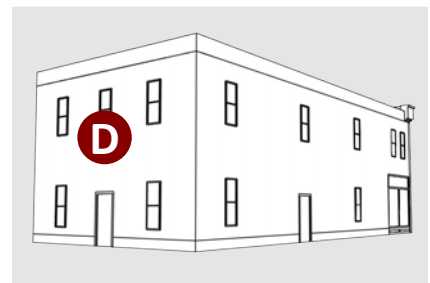

STANDARDS FOR THE TREATMENT OF HISTORIC FEATURES

Historic building features include architectural details, materials and specific building elements such as doors and windows. The proper treatment and preservation of such features is an important objective for historic properties in Galveston.



Repair deteriorated building materials.

The standards in this section apply to all projects involving work on a locally-designated individual historic landmark or a contributing structure in a locally-designated historic district. They do not apply to new construction in a locally-designated historic district. Refer to “Preferred Sequence of Improvements” on page 28 for additional guidance on appropriate treatment strategies.

Materials and Finishes

Primary historic building materials should be preserved in place whenever feasible. If the material is damaged, then limited replacement which matches the original should be considered. These materials should never be covered or subjected to harsh cleaning treatments. Preserving original building materials and limiting replacement to only pieces which are deteriorated beyond repair reduces the demand for, and environmental impacts from, the production of new materials and thus is sound sustainability policy.

Primary historic building materials found in Galveston include wood, stone, brick, metal, stucco, plaster and concrete. Such materials should be preserved and rehabilitated whenever possible.

2.1 Preserve original building materials.

Appropriate

- Repair deteriorated building materials by patching, piecing-in, consolidating or otherwise reinforcing the material.
- Remove only those materials which are deteriorated, and beyond reasonable repair.

Inappropriate

- Do not remove original materials that are in good condition (the Landmark Commission requires property owners to demonstrate that existing materials cannot be reasonably repaired prior to granting approval to remove original materials).



The façades of some historic commercial buildings in Galveston use stucco over brick to create the appearance of stone.

Using Alternative Materials on a Historic Structure

The Design Standards sometimes refer to the use of alternative materials when describing the appropriate treatment of historic building features and components such as moldings, windows, siding and other architectural details.

An alternative material is one which is different from that used originally for a specific application. Such materials may also be called “substitute”, “replacement”, “synthetic” or “imitation” materials, and can include:

- Vinyl siding or fencing
- PVC decking or fencing
- Aluminum siding
- HardiePlank siding
- Cementitious fiber siding
- Spray-on coatings
- Synthetic stucco
- Panelized brick
- Other non-original materials



Substitute materials may also include materials used to replace historic architectural features such as a resin-cast cornice used in place of a stamped metal cornice. In other cases, an alternative material may be traditional when used for other applications, but new for the particular detail being considered. Using wood to replace an original stamped-metal cornice is an example.

Alternative materials may be considered by the Landmark Commission on a case-by-case basis as replacement materials or for use on a new addition or new building in a historic district. The Commission will consider factors including:

Potential Impact on Historic Significance. Removing original material diminishes the integrity of a historic property by reducing the percentage of building fabric that remains from the period of historic significance. Retaining the original material is always preferred. If this is not feasible, alternative materials may be considered. When used, an alternative material should convey the character, including detail and finish, of the original to the greatest extent feasible.

Durability. An alternative material should have proven durability in similar applications. While some new materials are very sturdy, others may degrade quickly and can be difficult to repair.

Appearance. An alternative material should have a similar profile, texture and finish as the original material. Some synthetic siding has an exaggerated, rusticated finish that is an inaccurate representation of original clapboard, and many vinyl products have a sheen that is out of character with that of painted wood and metal.

Location. Up close, it is easier to identify some alternative materials due to differences in texture, finish and feel. Tapping on a hollow plastic column or fence does not convey the same experience as the original. For this reason, locations that are more remote are better. Similarly, use of alternative materials is more appropriate on non-primary façades. See “Locating Façade Improvements” on page 29 for more information.

Cost. Some alternative materials are promoted because their initial costs appear to be less than repairing or replacing the original. When the other qualities of appearance and durability are proven, then the less expensive option may be appropriate. However, long-term, “life cycle” costs should also be weighed. Sometimes, the up-front saving is deceptive.

Environmental Impacts. The potential environmental impacts of alternative materials should also be considered including impacts associated with manufacture, transport, installation and ability to recycle.

Interaction with Historic Building Materials. Some alternative materials may interact negatively with historic materials. For example, some metals may corrode and stain original materials and some window and siding materials may expand and contract with temperature changes in ways that degrade weather-protection properties.

See “Interpreting the Design Standards” on page 16 for more information. Also see design standard 3.6 on page 73 for information on alternative fencing materials.



Consider removing later covering materials that have not achieved historic significance.



Before: Original siding is obscured.



After: Original siding is revealed.

2.2 Preserve the visibility of original historic materials.

Appropriate

- Consider removing later covering materials that have not achieved historic significance.
- Once a non-historic siding is removed, repair the original, underlying material.
- Carefully remove a later stucco finish if the process does not damage the underlying original building material.

Inappropriate

- Do not remove a later stucco covering if the process may damage the underlying original building material. Test the stucco to assure that the original material underneath will not be damaged.
- Do not cover or obscure original building materials.
- Do not add another layer of new material if a property already has a non-historic building material covering the original, as doing so would further obscure the original.

2.3 Use original materials to replace damaged materials on primary surfaces.

Appropriate

- Use original materials to replace damaged building materials on a primary façade. If the original material is wood clapboard, for example, then the replacement material should be wood that matches the original in finish, size and the amount of exposed lap.
- Replace only the amount of material required. If a few boards are damaged beyond repair, for example, then only they should be replaced, rather than the entire wall.
- Consider using an alternative material if a wood porch or deck floor needs replacement because of significant deterioration.

Inappropriate

- Do not replace building materials on the primary façade, such as wood siding and masonry, with alternative or imitation materials.

Maybe Considered on a Case-by-Case Basis by the Landmark Commission

- The Commission may consider alternative materials located on a residential accessory building, addition or rear façade.
- The Commission may consider alternative or imitation materials that match the style and detail of the original material to replace materials located above the pedestrian-level of a commercial building. For example, alternative materials may be considered for replacement of cornice elements. See “Using Alternative Materials on a Historic Structure” on page 31 for more information.

2.4 When replacing material on a non-primary surface, match the original material in composition, scale and finish.

Appropriate

- Use original materials to replace damaged materials on a non-primary façade.
- Use green building materials, such as those made with renewable and local resources to replace damaged materials on a non-primary façade if they do not impact the integrity of the building or its key features.

May be Considered on a Case-by-Case Basis by the Landmark Commission

- Alternative or imitation materials that match the style and detail of the original material to replace damaged non-primary building materials. See “Using Alternative Materials on a Historic Structure” on page 31 for more information.

2.5 Use the gentlest means possible to clean façade materials.

Appropriate

- If cleaning is appropriate, a low pressure water wash is preferred. Chemical cleaning may be considered if a test patch is first reviewed and negative effects are not found.
- Perform a test patch to determine that the cleaning method will cause no damage to the material surface.

Inappropriate

- Do not use harsh cleaning methods, such as sandblasting, which can damage historic materials, changing their appearance.

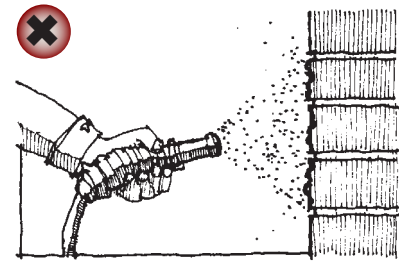

Harsh cleaning methods, such as sandblasting, can damage historic materials, changing their appearance. Such procedures are inappropriate.

Replacement Siding

Appropriate replacement siding preserves the key characteristics of the original siding:

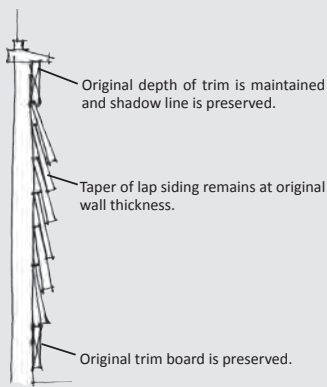

Inappropriate replacement siding:

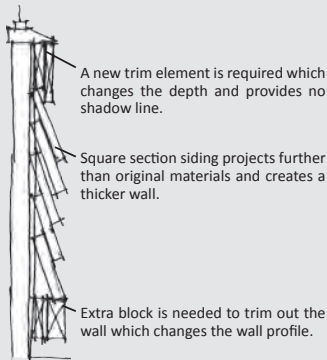

HISTORIC WOOD

Lap siding has always been the primary wood building material in Galveston. It was used historically for exterior siding, trim and ornamental details. Most houses have a horizontal 6' bevel siding that is applied in an overlap fashion (4 1/2" of the siding exposed). Vertical board and batten siding is also used.

Early woodwork should be retained, and, if necessary repaired. When properly maintained, original wood has a long lifespan.

2.6 Protect wood features from deterioration.

Appropriate

- Maintain paint on wood surfaces.
- Provide proper drainage and ventilation to minimize decay.
- Maintain protective coatings to retard deterioration and ultraviolet damage.



Historically, most wood surfaces on the exterior of a building were painted to protect them from weathering.

HISTORIC MASONRY

Brick, stone, terra cotta, stucco and concrete are the primary historic masonry building materials in Galveston. They are used as building walls, site walls, steps, and walkways. Historic masonry and concrete should be repaired and preserved whenever possible.

2.7 Preserve original masonry materials.

Appropriate

- Preserve masonry features that define the overall historic character, such as walls, cornices, pediments, steps and foundations.

Inappropriate

- Avoid rebuilding a major portion of exterior masonry walls that could be repaired.

2.8 Do not paint brick or stone that was not painted historically.

Appropriate

- Maintain the natural uncovered water-protective layer, or patina, to protect masonry from the elements.

Inappropriate

- Do not paint masonry walls (this can seal in moisture, which may cause extensive damage over time).

2.9 Re-point deteriorated masonry mortar joints.

Appropriate

- Duplicate original mortar in strength, composition, color and texture.
- Duplicate the mortar joints in width and profile.

Inappropriate

- Avoid using mortar with a high Portland cement content, which will be substantially harder than the original.

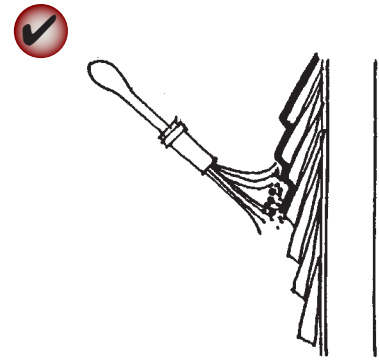

Maintain protective coatings to retard deterioration and ultraviolet damage.

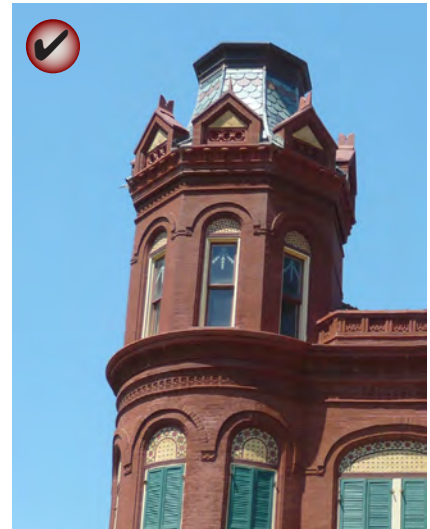

Preserve and repair historic masonry wherever possible.



Re-point mortar joints where there is evidence of deterioration.



Maintain protective coatings, such as paint, on exposed metals.

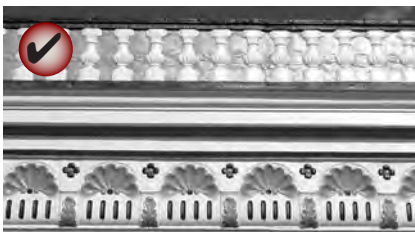

Preserve significant architectural metal features.

Exterior Painting and Colors

The Landmark Commission does not review exterior paint colors in residential historic districts but does review them in commercial historic districts as described on page 114.

When selecting colors, it may be helpful to consider historic color schemes on your street and block. Generally, a simple color scheme that does not include very dark colors or stained surfaces is preferable. White with green shutters or soft earth tones with white trim and dark shutters are often compatible color combinations.

Studies on paint colors used in 19th and early 20th Century Galveston are available from the Galveston Historical Foundation.

HISTORIC METAL

Metals were used for a variety of applications including columns, roofs, fences and decorative features. They include cast iron, steel and copper. Traditional metals should be preserved.

2.10 Preserve significant architectural metal features.

Appropriate

- Provide proper drainage on metal surfaces to minimize water retention.
- Maintain protective coatings, such as paint, on exposed metals.

2.11 Repair metal features by patching, splicing or otherwise reinforcing the original metal whenever possible.

Appropriate

- When replacement is necessary the new metal shall be compatible with the original.

HISTORIC PAINT

Historically, most wood surfaces on the exterior of a building were painted to protect them from weathering. Concrete and stucco structures were also sometimes painted.

Note that all projects must meet lead-based paint requirements.

2.12 Plan repainting carefully.

Appropriate

- Always prepare a good substrate. Prior to painting, remove damaged or deteriorated paint only to the next intact layer, using the gentlest means possible.
- Use compatible paints. Some latex paints will not bond well to earlier oil-based paints without a primer coat.

Building Elements

Individual historic building elements should be repaired and preserved whenever possible.

HISTORIC WINDOWS

The character-defining features of a historic window should be preserved. Historic windows can be repaired by re-glazing and patching and splicing wood elements such as muntins, frame, sill and casing. Repair and weatherization is more energy efficient, and less expensive than replacement. If an original window cannot be repaired, new replacement windows should be in character with the historic building.

2.13 Preserve the functional and decorative features of a historic window.

Appropriate

- Preserve historic window features including the frame, sash, muntins, mullions, glazing, sills, heads, jambs, moldings, operation and groupings of windows.
- Repair, rather than replace, frames and sashes, whenever possible.

2.14 Maintain original window proportions and components.

Appropriate

- Preserve the position, number and arrangement of historic windows in a building wall (flexibility in modifying a window on the rear of a contributing structure may be considered. See “Locating Façade Improvements” on page 29 for more information).
- Maintain the original size, shape and number of panes.
- Repair and maintain windows regularly, including wood trim, glazing putty and glass panes.
- Maintain historic art or stained glass.

Inappropriate

- Do not enclose a historic window opening or add a new opening.
- Do not significantly increase the amount of glass on a primary façade as it will negatively affect the integrity of the structure.

2.15 Preserve the proportions of historic window openings.

Appropriate

- Restore altered window openings on primary façades to their original configuration, when feasible.

Inappropriate

- Do not reduce an original opening to accommodate a smaller window or increase it to accommodate a larger window.



Preserve the position, number and arrangement of historic windows in a building wall.

Commission Approval of Replacement Elements

When considering replacement of building elements such as windows, doors and columns, as well as architectural features, the Landmark Commission requires applicants to submit dimensioned drawings including details and finishes prior to installation. A sample of the replacement element or feature may also be required for review at the Commission hearing.

Windstorm Requirements

When a replacement is warranted note that a variety of wood windows are available that meet current wind load standards of the Texas Department of Insurance. Refer to Chapter 1, page 14 for additional information.

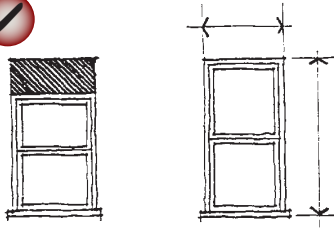

Preserve the size and proportion of a historic window opening.

2.16 Match replacement window design to the original.

Appropriate

- If the original is double-hung, use a double-hung replacement window, or a window that appears to be double-hung.
- Give special attention to matching the original design on a key character-defining façade.

2.17 Use materials that appear similar to the original when replacing a window.

Appropriate

- Use the same material as the original window, especially on character-defining walls (preferred approach).
- Consider an alternative material only if the appearance of the window components will match those of the original in dimension, profile and finish.
- Use clear window glazing that conveys the visual appearance of historic glazing (transparent low-e glass is preferred).

Inappropriate

- Do not use vinyl and unfinished metals as window materials.
- Do not use metallic or reflective window glazing.

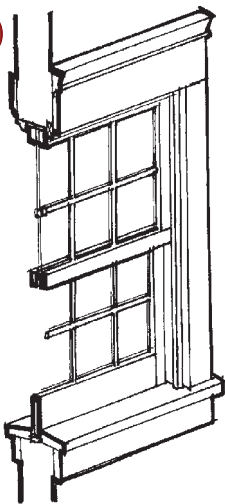

Match the design of a replacement window to the original.

2.18 Match the profile of the sash and its components to that of the original window.

Appropriate

- Maintain the profile depth of the sash, which steps back to the plane of the glass in several increments.



Place storm windows internally when feasible to avoid the impact upon external appearance (right). Use storm window inserts designed to match the original frame if placed externally (left).

2.19 Convey the character of historic sash divisions.

Appropriate

- Use genuine muntins that divide a window into smaller panes of glass on key walls and other highly visible places.

Inappropriate

- Do not use strips of material located between panes of glass to simulate muntins.

2.20 Enhance the energy efficiency of an existing historic window, rather than replace it.

Appropriate

- Add weather stripping and caulking around the window frame
- Install a storm window or insulated window shade
- Use clear UV films

HISTORIC SHUTTERS

Wood shutters are common to Galveston buildings and have been used since the 19th century. Shutters provide protection from the heat and provide some protection from storms. Louvered or slatted shutters, also known as blinds, were placed on most window openings and many door openings. The louvers were usually operable.

Also see “Storm-Safety Features on Historic Buildings” on page 47.

2.21 Maintain existing wood shutters.

Appropriate

- Preserve and repair existing wood shutters.

Inappropriate

- Do not remove original shutters. The shutters serve as accents, provide security, and offer protection against the climate.

2.22 Replace shutters where they previously existed.

Appropriate

- Use replacement shutters that match the size and scale of the original shutters.
- Match the width of new or replacement shutters to the width of the associated window or opening.
- Use replacement shutters that appear to be operable (even if they are not).
- Use replacement shutters that match the size of the window openings.

Inappropriate

- Do not use metal or vinyl storm shutters on windows that are visible from the street.
- Do not install shutters that are narrower than the associated window or opening.

May be Considered on a Case-by-Case Basis by the Landmark Commission

- The Landmark Commission may consider metal or vinyl shutters for windows that are not visible from the street.



Preserve and repair existing wood shutters.



Match the width of new or replacement shutters to the width of the associated window or opening.



Do not install shutters that are narrower than the associated window or opening.

Administrative Approval of Shutters

As summarized in “Administrative Approval” on page 16, Re-installation of louvered, wood shutters where evidence is clearly visible of previous existence, may be administratively approved by the HPO or designated City staff.



Install awnings to fit the window or door opening

AWNINGS

Awnings are appropriate for traditional locations such as over windows and doors or attached to porches. Awnings should only be applied when evidence suggests that they are appropriate. Evidence could include photographic documentation, physical evidence on the house, or identical houses with evidence. However, not all houses with awnings today had awnings historically. Thus, they are not always appropriate.

2.23 Use material for awnings that is durable and weather resistant.

Appropriate

- Use canvas or a similar woven material (preferred approach).
- Use awning colors that blend with colors of the structure.
- Consider using wood slat awnings if there is evidence that this awning type was used historically.

Inappropriate

- Do not use awning materials without proven durability or that have a gloss finish. See “Using Alternative Materials on a Historic Structure” on page 31 for more information on choosing appropriate materials.

2.24 Install an awning to fit the opening.

Appropriate

- Use a shed type awning for a rectangular window or door opening.
- Use curved or rounded awning forms over arched windows to match the curve of the opening.

Inappropriate

- Do not install a bubble or curved form awning on a rectangular opening.
- Do not install awnings that cover or conceal significant architectural details such as the window hood molding.
- Do not install awnings so that they cover transom lights or decorative mill work.

HISTORIC DOORS

There are many different types and styles of front doors on historic Galveston buildings. Most common are single doors with wood panels, wooden doors with glass lights, or wooden doors with sidelights and/or transoms.

The character-defining features of a historic door and its distinct materials and placement should be preserved. When a new door is needed, it should be in character with the building, especially when it is located on a primary wall.

2.25 Preserve the decorative and functional features of a primary entrance door.

Appropriate

- Repair locks and other hardware if feasible.
- Preserve original and decorative features, including door frames, sills, heads, jambs, moldings, detailing, transoms and flanking sidelights

Inappropriate

- Do not change the historic position of doors on primary façades.
- Do not add additional doors on primary façades.
- Do not enclose transoms or sidelights.

2.26 Maintain the original position and proportions of a historically significant door.

Inappropriate

- Do not alter the original size and shape of a historic door.

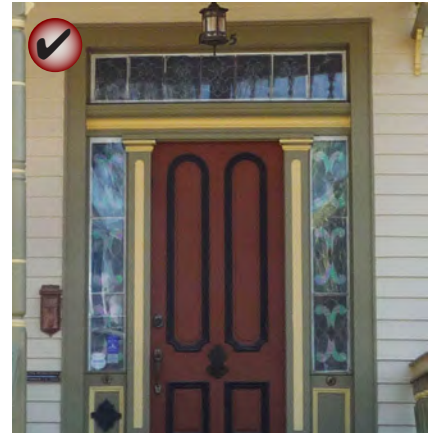

Preserve the decorative and functional features of a primary entrance door.

Typical Historic Door Types



DOOR WITH
TRANSOM AND
SIDELIGHTS



PANELED
DOOR WITH
GLASS PANES



PANELED
DOOR

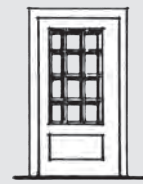

PERIOD REVIVAL
DOOR



COLONIAL RE-
VIVAL DOOR



HALF GLASS
DOOR



2.27 Repair or replace a damaged historic door to maintain its general historic appearance.

Appropriate

- Use materials that appear similar to that of the original.
- When replacing a historic door, use a design that appears similar to the original door.

Inappropriate

- Do not use solid core or flush doors.

2.28 If necessary, install simple screen doors.

Appropriate

- Use painted wooden screen and storm doors or louvered wooden doors that are backed with screening.

Inappropriate

- Do not use screen doors with highly decorative designs (metal scrollwork, etc.)



Use painted wooden screen and storm doors and louvered wooden doors that are backed with screening.



HISTORIC ROOFS

The character of a historic roof should be preserved, including its form and materials, whenever feasible.

2.29 Preserve the original roof form of a historic structure.

Appropriate

- Maintain the perceived line and orientation of the roof as seen from the street.

Inappropriate

- Avoid altering the angle of a historic roof.

2.30 Preserve the original eave depth of a roof.

Appropriate

- Maintain traditional overhangs because they contribute to the perception of the building's historic scale.

Inappropriate

- Do not cut back roof rafters and soffits.

2.31 Repair and maintain original roof materials wherever possible.

Appropriate

- Avoid removing historic roofing material that is in good condition.
- Patch and replace damaged areas of existing roof.
- Preserve decorative elements, including crests and chimneys.
- Retain and repair roof detailing, including gutters and downspouts.

Inappropriate

- Do not remove original roofing that can be repaired.



Preserve the original depth of eave overhangs on a historic roof.

Roof Color

When installing a new roof, choose a neutral color that will be adaptable to future color scheme changes on the building. Lighter roof colors reflect more heat, and may be considered when appropriate to the style of the building.

Windstorm Exemption

If a historic building is damaged during a storm, exemptions may be available from current building code requirements to allow for in-kind replacement of damaged building elements. See “Windstorm Exemption” on page 19 for more information.



Consider the architectural style of the structure when choosing roof replacement materials.

2.32 Use new roof materials that convey a scale and texture similar to those used traditionally.

Appropriate

- Consider the architectural style of the structure when choosing roof replacement materials.
 - Use materials with a similar texture, pattern and finish to the original roof material (materials with earth tones are generally best).
- Consider using a composition shingle roof.
 - Use a color similar to the original, or of the material in weathered condition.
- If installing a new metal roof, apply and detail it in a manner that is compatible with the historic character of surrounding structures.
 - Use a ribbed roof or one with a standing metal seam to break up the surface.
 - Use metal with a matte, non-reflective finish.
 - Install the roof to have low profile seams.
 - Finish roof edges in a similar fashion to those seen traditionally.
- If repairing specialty roof materials such as glazed clay tile or barrel shingle, use a matching replacement material.
 - Consider using cement tiles when replacing clay tile roofs on larger buildings.
- If using shingles with embedded photo voltaic systems, use a dark color.

Inappropriate

- Do not use rolled roofing material except on flat roofs.

2.33 Minimize the visual impacts of skylights and other roof top devices.

Appropriate

- Locate skylights below the ridge line of the roof (a skylight that is flush with the roof plane may be considered where it remains visually subordinate).

Inappropriate

- Do not interrupt the plane of the historic roof with a skylight.

Architectural Details

Architectural details contribute to the character of a structure and some details are associated with specific architectural styles. Those details that are key character-defining features should be preserved. The method that requires the least intervention is preferred.

2.34 Preserve significant stylistic and architectural features.

Appropriate

- Retain and treat exterior stylistic features and examples of skilled craftsmanship with sensitivity.
- Preserve storefronts, cornices, turned columns, brackets, exposed rafter tails, jigsaw ornaments and other key architectural features.
- Employ preventive maintenance measures such as rust removal, caulking and repainting, that will protect historic details and their finishes.
- Minimize damage to historic architectural details when repairs are necessary.
- Document the location of a historic feature that must be removed and repaired so it may be repositioned accurately.
- Patch, piece-in, splice, consolidate or otherwise upgrade deteriorated features using recognized preservation methods.
- Stabilize or fix isolated areas of damage using consolidants. Epoxies and resins may be considered for wood repair.
- Protect significant features that are adjacent to the area being worked on.

Inappropriate

- Do not remove or alter distinctive architectural features that are in good condition and can be repaired. This includes cast iron storefronts, columns, windows, molding and trim, and cornices.

2.35 Preserve historic site features.

Appropriate

- Preserve carriage step blocks
- Preserve hitching posts
- Preserve wooden water towers and cisterns in rear yards



Storefronts, cornices, porches, turned columns, brackets, exposed rafter tails and jigsaw ornaments are examples of architectural features that should be preserved.



Employ preventive maintenance measures such as rust removal, caulking and repainting, that will protect historic details and their finishes.

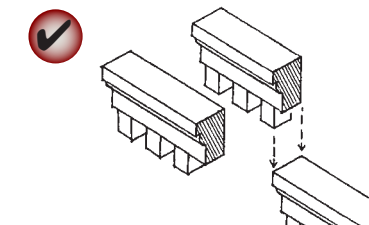

Patch, piece-in, splice, consolidate or otherwise upgrade existing materials, using recognized preservation methods.



Preserve historic site features such as carriage step blocks.

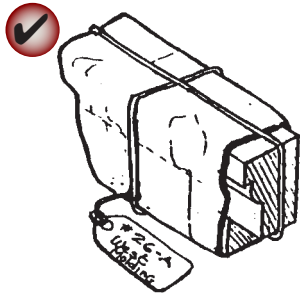

When removing a historic feature, document its location so it may be repositioned accurately.



Replace an architectural element accurately.



Decorative millwork should not be added to a building if it was not an original feature. Doing so would convey a false history. The illustrated details are inappropriate for this type of house.

2.36 Use technical procedures for cleaning, refinishing and repairing an architectural detail that will maintain the original finish.

Appropriate

- Use the gentlest means possible that will achieve the desired results.
- Employ treatments such as rust removal, caulking, limited paint removal and reapplication of paint or stain where appropriate.

2.37 If repair is impossible, replace an architectural feature accurately.

Appropriate

- Use a design that is substantiated by physical or pictorial evidence to avoid creating a misrepresentation of the building's history.
- Use the same kind of material as the original detail when feasible. However, an alternative material may be acceptable if the size, shape, texture and finish conveys the visual appearance of the original. Alternative materials are usually more acceptable in locations that are remote from view or direct contact.
- If reconstructing an architectural detail is impossible, design a compatible interpretation by using a new feature that is similar to comparable features in general size, shape, texture, material and finish. The replacement must match the original in material, composition, design, color, texture and other visual qualities.

Inappropriate

- Avoid adding architectural details that were not part of the original structure. For example, decorative millwork should not be added to a building if it was not an original feature. Doing so would convey a false history.

ADDITIONAL STANDARDS FOR HISTORIC BUILDINGS

A number of additional considerations are important to consider when working with historic resources, such as storm-safety, accessibility and the treatment of historic resources. The standards in this section apply to all projects involving work on a locally-designated individual historic landmark or a contributing structure in a locally-designated historic district. They do not apply to new construction in a locally-designated historic district.

Refer to “Preferred Sequence of Improvements” on page 28 for additional guidance on appropriate strategies.

Storm-Safety Features on Historic Buildings

In some cases it may be necessary or desirable to install storm-safety features such as hurricane shutters or removable window screens on a historic structure. Such features should be selected and installed to minimize visual impacts and damage to historic fabric.

Often, it will be most appropriate to install features that can be re-used such as removable storm screens, rather than relying on strategies that may require repeated, and damaging, installation, such as boarding windows with plywood.

2.38 Minimize the visual impact of hurricane shutters.

Appropriate

- Place impact-resistant hurricane shutters so as not to be substantially visible from the city right-of-way (preferred approach).
- Place hurricane shutters on a visible façade if they conform to the general design standards for shutters on page 39 (may be appropriate if consistent with the approach described in “Interpreting the Design Standards” on page 16).
- Ensure that the scale, durability and finish of hurricane shutters are substantially similar to historic wooden shutters of the architectural style and/or time period of the building.
- Ensure that the shutters fit the size of the window opening.
- Consider installing impact-resistant window films that are transparent and not visible from the street.
- Replace previously-installed Aramco storm protection with shutters, if possible.

Inappropriate

- Do not remove historic wooden shutters to install hurricane shutters.
- Do not damage historic window frames when installing hurricane shutters.



Administrative Approval of Hurricane Shutters

As summarized in “Administrative Approval” on page 16, installation of hurricane shutters that are in full compliance with the *Design Standards* may be administratively approved by the HPO or designated City staff.



Minimize the visual impacts of anchor bolts on the historic character of the building.

Administrative Approval of Flood Vents

As summarized in “Administrative Approval” on page 16, installation of flood vents may be administratively approved by the HPO or designated City staff if in full compliance with the *Design Standards*.

2.39 Minimize the visual impact of storm windows on historic buildings.

Appropriate

- When necessary, place storm windows internally to avoid visual impacts (preferred approach).
- If storm windows are installed externally, use window inserts designed to match the original frame (may be appropriate if consistent with the approach described in “Interpreting the Design Standards” on page 16).
- Paint existing storm window frames to match wooden frames. If the storm windows are aluminum, they should have a baked-on enamel color.

2.40 Minimize the visual impact of storm screens on historic buildings.

Appropriate

- When necessary, locate storm screens on windows that are not key features of the building.
- Minimize the visual impacts of anchor screws on the historic character of the building.
- Use anchor screws with plastic covers to reduce the possibility of rusting and deterioration.
- Place anchors on the inside of the window trim.
- Paint anchor screws the same color as the window trim.

Inappropriate

- Do not install storm screens with visible anchor bolts on the primary facade of a structure.
- Do not damage historic window trim or other building material when installing a storm screen.

2.41 Minimize the visual impact of flood vents on historic buildings.

Appropriate

- When it is necessary to install flood vents, ensure that significant architectural features are not altered.
- Use flood vents that do not exceed the minimum required size.

Inappropriate

- Do not place flood vents on the primary façade or other areas that are substantially visible from the public right-of-way.

Adaptive Reuse

Preserving rather than replacing a building can significantly reduce environmental impacts. Re-using a building preserves the energy and resources invested in its construction, and removes the need for producing new construction materials.

The best use for a historic structure is that for which the building was designed or a closely related one. Every effort should be made to provide a compatible use for the building, one that will require minimal alteration to the building and its site. An example of an appropriate adaptive use is converting a residence into a Bed and Breakfast. This can be accomplished without major alteration of the original building fabric.

It may be that in order to adapt a building to the proposed new use, such radical alteration to its significant elements would be required that the entire concept is inappropriate. In most cases, however, designs can be developed that respect the historic integrity of the building while also accommodating new functions.

2.42 Select uses that are compatible with the historic character of the building.

Appropriate

- When a significant change in use is necessary to keep a building in active service, select a use that requires the least alteration to significant elements.

Inappropriate

- Do not select a use that requires alteration of the structure's character-defining features.
- Do not select a use that adversely affects the historic integrity of the building.



Preserve, rather than replace a building.

Administrative Approval of Wheelchair Ramps

As summarized in “Administrative Approval” on page 16, installation of wheelchair ramps may be administratively approved by the HPO or designated City staff.

To be administratively approved, wheelchair ramps must:

- Comply with local zoning standards
- Comply with the *Design Standards for Historic Properties*
- Retain all historic materials that were removed to install the wheelchair ramp on site

City staff reserves the right to require Commission approval of all proposed wheelchair ramps.

Historic Additions

In some cases, a previously constructed addition may have taken on historic significance of its own. One constructed in a manner compatible with the original building and associated with the period of significance may merit preservation in its own right. These existing additions should be evaluated for potential re-use.

In contrast, more recent additions may detract from the character of the building and could be considered for modification or removal.

2.43 Preserve an older addition that has achieved historic significance in its own right.

Appropriate

- For example, a kitchen wing located on a residential building may have been added in its history. Such an addition is usually similar in character to the original building in terms of materials, finishes and design.

Accessibility

Where it applies, owners of historic properties should comply to the fullest extent possible with the Americans with Disabilities Act (ADA) and Texas Accessibility Standards (TAS) provisions, while also preserving the integrity of the character-defining features of their buildings and sites.

2.44 Design accessibility solutions to minimize impacts of the significant features of historic structures.

Appropriate

- Identify the historic building’s character-defining spaces, features and finishes so that accessibility code-required work will not result in their damage or loss.
- Provide barrier-free access that promotes independence for the disabled to the highest degree practicable, while preserving significant historic features.
- Locate lift systems at one end of a porch, where visual impacts will be minimized.
- Screen lift systems that are visible from the public right-of-way and paint screens to match the historic porch and structure.

Inappropriate

- Do not install accessibility solutions that do not minimize impacts on historic character or that alter key historic features.

Communications Equipment

Communications equipment includes antennae, satellite dishes, telecommunication dishes and cell phone equipment. Most such equipment has diminished greatly in size in recent years. The placement of communications equipment in a historic district requires prior approval by the Landmark Commission, if the equipment will be visible from the public right-of-way.

2.45 Minimize the visual impacts of communications equipment.

Appropriate

- Position communications equipment to be hidden or minimally-visible from public streets (including both streets on corner lots).
- Remove communications equipment that is no longer functional.
- Combine multiple antennae into one array wherever possible.
- Install satellite and telecommunications dishes that are minimal in size.

Inappropriate

- Do not damage exterior woodwork or trim detail during installation of communications equipment.
- Do not print or affix advertising on communications equipment, including satellite dishes.

FCC Regulations



The Federal Communications Commission (FCC) does not allow a local historic commission to deny the installation of most communications equipment. However, a commission may regulate the placement of such equipment on a structure.

If proper reception can be obtained, the Landmark Commission requires that communications equipment be installed in one of the following locations:

- On the rear wall or the rear half of the side walls
- Behind a chimney

If reception is not possible in one of the above locations, the Commission will evaluate alternatives.



Locate utility and mechanical equipment out of public view.

Utility Equipment

Utility equipment includes junction boxes, external fire connections, telecommunication devices, cables, conduits, HVAC equipment and other devices. When installed on historic properties, utility equipment should be visually unobtrusive and integrated into the design of the site and building.

2.46 Minimize the visual impacts of utility equipment on the public way and the surrounding neighborhood.

Appropriate

- Screen equipment from view.
- Use low-profile or recessed mechanical units on rooftops.
- Locate utility and mechanical equipment out of public view.

Inappropriate

- Avoid locating equipment on a primary facade
- Do not damage character defining features of historic structures when installing utility equipment.

2.47 Minimize the visual impacts of utility lines, junction boxes and similar equipment.

Appropriate

- Locate utility lines and junction boxes on secondary walls and group them, when feasible.
- Group lines in one conduit, when feasible.
- Paint these elements, to match the existing background color, when feasible.
- Locate utility pedestals (ground mounted) to the rear of building.

SUSTAINABILITY STANDARDS FOR HISTORIC PROPERTIES

Objectives for historic preservation and community sustainability are often in alignment. This section provides solutions for maintaining and improving resource and energy efficiency in a historic building, as well as methods for approaching energy conservation and generation technologies. Other sustainability standards throughout this document will also apply.

Planning a Rehabilitation Project for Energy Efficiency

Follow these basic steps when considering a rehabilitation project for energy efficiency:

STEP 1:

ESTABLISH PROJECT GOALS.

Develop an overall strategy and project goals to maximize the effectiveness of a project. Developing overall project goals will establish a broad view that can help place individual actions into context. Project goals should focus on minimizing use of resources and energy, minimizing negative environmental impacts, and retaining the historic integrity of a property. Strategies should maximize the inherent value of the historic resource prior to considering alterations or energy generation technology.

To inform a project strategy, conduct an energy audit. Energy audits can give a comprehensive view of how energy is currently used, in the daily and seasonal cycles of use, and can also provide perspective on the payback of investment for potential work on the building. For example, an energy audit, when examined based on an overall strategy, may demonstrate that priorities should be on increasing insulation in walls, ceilings and foundations, rather than replacing windows.



Galveston Historical Foundation's Green Revival House demonstrates compatible energy-efficiency retrofits to a historic residential structure.

Energy Efficiency Strategy

Follow these basic steps when considering alterations for energy efficiency:

Step 1. First, do an energy audit.

Step 2. Always maintain building components in sound condition.

Step 3. Then, maximize inherent sustainable qualities.

Step 4. Next, design landscapes to conserve resources.

Step 5. Finally, add new technologies sensitively.

Sustainable Site Design

Improvements to enhance energy efficiency and energy generation should preserve the historic integrity of the property and complement the original building, its site and its context.

Building Orientation. It is important to understand the orientation of a property, and the implications for solar access and weather impacts prior to beginning an energy conservation or generation project.

Seasonal Design Strategies. Solar angles and predominant wind patterns shift throughout the year, affecting the desired climate control strategy. The desired amount of natural lighting and ventilation can be managed based on these seasonal differences and should be taken into consideration.

STEP 2:

MAINTAIN BUILDING COMPONENTS IN SOUND CONDITION.

Maintaining existing building fabric reduces negative environmental impacts. Re-using a building preserves the energy and resources invested in its construction, and removes the need for producing new construction materials. See page 53 for more information on the environmental benefits of historic preservation.

STEP 3:

MAXIMIZE INHERENT SUSTAINABLE QUALITIES.

Typically, historic buildings were built with resource and energy efficiency in mind. Construction methods focused on durability and maintenance, resulting in individual building features that can be repaired if damaged, thus minimizing the use of materials throughout the building's life cycle.

Buildings were also built to respond to local climate conditions, integrating passive and active strategies for year-round interior climate control, which increase energy efficiency. Passive strategies typically include building orientation and features such as roof overhangs and windows to provide both natural day lighting as well as management of solar heat gain. Active strategies typically include operable building features such as awnings and double-hung and transom windows.

Identify a building's inherent sustainable features and operating systems and maintain them in good operating condition. In some cases these features may be covered, damaged or missing; repair or restore them where necessary.

STEP 4:

ENHANCE BUILDING PERFORMANCE.

A historic building's inherent energy efficiency should be augmented using techniques which improve energy efficiency without negatively impacting historic building elements. Noninvasive strategies such as increased insulation, weatherization improvements and landscaping should be employed.

**STEP 5:
ADD ENERGY-GENERATING TECHNOLOGIES
SENSITIVELY.**

The flexibility of many historic structures allows for the respectful integration of energy efficient technologies. Energy-generating technologies are the most commonly known strategies. However, the efficiency of a historic structure will often be great enough that generation technologies aren't the most practical solutions. Utilize strategies to reduce energy consumption prior to undertaking an energy generation project.



This house uses operable shutters, a sun room and wind generator for energy efficiency.



This rain barrel is part of a resource conservation strategy.

Residential Building Energy Efficiency Diagram

This diagram summarizes the principal direction in the standards for a rehabilitation project for energy efficiency on a residential building. These measures can enhance energy efficiency while retaining the integrity of the historic structure.

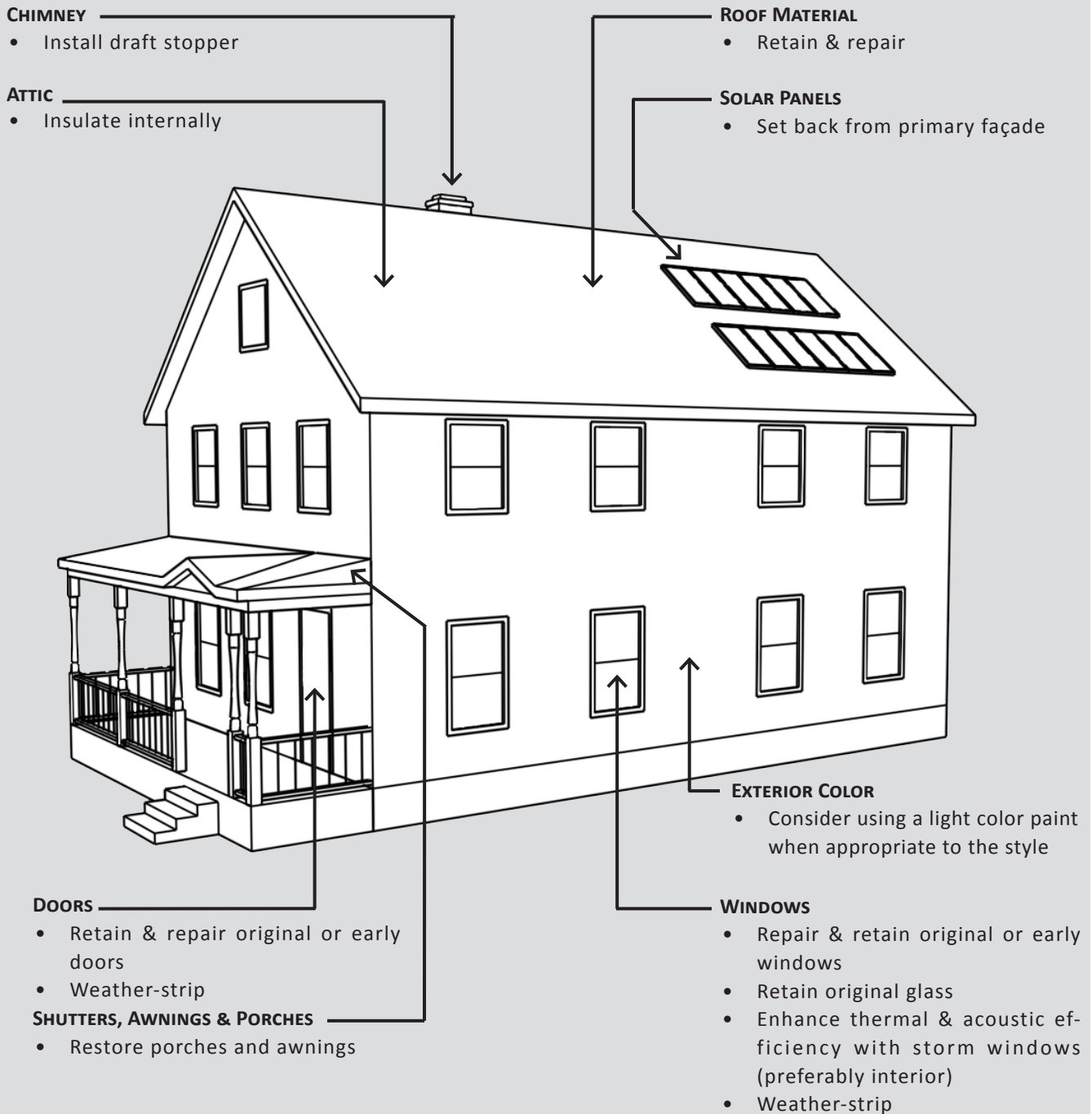

Commercial Building Energy Efficiency Diagram

This diagram summarizes the principal direction in the standards for a rehabilitation project for energy efficiency on a commercial building. These measures can enhance energy efficiency while retaining the integrity of the historic structure.

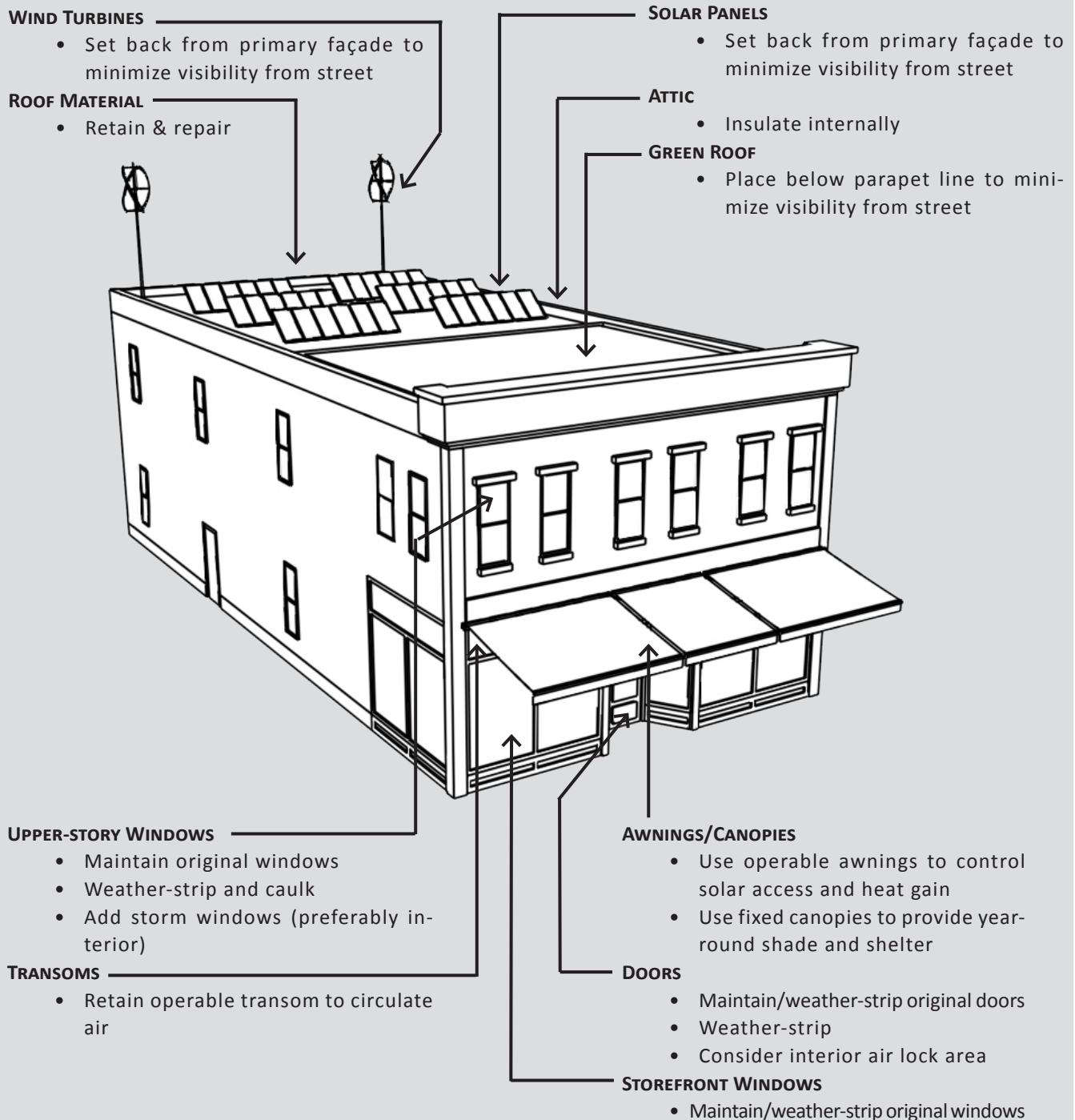

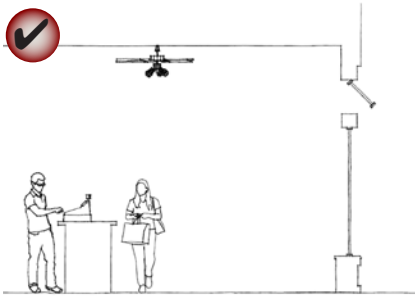

Operable features, such as transoms and ceiling fans, help regulate a building's temperature.

Maintaining the Inherent Energy Efficiency of a Historic Building

Original sustainable building features and systems should be maintained in good operating condition.

2.48 Preserve the inherent energy efficient features of the original building.

Appropriate

- Identify a building's inherent sustainable features and operating systems and maintain them in good condition.
- Repair or restore covered, damaged or missing features where appropriate.
- Retain and repair original roof material.

2.49 Maintain a building's sustainability features in operable condition.

Appropriate

- Retain original shutters, awnings, canopies and transoms. Operable features such as these will increase the range of conditions in which a building is comfortable without mechanical climate controls (see the standards for awnings on page 40 and canopies on page 111).
- Install draft stoppers in a chimney. Open chimney dampeners can increase energy costs by up to 30 percent.

Enhancing Energy Performance of Historic Structures

Improvements to enhance energy efficiency should complement the original building. The structure, form and materials should be sensitively improved in energy efficiency terms to preserve the building's character.

2.50 Use noninvasive strategies when applying weatherization improvements.

Appropriate

- Weather-stripping, insulation and storm windows are energy efficient, cost effective, and historically sensitive approaches.
- Weather-strip original framework on windows and doors.
- Install additional insulation in an attic, basement or crawl space as a simple method to make a significant difference in a building's energy efficiency. Provide sufficient ventilation to avoid moisture build-up in the wall cavity.
- Install weatherization strategies in a way that avoids altering or damaging significant materials and their finishes.
- Use materials which are environmentally friendly and that will not interact negatively with historic building materials.
- When a roof must be replaced, consider installing a radiant barrier."

Double-Hung Window Ventilation

Double-hung windows allow for two-way ventilation with cool air flowing in and warm air flowing out.

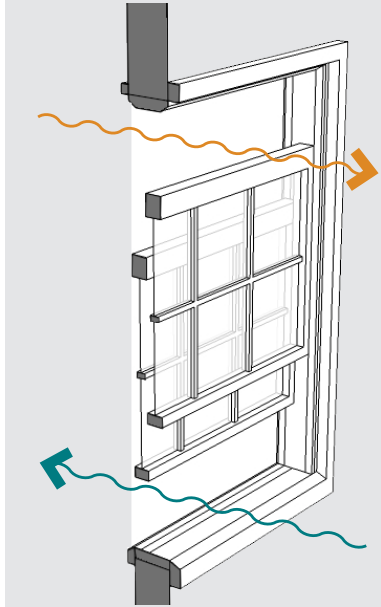



Plant trees and shrubbery to serve as windbreaks and provide seasonal shading.

2.51 Enhance the energy efficiency of original windows and doors.

Appropriate

- Make best use of original windows; keep them in good repair and seal all leaks.
- Retain early glass, taking special care in putty replacement.
- Maintain the glazing compound regularly. Remove old putty with care.
- Use operable systems such as storm windows, insulated coverings, curtains and awnings to enhance performance of original windows.
- Weather strip and caulk original framework.
- Double pane glazing may be acceptable where original glazing has been lost and the frame can support the weight and profile (note that storm windows may also be considered as described in “Storm-Safety Features on Historic Buildings” on page 47).

2.52 Design site and landscape improvements to promote energy efficiency.

Appropriate

- Use drought tolerant plants to reduce the need for irrigation.
- Plant trees and shrubbery to serve as windbreaks and provide seasonal shading.

2.53 Avoid adverse impacts to a historic building when installing a green roof.

Appropriate

- A green roof provides thermal mass to help regulate internal temperature, as well as helps to reduce the urban heat island effect.
- Green roof material should not replace significant roofing materials.
- The weight of the green roof should not threaten the structural integrity of the building. If additional structural support is needed, it should avoid adverse impact to the building’s historic significance.

Using Energy-Generating Technologies

When integrating modern energy technology into a historic structure, maintain the resource's historic integrity and the ability to interpret its historic significance. Use of energy-generating technologies should be the final option considered in an efficiency rehabilitation project. Utilize strategies to reduce energy consumption prior to undertaking an energy generation project. Consider the overall project goals and energy strategies when determining if a specific technology is appropriate for your project.

As new technologies are tried and tested, it is important that they leave no permanent negative impacts to historic structures. The reversibility of their application will be a key consideration when determining appropriateness.

2.54 Locate energy-generating technology to minimize impacts to the historic character of the site and structure.

Appropriate

- Locate technology where it will not damage, obscure or cause removal of significant features or materials.
- Maintain the ability to interpret the historic character of the building.

2.55 Install new technology in a reversible manner.

Appropriate

- Install technology in such a way that it can be readily removed and the original character easily restored.
- Use materials which are environmentally friendly and that will not interact negatively with historic building materials.

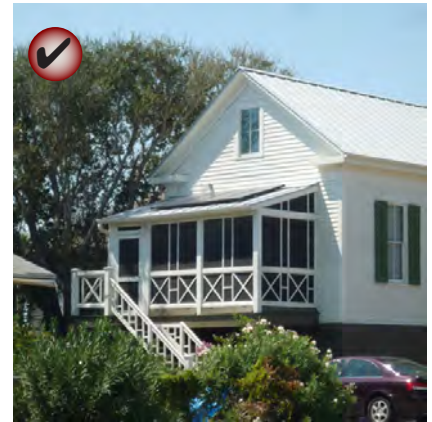

Solar collectors should be designed, sized and located to minimize their effect on the character of a historic building.

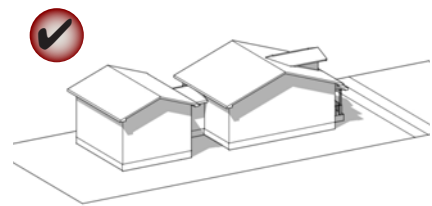

Locate an addition to maximize the potential for natural day lighting and solar energy collection. In this example, the addition is massed to take advantage of southern sun on the rear wall and rear-facing roof plane while also maintaining solar access to the primary structure.

Locating Energy Generating Technologies on a Historic Property

When locating energy generating technology on a historic property, it is important to minimize visibility from the street and impacts on historic building fabric.

As illustrated below, the ideal location for wind turbines and solar panels is in an unobtrusive location on the property. Appropriate locations for solar panel installation on a historic structure are illustrated on the next page.

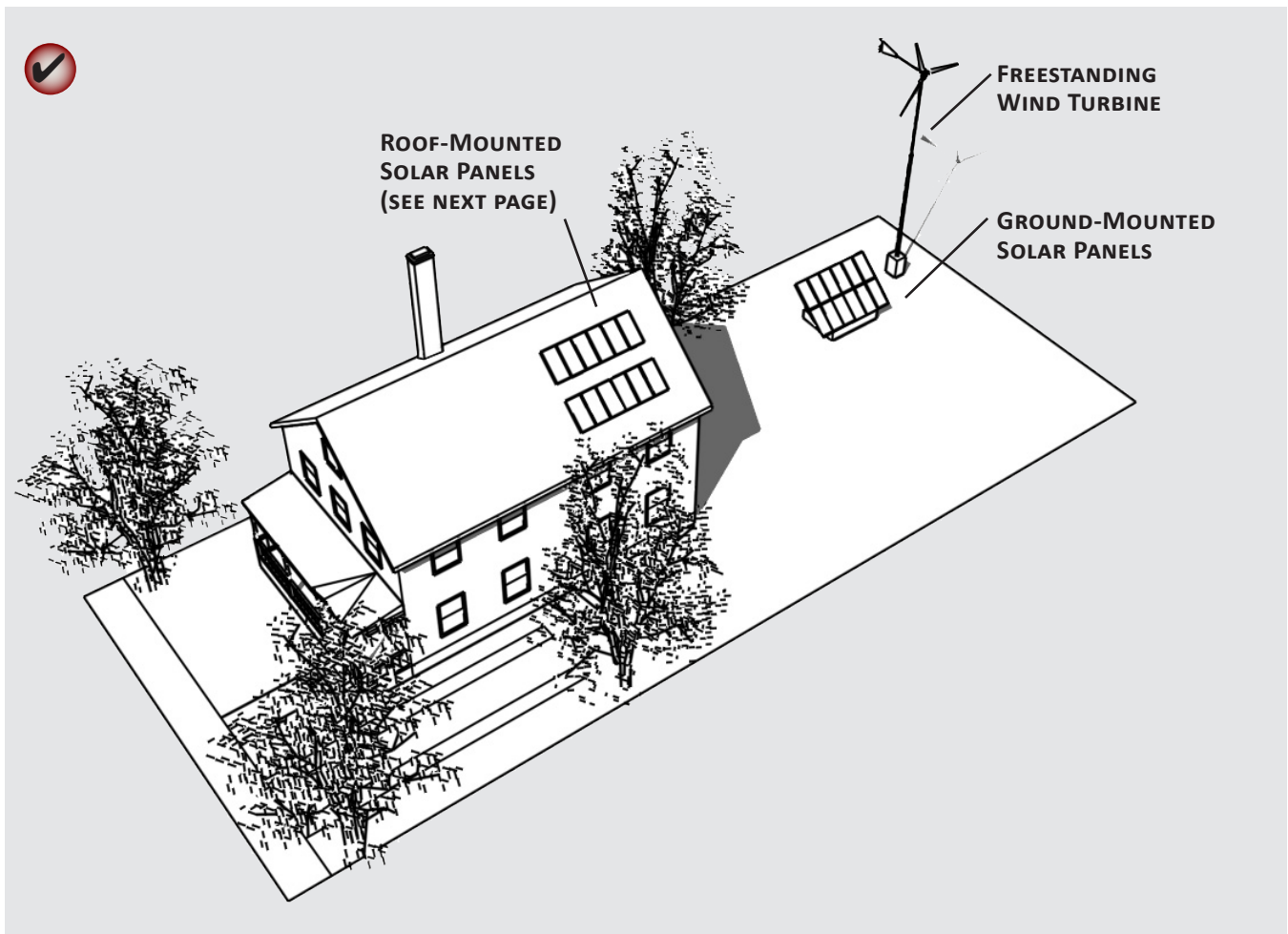

Locating Solar Panels on a Historic Structure

When locating solar panels on a historic building, it is important to consider the building's significance as well as the visibility of the proposed installation location.

An illustrated evaluation of appropriate solar panel installation locations on a sample residential structure is provided below.

Existing Structure

The two-story structure illustrated at right has a significant south-facing sloped roof area.



- Gable roof end faces the street
- Side of roof faces south

Preferred Location

If the existing structure has a high level of historic significance, the surrounding context has many intact historic structures or the roof is highly visible, panels should be set back from the front façade and flush-mounted to the roof.



- Panels are set back from the front façade.
- Panels are flush with the roof.

Acceptable Location

If the roof is not highly visible and/or site constraints restrict solar access, it may be appropriate to locate flush-mounted solar panels towards the front façade

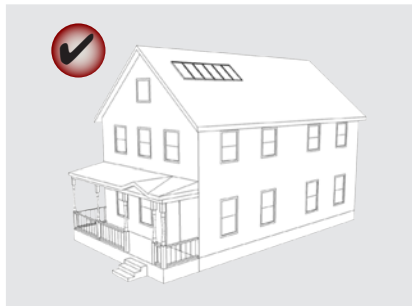

- Panels are set back from the eave, but closer to the front.
- Panels are flush with the roof.
- Panels are subordinate to the roof plane.



Minimize adverse effects from solar collectors on the character of a historic building.

SOLAR COLLECTORS

Solar collectors should be designed, sized and located to minimize their effect on the character of a historic building.

2.56 Minimize adverse effects from solar collectors on the character of a historic building.

Appropriate

- Place collectors to avoid obscuring significant features or adversely affecting the perception of the overall character of the property.
- Size collector arrays to remain subordinate to the historic structure.
- Mount collectors flush below the ridge line on a sloping roof. This will not cause a significant decrease in the device’s solar gain capabilities.
- Install collectors on an addition or secondary structure.
- Minimize visual impacts by locating collectors back from the front façade.
- Ensure that exposed hardware, frames and piping have a matte finish, and are consistent with the color scheme of the primary structure.

2.57 Use the least invasive method feasible to attach solar collectors to a historic roof.

Appropriate

- Avoid damage to significant features.
- Install a collector in such a way that it can be removed and the original character easily restored.

Inappropriate

- Do not threaten the structural integrity of the building with collector arrays.

2.58 Consider using building-integrated photo voltaic technology where the use of new building material is appropriate.

Appropriate

- Plan installation of integrated photo voltaic systems so they will not hinder the ability to interpret the historic significance of the structure. For example, installation of solar shingles on a rear or secondary roof façade where the original roof material is missing or significantly damaged would be appropriate.

WIND POWER

Small-scale wind generators can provide supplementary energy supply in some areas. The siting of turbines should take advantage of screening provided by vegetation and mature tree cover as well as existing buildings. Minimizing impacts to the historic character of a building as well as to adjacent properties should be the primary consideration.

Note that all wind power equipment must meet zoning requirements.

2.59 Minimize the visual impacts of a wind turbine from public view.

Appropriate

- Use turbines and any exposed hardware with a matte finish that is consistent with the color scheme of the primary structure.
- Do not obscure significant features or impair interpretation of the building's historic significance.

2.60 Install turbines to be readily removed.

Appropriate

- Attach turbines in a manner that avoids damage to significant features.
- Install turbines to allow restoration of affected building areas.

2.61 Minimize structural impacts when installing turbines.

Appropriate

- Install turbines as freestanding structures in unobtrusive locations when feasible.

Inappropriate

- Do not overload structural or roof protection systems when attaching turbines.



The waterfront near Downtown Galveston

CHAPTER 3

DESIGN STANDARDS FOR RESIDENTIAL PROPERTIES

Galveston includes a diverse range of historic residential properties and districts. The traditional character-defining features of such districts should be preserved. It is also important for new construction in historic residential districts to reinforce preservation objectives.

This chapter builds on the general preservation standards presented in Chapter 2 with specific design standards for residential properties including:

- Rehabilitation, alteration and expansion of locally-designated individual historic residential landmarks including houses and multi-family buildings
- Rehabilitation, alteration and expansion of contributing residential structures in locally-designated historic districts, including houses and multi-family buildings
- New residential construction or additions in any locally-designated historic district

Following a general description of Galveston’s residential development patterns, the standards in this chapter are organized into a general section applicable to all residential projects, including both historic rehabilitation and new construction, and a section that applies only to new residential construction and additions in locally-designated historic districts.



In This Chapter

Residential Development Patterns	68
Design Standards for All Residential Properties	71
Residential Site Standards	71
Residential Building Standards	76
Standards for Elevated Residential Foundations	80
Standards for Residential to Commercial Conversion.....	84
Design Standards for Residential New Construction and Additions	85
Site Standards for New Residential Construction	86
Massing Standards for New Residential Construction	88
Building Standards for New Residential Construction	92
Standards for New Secondary Buildings on Residential Properties	95
Standards for Residential Additions.....	96

RESIDENTIAL DEVELOPMENT PATTERNS

Galveston is home to one of the largest and most intact collections of late 19th and early 20th century buildings in the country. The original 1840 plat map acknowledged that land always would be limited because Galveston is on a barrier island. Streets were wide, but blocks were divided into fourteen long, narrow lots. This meant that as many as seven houses could be built close together on each side of a street. There was a mixture of building sizes, with big houses placed next to little houses. Front yards were small because it was necessary to locate out buildings, such as privies, stables, and alley houses, in the rear yards.



The climate of the Gulf Coast and the natural land features of Galveston Island also influenced the appearance of the neighborhoods. Flooding was even more of a threat in the 19th century than it is today. Bayous or marshy lands ran throughout the east end of the island and the seawall had not been built. As a result, buildings were raised — it was not practical to place them either on or close to the ground.



Many houses in Galveston are built relatively close together.

Most buildings were built of wood, which was readily available from Texas and other Gulf Coast forests. Brick and sometimes stone were used, occasionally for larger residences, but more frequently for commercial and institutional buildings in the downtown area.

The pattern of the neighborhoods and the visual appearance of the city were well established by the 1890s. The commercial core and the greatest concentration of large residences were located north of Broadway Boulevard on the Galveston Bay side of the island. There was a predominance of smaller house types on the south side of Broadway Boulevard.

The hurricane of September 8, 1900, caused destruction and heavy damage throughout the city, although the majority of structures north of Avenue P survived. When rebuilding, Galvestonians respected their city as it had developed during the 19th century. They maintained the long, narrow lots, and repeated, in later house types, the one-to-two story raised, frame structures.

Traditional Street Patterns

In a typical Galveston residential block buildings are placed close together; long, narrow lots; small front yards; sidewalk line is defined; each building is set back from the street about the same distance as illustrated below.

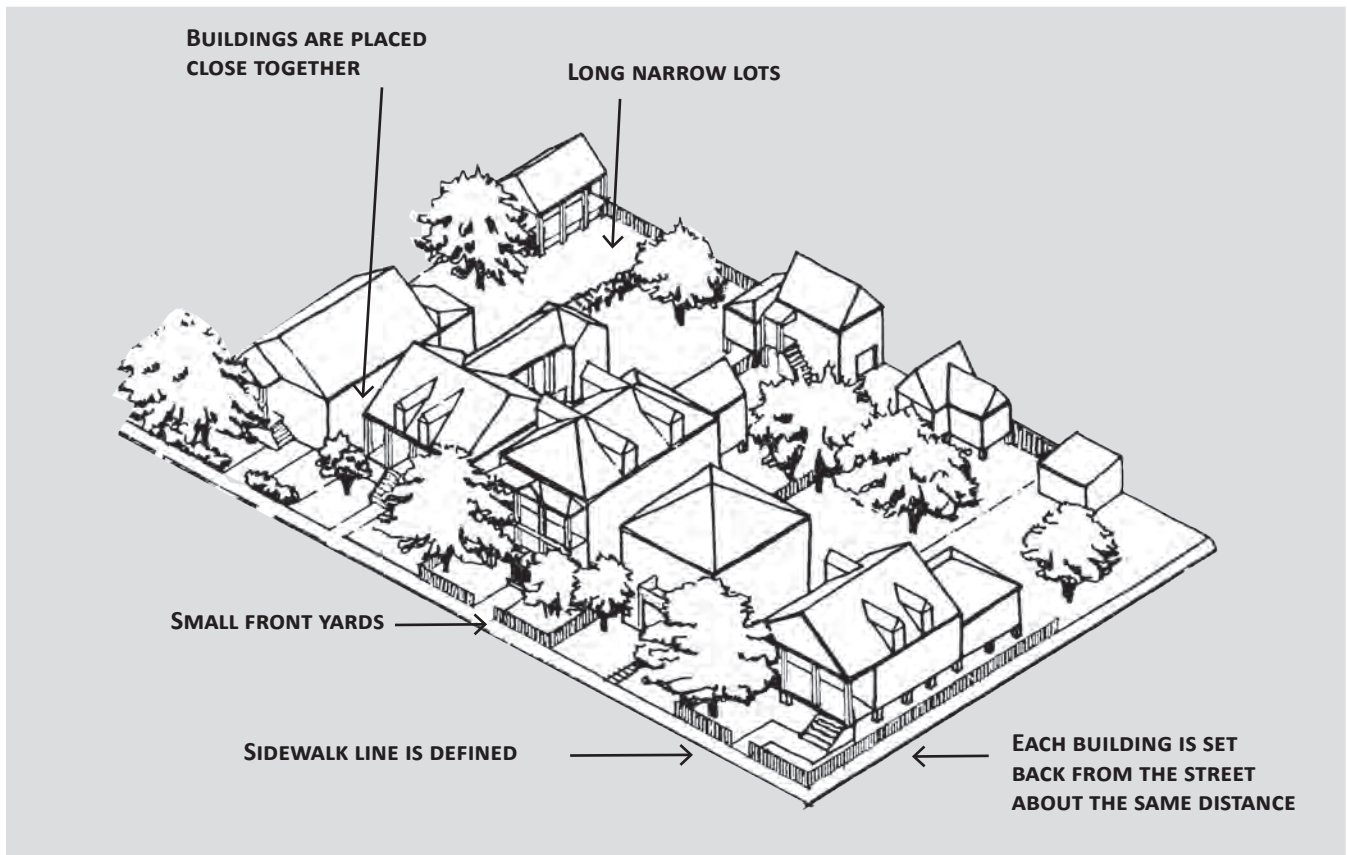

Traditional House Features

Big or little, fancy or plain, buildings in the older neighborhoods share many of the same basic features. The repetition of these features also contributes to the pattern of the neighborhoods. As illustrated below, the structures might vary in shape, but are similar in size.

A great variety of building types and styles appear in the older neighborhoods in Galveston. It is this variety that gives the city its remarkable architectural richness. Individually, each of these buildings contributes to the street; collectively, they give a unique quality to the city.

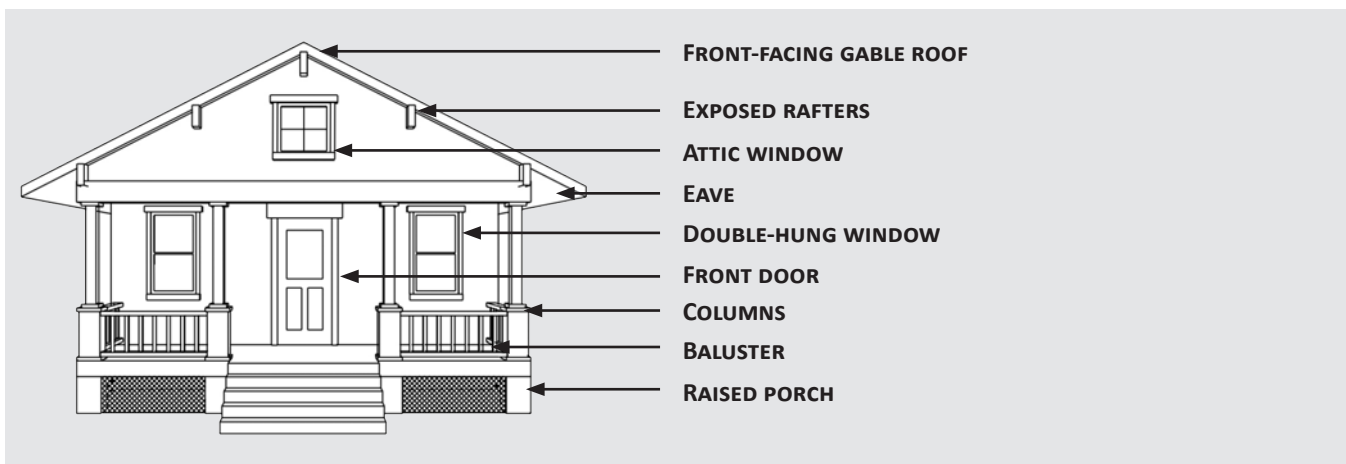
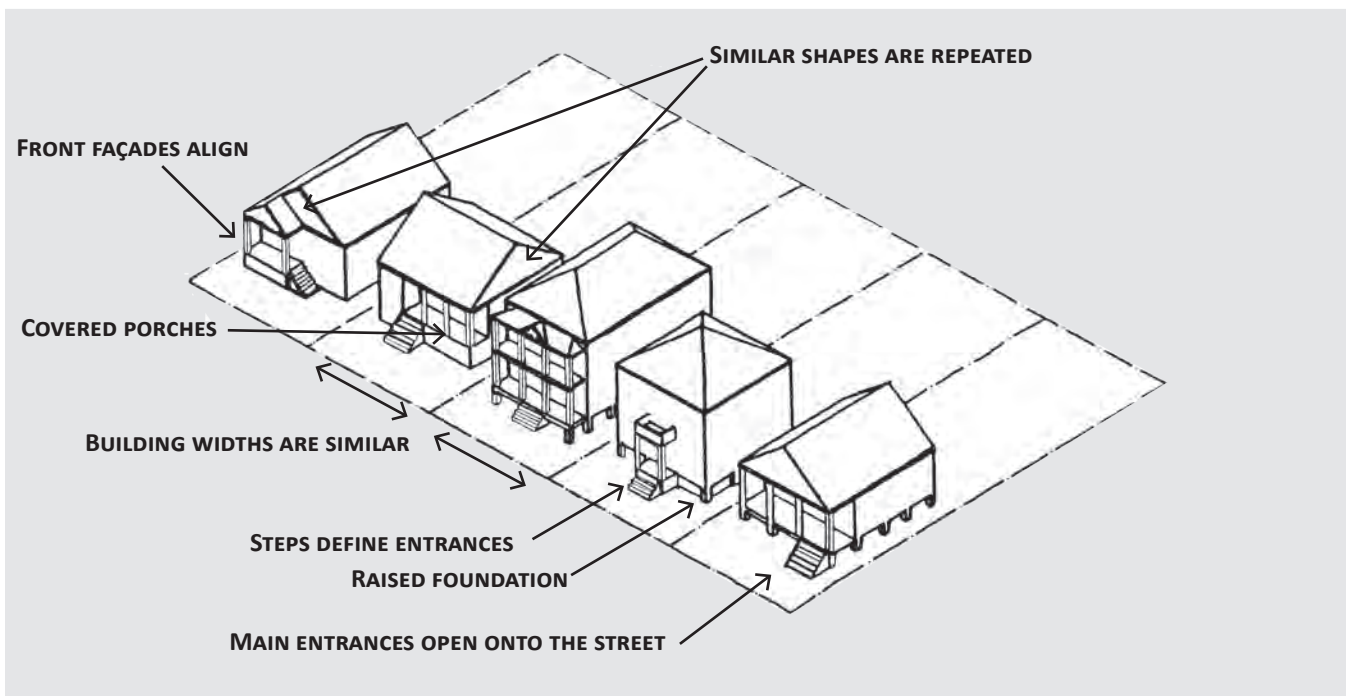

DESIGN STANDARDS FOR ALL RESIDENTIAL PROPERTIES

Maintaining the compatibility of historic residential sites and buildings is an important objective. The standards in this section apply to all residential projects. This includes work on a locally-designated individual historic residential landmark and work on a contributing historic structure or new construction in a locally-designated historic district. Note that standards for specific “historic” considerations such as the treatment of historic porches, do not apply to new construction or additions.

Residential Site Standards

The site layout of individual residential properties is an important characteristic of Galveston’s historic residential areas. Important site considerations include walkways, yards, fences, parking and planting.

SIDEWALKS AND WALKWAYS

Historically, a variety of paving materials on Galveston’s residential properties. Paths or walkways were gravel or oyster shell. Brick, unglazed tiles, slate, concrete, and packed earth were also used.

Sidewalks placed in City right-of-way must adhere to City Code requirements, with proper permits obtained from the Department of Public Works.

3.1 Maintain a historic sidewalk.

Appropriate

- Maintain historic stamped sidewalk impressions. (These are the names of the contractors that installed the sidewalk)

3.2 Visually connect the street and building.

Appropriate

- Maintain or install a walkway leading directly from the sidewalk to the main building entry.

3.3 Install new sidewalks to be compatible with historic ones in the area.

Appropriate

- Maintain the existing width of neighboring sidewalks.
- Use traditional materials such as brick or concrete (oyster shells, unglazed tile, slate/stone, or loose gravel may be considered if they do not negatively affect accessibility and safety).

Inappropriate

- Pebble-surface concrete is not permitted.
- Asphalt is not permitted.

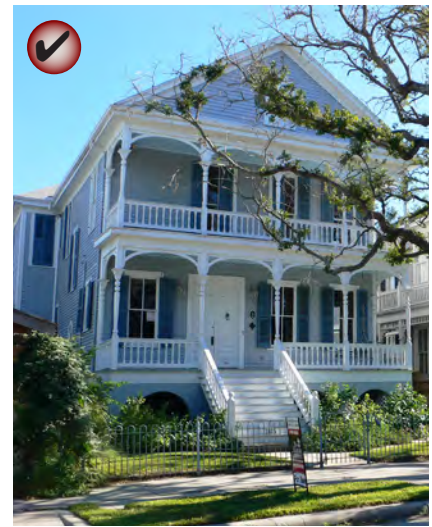

A walkway should lead straight from the sidewalk to the main building entry.

Administrative Approval of Fences



As summarized in “Administrative Approval” on page 16 and the table on page 17, installation of some fences may be administratively approved by the HPO or designated City staff.

A fence may be administratively approved if it:

- Is consistent with the style of the building
- Does not exceed 48”
- Surrounds a swimming pool and does not exceed 5’ or a height dictated by state and local law
- Is located behind historic privacy walls that exceed 5’ and is not substantially visible from the city right-of-way
- Is located on a corner yard, matches the front yard fencing and does not exceed 4’ in height

Additional flexibility exists for a non-corner side or rear yard fence. Such a fence may be administratively approved if it:

- Is solid cedar not exceeding 6’ in height with an additional 2’ of framed wooden lattice for a total height of up to 8’
- Is cast or wrought iron not exceeding 8’ in height

A fence that does not meet at least one of the above criteria must be reviewed by the Landmark Commission.

YARDS

The progression of public to private space on a property is an important characteristic in Galveston’s residential districts. A grassy front lawn, with accent planting and shade trees are essential features.

3.4 Provide a landscaped front yard.

- Reserve most of the front yard area for a grass lawn.
- Do not pave the front yard.
- Consider using decorative modular pavers, grass and cellular paving systems in order to minimize the impact of hard surface paving where grass or other plant materials are not used.

FENCES AND WALLS

Fences and low walls have defined Galveston front yards since the 19th century. Wood picket and cast-iron fences were the most common historic fence materials. Some more elaborate fences have an unusual combination of cast and wrought-iron materials. Low walls that followed the sidewalk line were masonry and frequently stuccoed brick. Front yards were not enclosed with high walls; these were confined to rear yard areas.

Fences may be placed on the property line, but may not extend into the City right-of-way, without a License to Use Agreement with the City.

3.5 Maintain historically significant fences and masonry site walls.

- Maintain historically significant wooden picket or cast iron fences.
- Maintain historically significant stuccoed brick or concrete masonry site walls.



Maintain historically significant cast iron fences and stuccoed brick or concrete masonry site walls.

3.6 Design a new fence to be compatible with the architectural style of the house and existing fences in the neighborhood.

Appropriate

- Install a painted wood picket fence (this is the preferred option in most historic residential areas, and is often the easiest to install).
- Install a simple wood-and-wire fence, provided that it is appropriate to the style of the house and does not exceed 48” in height.
- Install a cast-iron or other metal fence not exceeding 48” in height if located in the front yard.
- Install a fence that uses alternative materials that have a very similar look and feel to wood, proven durability, matte finish and an accurate scale and proportion of components. See “Using Alternative Materials on a Historic Structure” on page 31 and the table on page 17 for more information (may be appropriate if consistent with the approach described in “Interpreting the Design Standards” on page 16).

Appropriate for a Non-Corner Side or Rear Yard Fence

- Install a fence that uses alternative materials with proven durability, matte finish and an accurate scale and proportion of components.
- Install a simple wood-and-wire fence, provided that it is appropriate to the style of the house (may exceed 48” in height if compatible).

Inappropriate

- Do not install chain link fencing.
- Do not mix wooden and metal fence styles.
- Do not use heavy brick fence posts unless there is historic documentation of their use.



A painted wood picket fence is the preferred option for fencing in most historic residential areas. Alternating, scalloped and variegated styles are seen on a number of historic properties in Galveston.



A simple wire fence is appropriate for use with some historic architectural styles.



Wrought iron or other metal fences are appropriate when compatible with the building.



Metal loop and spear style fences are seen on a number of Galveston’s historic properties.

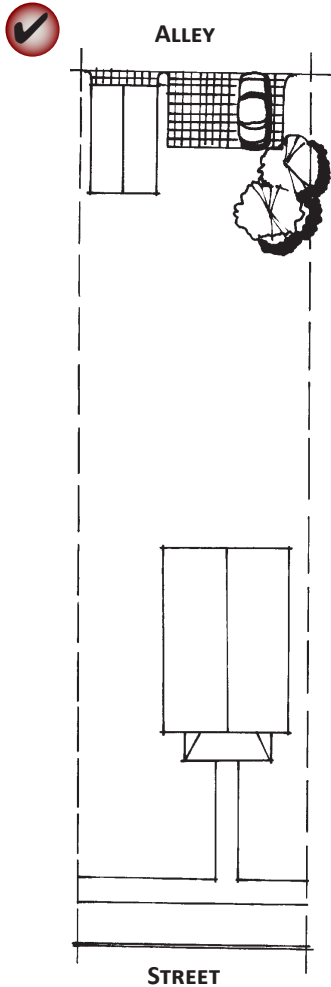

Locate a parking area to the rear of a site.

PARKING AND DRIVEWAYS

Driveways placed in the city right-of-way must adhere to the requirements for sidewalks as prescribed by the City Code. The proper permits must also be obtained.

3.7 Minimize the visual impact of parking.

Appropriate

- Locate a parking area at the rear or to the side of a site whenever possible.
- Use landscaping to screen parking areas.
- Keep paved areas and curbs cuts for driveways to a minimum widths.
- Maintain historic strip driveways. These driveways, from the 1920s and 1930s, allow for better drainage and permit grass to grow between the concrete strips.

Inappropriate

- Paving the front yard for parking is not permitted.
- New driveways and garages that open onto a primary street are not permitted.
- A new semi-circular drive in a front yard is not permitted unless there is evidence of its previous existence.

PLANTING

When site development, such as parking, storage and equipment areas, creates an unavoidable negative visual impact on abutting properties or to the public way, it should be screened with landscaping that complements the existing natural character and context of the site.

Ordinarily, approval is not needed from the Landmark Commission for planting materials. Approval must be obtained from the City if the work involves removing trees or shrubs from the City’s right-of-way. Removal of existing trees is discouraged.

3.8 Use plant materials to screen utility installations, and service and parking areas.

Appropriate

- Shrubs and trees that branch close to the ground are most effective.
- Keep trees and shrubs trimmed, both as a security precaution and to minimize storm damage.
- Use a flowering vine to cover an existing chain-link fence.
- Use landscaping to complement your building and its features.
- Keep landscaping simple and easy to maintain.

LIGHTING

Site and building lighting are important considerations for both historic buildings and new construction.

Lighting installation must adhere to City Code requirements. In addition, the Landmark Commission must approve the removal or addition of exterior light fixtures. The description, product data sheet, or sample light fixture should be submitted to the Commission for review.

3.9 Preserve and maintain original fixtures.

Appropriate

- Historic fixtures can be reconditioned and rewired.

3.10 Design lighting that is in character with the setting.

Appropriate

- Fixtures should be compatible with architectural and site design elements.
- Employ new fixtures that are modest in character.
- Mount new light fixtures on porch ceilings or adjacent to entrances.
- Inset ceiling lights that spread a soft light over a porch entrance are permitted.
- Mount a light fixture such that it will not interfere with the opening and closing of shutters or doors.
- Security lighting, such as flood lights, should be mounted on rear or side of a structure rather than on the front.
- Use incandescent lighting or sources that appear similar in character. Fluorescent and LED sources may be used when the color is similar and incandescent.

Inappropriate

- Avoid historic-looking new fixtures because they may convey a sense of false history.
- Do not use light sources that create a harsh glare or a color that is not similar to that of incandescent light.



Maintain and repair the original size and shape of dormers.

Typical Residential Roof Forms in Galveston

GABLE ROOF

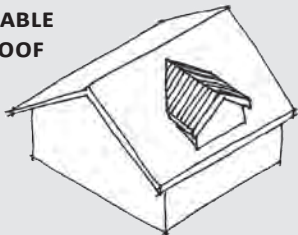

HIP ROOF

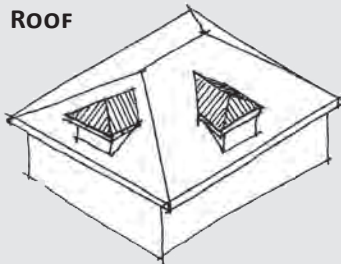

Typical historic residential roof forms in Galveston include hipped and gable-end roofs. Some traditional residential structures may feature both types of roof.

Residential Building Standards

HISTORIC RESIDENTIAL ROOFS

Most roofs on older residential buildings have one of the following shapes: gable, hipped, pyramidal or a combination of a gable and hipped roof. Typical 19th and early 20th century roofing materials were slate, metal, wood shingles, asbestos tiles or composition materials.

When replacing a roof, select a material and a pattern that is historically appropriate to the house. If documentation of the original roof exists or an early roof on the house, use a comparable roofing material, similar in size, shape, texture, and color. If documentation is not available, precedents on similar buildings may be considered. Look at the roofing on building types that are similar to your house.

See “Historic Roofs” on page 43 for additional information.

3.11 Preserve the original roof form of a historic residential structure.

Appropriate

- Maintain and repair the original size and shape of dormers.
- Avoid altering the angle of a historic roof.
- Installing a new dormer on a secondary roof plane may be considered when it will remain subordinate in scale and character to the roof itself. Proposals for new dormers on secondary façades require Landmark Commission approval.

Inappropriate

- Do not introduce new dormers on a visible street façade. Do not introduce skylights, vents or attic ventilators on street-facing roof slopes.
- New roofing systems that permanently damage or alter the existing historic roof are not permitted.

HISTORIC RESIDENTIAL WINDOWS

Windows in older Galveston buildings are important character-defining features. Most windows are wooden, double-hung sash. This means that they have two balanced sashes, one sliding over the other vertically. Each sash is divided into panes, also called “lights.”

Also see “Storm-Safety Features on Historic Buildings” on page 47.

3.12 When replacing a window, match the original design and pane configuration.

Appropriate

- Use wood frames and sashes for windows on a primary façade (preferred approach).
- Consider using clad wood windows on a primary façade (may be appropriate if consistent with the approach described in “Interpreting the Design Standards” on page 16).
- Maintain the wood window trim if metal or vinyl windows are installed (non primary façade only).
- Reinstall windows and doors in previously enclosed openings. City staff will field verify all evidence of the feature’s previous existence prior to approval.
- Use clear replacement panes.

Inappropriate

- Vinyl windows are not permitted on primary façades
- Tinted glass is not permitted.
- Do not change the size or position of a window opening.
- The addition of large picture windows on the main façade is not permitted.
- Do not use dark window screens.
- Do not use unpainted metal sashes with a raw metal color.

HISTORIC RESIDENTIAL GARAGE DOORS

3.13 Use a wooden garage door to match the historic architectural style where possible.

Appropriate

- Keep details simple on a replacement wooden door.
- Paint a wooden garage door to help maintain its condition.
- Consider replacing a garage door on the primary façade with a metal door that has an appropriate look and finish if a wood door can’t be found to meet storm-safety requirements.

Inappropriate

- Do not use a metal garage door on the primary façade of a building.

Administrative Approval of Windows



As summarized in “Administrative Approval” on page 16, changes in window and door openings on the rear and side elevations not substantially visible from the street right-of-way (not including alleys) may be administratively approved by the HPO or designated City staff.

Requests to install art or stained glass in windows will be considered on a case-by-case basis. See “Interpreting the Design Standards” on page 16 for more information.



Maintain an original porch or gallery on a house.

Administrative Approval of Porch Conversion

As summarized in “Administrative Approval” on page 16, the restoration of wooden porches and stairs that have been converted to concrete may be administratively approved by the HPO or designated City staff.

Administrative Approval of Porch Rail Reinstallation

As summarized in “Administrative Approval” on page 16, reinstallation of porch rails may be administratively approved by the HPO or designated City staff if evidence clearly support their previous existence. Staff will field verify all evidence of the feature’s previous existence prior to approval.

HISTORIC RESIDENTIAL PORCHES AND DECKS

Porches and galleries are, and always have been, the focal point of Galveston houses. They frame and protect the main entrances. They also display a concentration of decorative details. In many neighborhoods, they continue to serve as outdoor living rooms. Some very simple houses, including alley houses, have an uncovered porch or stoop at the entrance.

Most porches are built entirely of wood, in keeping with the frame house construction. There are some exceptions, such as Craftsman-style dwellings that have wooden tapered columns on top of masonry pedestals. A few early frame houses also have cast-iron balustrades that are original.

Preserving front porches is a high priority. Rear and side porches also may be important architectural features, especially for buildings that are located on corner lots, and their preservation is encouraged (although these may also be appropriate locations for new additions.)

Also see “Extending Porch Stairs to Access an Elevated Foundation” on page 82 for guidance on extending porch stairs to raised residential foundations.

3.14 Maintain an original porch or gallery on a house.

Appropriate

- Maintain the height and shape of the porch roof.
- Re-open an enclosed rear porch.
- Consider removing a non-historic rear access stair.

Inappropriate

- Do not enclose or screen a front porch.

3.15 If necessary, replace damaged porch elements.

Appropriate

- Use materials that are similar to the historic building materials.
- An alternative material may be considered for a porch in a secondary location, when the appearance is similar to that of the original. See “Using Alternative Materials on a Historic Structure” on page 31 for more information.

3.16 If necessary, replace damaged porch railings and steps.

Appropriate

- Use as much of the original materials and ornamentation as possible.
- Where necessary, replace original railing and step materials with alternative materials that have a similar texture and finish to the original materials.
- Re-install porch rails to match existing rails when appropriate. See the sidebar on “Administrative Approval of Porch Rail Reinstallation.”

Inappropriate

- Do not use cast-iron columns and railings where no evidence exists that they were used historically.
- Do not use brick bases for wood columns (exception is Craftsman styles).
- Do not use steel pipe columns.
- Do not use horizontal railings or railings that are too elaborate for the building (of a different style).
- Do not use concrete supports and/or steps.
- Do not relocate front stairs or steps.

Repair of Porch Railings

Avoid removing original materials that are in good condition or that can be repaired in place.



Before: A deteriorated railing should be repaired not replaced when feasible.



After: Railing has been repaired and the base of the post has been replaced in-kind.

Historic Building Elevations in Galveston



Originally, buildings in Galveston were raised on wood or masonry foundations that were as high as seven feet. The heights were reduced when the island was filled after the 1900 hurricane, and most early 20th Century homes were on much more moderately elevated foundations.

FEMA Standards Exceptions for Historic Buildings

Special provisions in FEMA insurance policies provide greater flexibility to historic structures, in terms of raising the floor level. For example, qualifying structures may be exempt from new flood plain codes that require that they be raised. Refer to Chapter 1, page 14 for additional information.

Standards for Elevated Residential Foundations

In some cases, it may be necessary or desirable to elevate the foundation of an existing or new residential structure to provide greater flood protection. Elevated residential foundations should be compatible with the surrounding historic context.

The standards below should guide both the raising of an existing or re-located residential structure, and the foundation elevation of new residential construction.

ELEVATING A RESIDENTIAL FOUNDATION

The Landmark Commission will consider requests to raise a structure to meet flood elevation requirements if the overall change in height is compatible with the building type and context.

3.17 Locate the foundation height of a structure to be compatible with the building type and surrounding historic context.

Appropriate:

- Ensure that the foundation height of an elevated structure is in scale with historic structures on the block face.
- Ensure that the foundation height is compatible with the character of the elevated structure.

Inappropriate:

- Do not raise a structure to install a street-facing garage door beneath the first floor.



Ensure that foundation height is compatible with the character of the elevated structure.

ENCLOSING AN ELEVATED FOUNDATION

To preserve the character of Galveston’s historic residential streets, elevated foundations should be enclosed or skirted in a way that promotes compatibility with surrounding residential structures. Note that it is also important to provide proper ventilation underneath a structure to discourage rot and mold. See “Storm-Safety Features on Historic Buildings” on page 47 for more information.

3.18 Enclose the space between the elevated foundation piers of a raised residential structure.

Appropriate for enclosing an elevated foundation (elevated to any compatible height):

- Properly dimensioned wood board and batten (see “Options for Board and Batten Foundation Skirting”).
- Masonry (note that masonry may not be appropriate for smaller wood-framed houses.)
- Stucco, when compatible with the building type (a stuccoed foundation enclosure will generally be most compatible with a bungalow-type building.)
- Lattice and masonry combinations

Appropriate for enclosing a low elevated foundation only (elevated approximately 18” or less):

- Plywood panels framed and placed behind the foundation piers, faced with an appropriate material such as lattice, then painted a dark color that blends with the structure.

Appropriate for enclosing a moderately elevated foundation only (elevated approximately 4’ or less):

- Wood-framed lattice

Inappropriate materials for the enclosure an elevated foundation:

- Cinder blocks
- Plastic or vinyl lattice
- Cedar shingles
- T-1-11 siding
- Plywood (except as used to skirt a low elevated foundation as described above)
- Cementious fiber board (except as used for board and batten skirting as described in “Options for Board and Batten Foundation Skirting”)
- Corrugated metal
- Faux siding (including faux brick and stucco)

Options for Board and Batten Foundation Skirting

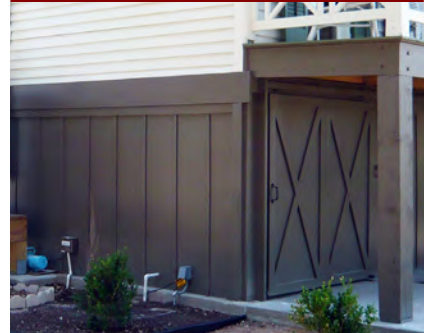

Board and batten is a type of exterior siding or interior paneling that has alternating wide boards and narrow wooden strips, called battens. It is an appropriate treatment for enclosing most elevated residential foundations in Galveston.

Board and batten should generally be composed of 2” wide battens applied 12” on center to cover seams between boards. It may be appropriate to substitute painted plywood boards with smooth cementious fiber board, painted to match the battens and be compatible with the elevated structure.

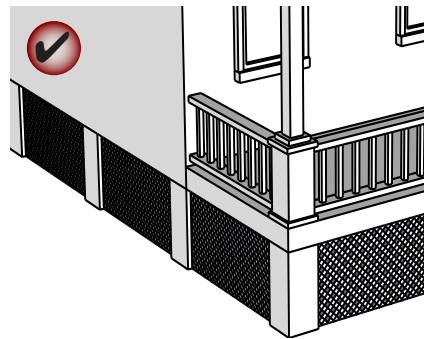

Framed lattice may be an appropriate foundation enclosure material for foundations elevated 4’ or less.



Stucco is often an appropriate foundation enclosure material.

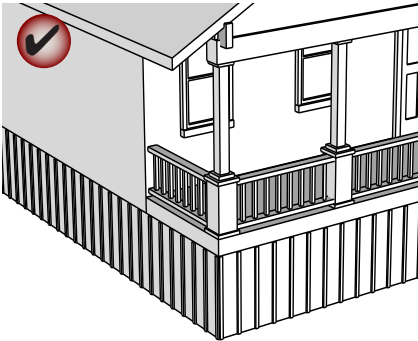

Properly dimensioned wood board and batten is an appropriate foundation enclosure material for foundations elevated over 4'.



A 90 degree dog-leg stair extension may be appropriate to access an elevated front porch.

EXTENDING PORCH STAIRS TO ACCESS AN ELEVATED FOUNDATION

In most cases, elevating a residential foundation will require porch stairs to be raised and/or extended. Extended porch stairs should be designed to be compatible with the design of the front porch and entry.

3.19 Extend stairs to be compatible with the design of the front entry and porch.

Appropriate:

- Extending front-facing porch stairs towards the street where space allows.
- Extending front-facing stairs with a 90-degree dog-leg extension to access an asymmetrical front porch.
- Extending front-facing stairs with two symmetrical 90-degree dog-leg extensions to access a symmetrical front porch.



Where space allows, it is appropriate to extend front-facing porch stairs directly towards the street.

Appropriate Enclosure and Porch Stair Extension for an Elevated Residential Foundation

Appropriate foundation enclosure and porch stair extension designs depend on the height of the elevated foundation and the configuration of the porch (whether the porch stairs extend from the middle of the porch in a symmetrical design or from the side in an asymmetrical design). Appropriate enclosure and porch stair extension strategies for different foundation heights are summarized below.

Low Elevated Foundations

Foundations elevated 18" or less may be enclosed with plywood panels framed and placed behind the foundation piers, faced with an appropriate material such as lattice, then painted a dark color that blends with the structure.

Front-facing porch stairs should generally be extended further forward if space permits.

Symmetrical Porch Design



Asymmetrical Porch Design



Moderately Elevated Foundations

Foundations elevated 4' or less may be enclosed with wood-framed lattice.

Front-facing porch stairs should generally be extended further forward if space permits.

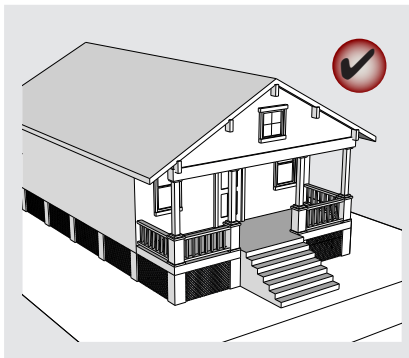

High Elevated Foundations

Foundations elevated more than 4' must be enclosed with properly dimensioned board and batten, stucco or masonry where appropriate.

Where the porch design is symmetrical as illustrated in the left column, symmetrical porch stair extensions are preferred.

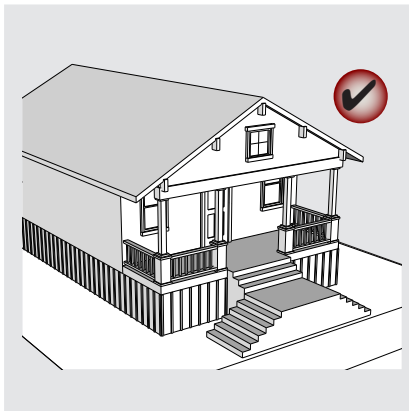



Maintain a residential structure’s character when converting to a commercial use.

Standards for Residential to Commercial Conversion

In the historical districts, there are buildings that were built as residences and are now used for commercial or mixed commercial and residential purposes. Sometimes a change of use or an added use is acceptable. The design standards for existing residential buildings also apply to residential structures that are used for commercial activities. See the City’s zoning code for guidelines pertaining to parking requirements. Bed and Breakfast establishments are regulated through Section 29-93 of the Galveston Zoning Standards and require a Specific Use Permit.

In general, the conversion of a residential building to commercial uses is discouraged. The predominant original character of the districts and the buildings is residential.

3.20 Maintain a residential structure’s character when converting to a commercial use.

Appropriate

- Ensure that a house continues to look like a house despite its change in use to commercial.

DESIGN STANDARDS FOR RESIDENTIAL NEW CONSTRUCTION AND ADDITIONS

This section presents design standards for the construction of new residential structures. They apply to the design of new infill in the residential historic districts of Galveston. These guidelines also apply when alterations are being considered for non-contributing properties in those contexts. These “infill” principles relate to the fundamental relationships of a building to its context—such as mass, scale and form. These same principles are the most important for other, non-historic houses.

Designing a building to fit within the historic character of a neighborhood requires careful thought. Preservation in a historic district context does not mean that the area must be “frozen” in time, but it does mean that, when new building occurs, it should occur in a manner that reinforces the basic visual characteristics of the district. This does not imply, however, that a new building must look old. In fact, imitating historic styles is generally discouraged.

Rather than imitating older buildings, a new design should relate to the fundamental characteristics of the historic houses on a block while also conveying the stylistic trends of today. It may do so by drawing upon basic ways of building that make up a part of the character of the property. Such features include the way in which a building is located on its site, the manner in which it relates to the street and its basic mass, form and materials. When these design variables are arranged in a new building to be similar to those seen traditionally, visual compatibility results.

These basic design relationships are more fundamental than the details of individual architectural styles and, therefore, it is possible to be compatible with the historic context while also producing a design that is contemporary.

See “Demolition Considerations” on page 14 for information on the demolition of existing primary and secondary structures to make way for new construction.

Considering Context



Compatibility with the context is a key principle for the design of new construction in a historic district. This typically focuses on buildings in the same block, on both sides of the street, and also across an alley, where that exists. Those buildings that are considered “contributors” to the district make up the context. In some cases, a non-contributing structure may also be found in the immediate vicinity, but this does not influence considerations of compatibility. Also note that, in some cases where substantial numbers of historic buildings may be lost, perhaps by natural disaster, then a broader geographic area may be used to consider as context.



Locate a new building to fit within the range of setback dimensions seen in the block.

Site Standards for New Residential Construction

New residential construction in locally-designated historic districts should be sited and oriented to be compatible with surrounding neighborhood patterns as described on page 68. The below site standards for new construction apply in addition to the general residential site standards on page 71.

3.21 Locate a new structure to fit within the range of front yard setbacks on the block.

Appropriate

- Where front yard setbacks are uniform, place a new structure in general alignment with its neighbors.
- Where front yard setbacks vary, place a new structure within the established range of front yard setbacks on the block.

Inappropriate

- Do not locate a structure outside the range established range of front yard setbacks.

3.22 Maintain the side yard spacing pattern on the block.

- Locate a structure to preserve the side yard spacing pattern on the block as seen from the street.

3.23 Orient the front of a house to the street and clearly identify the front door.

Appropriate

- Design the front entrance to be clearly identifiable.
- Use a porch to define the entry.

Appropriate Front Yard Setbacks

The placement of a new structure should be compatible with the pattern of front yard setbacks along the block as illustrated below.

Consistent Setback Context

On some blocks, front façades are in general alignment, and front yards have a consistent depth. In this context, a new structure should be built at the same front yard setback as the existing structures on the block as illustrated at right.

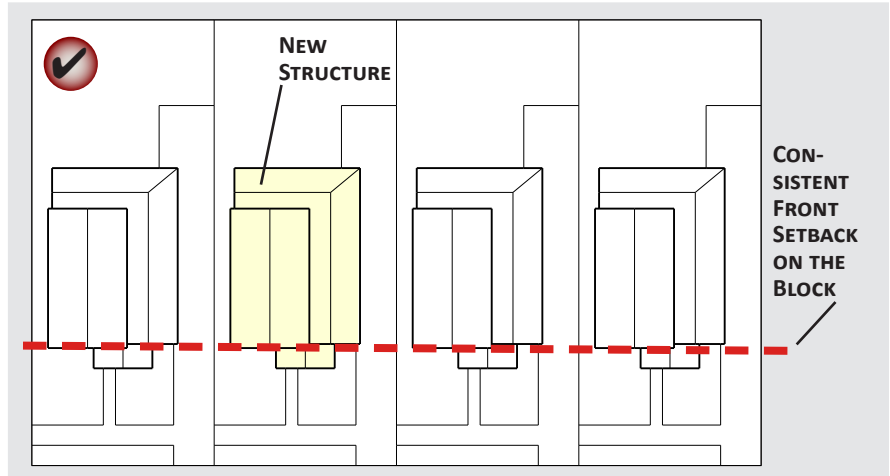

Varied Setback Context

On some blocks, the historic front yard setback pattern is varied, and additional flexibility is appropriate in the placement of a new structure. In this context, a new structure should be built within the established range of front yard setbacks on the block as illustrated at right.

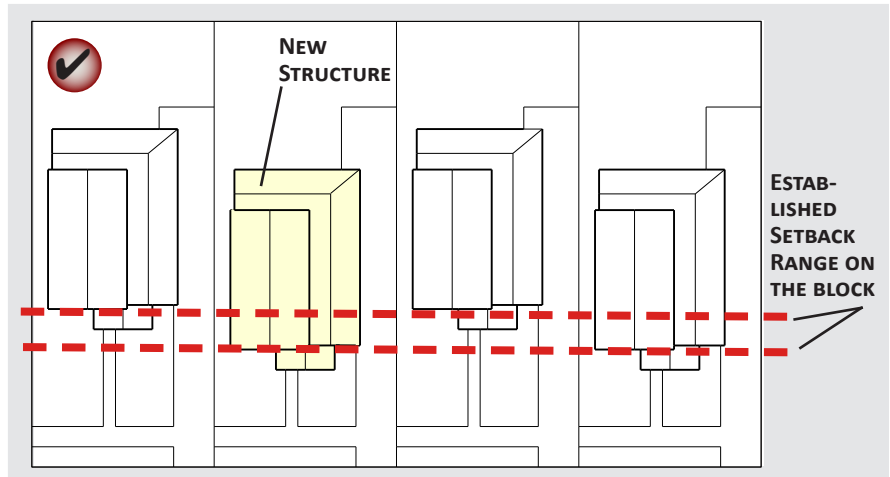

Massing Standards for New Residential Construction

Galveston’s traditional residential structures have varied heights, articulated masses and pedestrian-scaled fronts that convey a sense of human scale.

While it may be larger than a traditional residential structure in the surrounding context, a new residential structure in a locally-designated historic district should appear to be similar in mass and scale to those seen historically in the block.

A special consideration is the design of a multifamily building in a single family context. Where this is permitted by zoning, a new multifamily building in a single family context should reflect façade widths of traditional single family structures in the area.

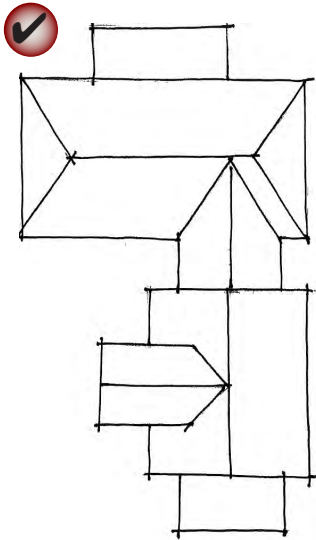

Subdividing the mass of a larger building into smaller “modules” that are similar in size to buildings seen traditionally is encouraged.

3.24 Construct a new structure to reflect the mass and scale of historic residential structures in the area.

Appropriate

- Subdivide the mass of a larger building into smaller “modules” that are similar in size to buildings seen traditionally.
- Design building features to incorporate traditional dimensions. Wall plate heights, window and door head heights and other vertical proportions should match the appropriate scale of the period.
- Design corner buildings be similar in height to buildings along adjoining blocks.

3.25 Express façade components in ways that will help to establish a human scale.

Appropriate

- Include horizontal elements in the design of residential buildings that help to express the height of floors and that relate visually to similar features in the block. For example, use a porch and groupings of windows to convey human scale.
- Articulate a building mass to create visual interest and convey a three-dimensional form. Provide vertical and horizontal wall offsets to reduce the overall scale of a building.
- Design a new residential façade to respect the traditional proportions of height to width.
- Use floor-to-ceiling heights that appear similar to those of traditional residential buildings.
- Consider window proportions, pairing and trim in the design.



A sense of human scale is achieved when one can reasonably interpret the size of a building by comparing features of its design to comparable elements in one’s experience. Using building materials of a familiar dimension such as traditional brick or wood lap siding is an example, as is using windows, doors and porches of similar dimensions.

Appropriate Residential Massing

While it may be larger than a traditional residential structure in the surrounding context, a new residential structure in a locally-designated historic district should appear to be similar in mass and scale to those seen historically on the block as illustrated below.

New Structure Broken Down into Modules

Although it is larger than existing structures on the block, the new residential structure illustrated at right is broken down into modules that are similar in size to traditional buildings in the surrounding context. The two-story portion of the structure has also been set back from the street to help preserve the traditional one-story appearance of the block face.

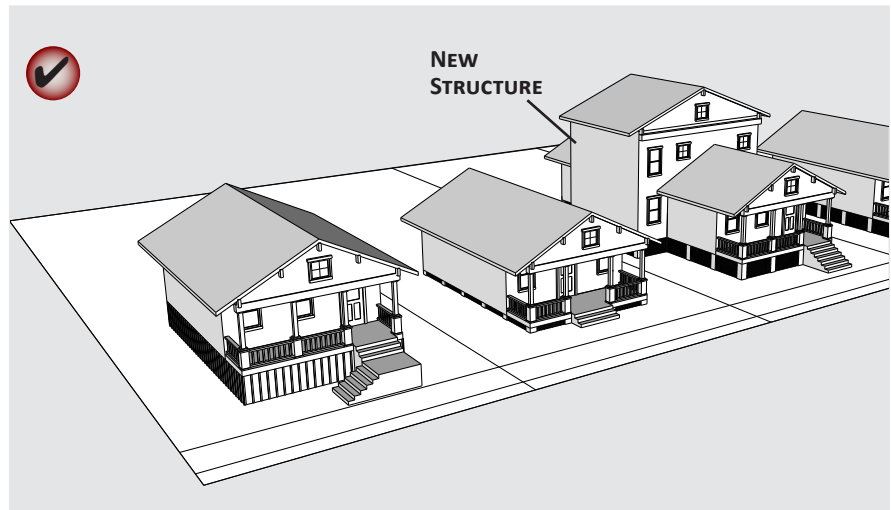

New Structure that is Inappropriately Scaled

The new structure illustrated at right does not appear to be in scale with traditional buildings in the surrounding context. The new structure's two-story front façade and long side walls loom over the streetscape and adjacent, smaller scale, structures.

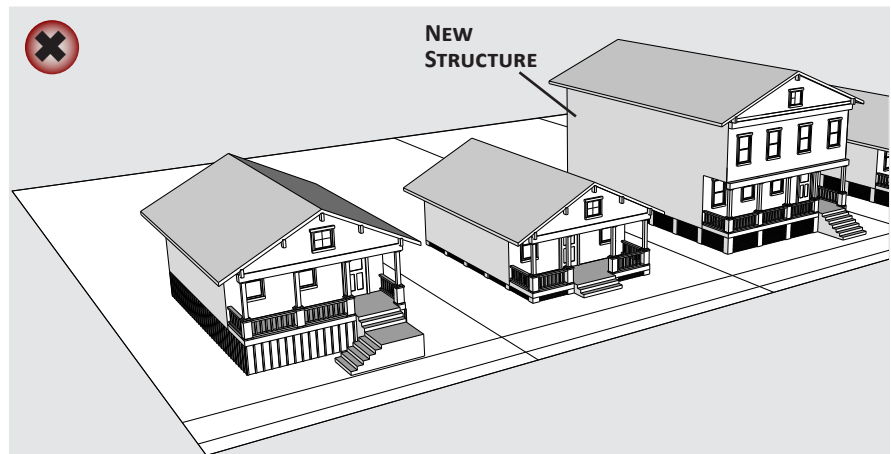



For larger buildings with more than two units, define individual units in modules that express traditional dimensions.

3.26 Position taller portions of a structure away from neighboring buildings of lower scale.

Appropriate

- Where permitted by the base zoning, taller structures should be located to minimize looming effects on lower scaled neighbors.
- The height of first floors should be aligned whenever possible.
- A building should step down toward any lower, adjacent historic properties.

3.27 Organize the massing of a new multifamily building to appear similar in scale to historic structures in the context.

Appropriate

- For larger buildings with more than two units, define individual units in modules that express traditional dimensions.

BUILDING FORMS

A similarity of building forms also contributes to a sense of visual continuity. In order to maintain this feature, a new building should have a basic form that is similar to that seen traditionally.

3.28 Use simple, rectangular building forms.

Appropriate

- Use building forms that appear similar to traditional forms.

Inappropriate

- Unless necessary, do not use building forms that do not have a traditional orientation to the street.

3.29 Use building and roof forms similar to those seen traditionally in the district.

Appropriate

- Use a pitched or gable roof form where they exist in the surrounding historic context.

Inappropriate

- Do not use an exotic roof form on the primary structure.
- Do not use shed roof forms except on porches or small additive forms attached to the primary structure.



Simple rectangular building forms are preferred.

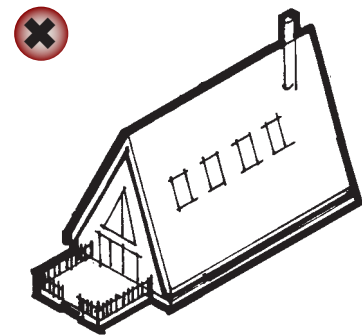

Building forms that do not have a traditional orientation to the street or traditional floor heights are discouraged.

Appropriate Building Form

A new residential structure should have a simple form. Complex building forms that do not have traditional floor-to-ceiling heights are inappropriate.

Simple Building Form

Simple building forms composed of primarily rectangular elements and traditional floor-to-ceiling heights (generally 9-10') are most appropriate in Galveston's residential historic districts.

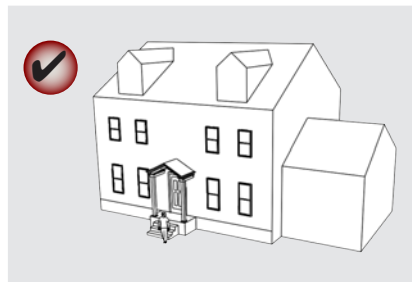

Inappropriately Complex Building Form

Complex building forms that do not have traditional floor-to-ceiling heights (below 9'), or incorporate multiple architectural styles, are inappropriate.





Design a new residential structure to reflect its time.

Building Standards for New Residential Construction

New residential structures in locally-designated historic districts should incorporate building features that promote compatibility with the surrounding context.

Note that the “Standards for Elevated Residential Foundations” on page 80 also apply to the foundation elevation of new residential construction.

ARCHITECTURAL CHARACTER

Design a new building to be visually compatible with nearby historic houses, while conveying the evolution and history of the area.

3.30 Design a new residential structure to reflect its time.

Appropriate

- Use contemporary interpretations of historic architectural styles when designing a new residential structure.
- Reflect current architectural trends in a new residential structure to convey the period in which it is built and continue to accurately portray the evolution of the community.

Inappropriate

- Do not imitate or copy the historic architectural styles of Galveston in the design of a new building.
- Do not imitate or copy historic architectural styles that are not native to Galveston to avoid confusing the architectural traditions of the community.

3.31 Use new interpretations of architectural features that are common to historic residences in the district.

- Use porch columns, balustrades, brackets, rafter ends, windows, doors and other historically-appropriate trim elements.

Inappropriate

- Do not use historic details that were not found in Galveston.

PORCHES AND ENTRIES

A street-oriented front porch and entry is a distinctive characteristic of most historic houses in Galveston, and should be incorporated into new construction.

3.32 Design a front entry to be compatible with the historic context.

Appropriate

- Orient a front porch towards the street and sidewalk.
- Proportion a front porch to be compatible with the architectural style of the building and surrounding historic context.

3.33 Design a porch to be compatible with the historic context.

Appropriate

- Use materials similar to those seen historically. Wood balustrades and porch posts (sometimes with brick piers) were most common.
- Use sufficiently substantial porch posts and columns so that the porch does not appear to float above the entry.

Inappropriate

- Do not visually overwhelm the primary façade.



A street-oriented front porch and entry is a distinctive characteristic of most historic houses in Galveston.

Appropriate Porch Proportions

A new residential structure should incorporate a properly-proportioned front porch.

Properly-Proportioned Porch

As illustrated at right, a front porch should be properly proportioned to the building style.

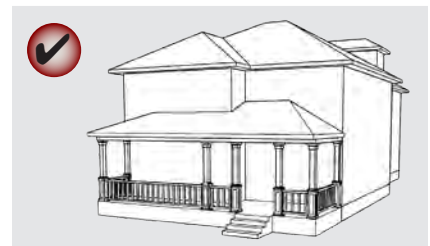
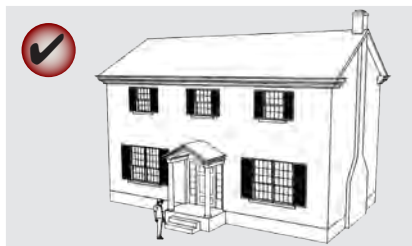

Inappropriately Proportioned Porch

As illustrated at right, oversized porches that are not properly proportioned to the building style are not appropriate.

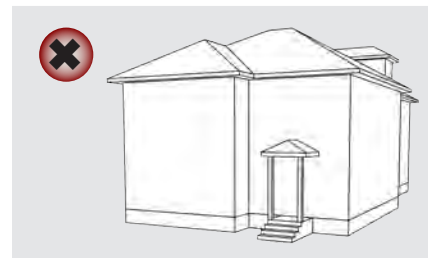
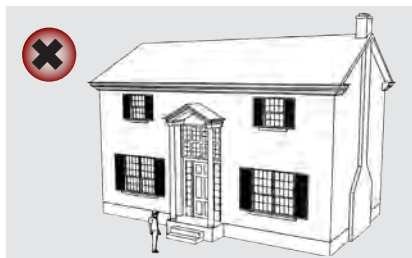



Cementitious lap siding may be used on new buildings when the appearance is similar in scale, character and finish to that of wood siding.

BUILDING MATERIALS

Use building materials that appear similar to those used traditionally in Galveston. Building materials of a new structure should be compatible with adjacent historic houses. They should appear similar to those seen traditionally to establish a sense of visual continuity.

3.34 Use building materials that are compatible with the surrounding context.

Appropriate

- Use wood siding with a weather-protective, painted finish, or masonry (brick, stone or genuine stucco) as the primary exterior building material (preferred approach).
- Consider using alternative materials that are similar to traditional materials in scale, proportion, texture if they have proven durability in the local climate (i.e., cementitious fiber board with a smooth finish).

Inappropriate

- Do not use highly reflective materials such as glass or polished metal as a primary building material.

3.35 When using horizontal lap siding, ensure that it is applied in a manner similar to that seen historically.

Appropriate

- Use new siding that is similar to the lap exposure, texture and finish of traditional wood siding.
- When possible, use trim boards that show depth and typify high-quality construction.

Inappropriate

- Do not use a finish that is out of character, such as a raised grain, or rusticated surface.

3.36 When using masonry, ensure that it appears similar in character to that seen historically.

Appropriate

- Use brick with a modular dimension similar to that used traditionally.
- Consider using stucco for appropriate architectural styles.

Standards for New Secondary Buildings on Residential Properties

These *Design Standards* apply to the design of a new secondary structure. These include garages, garage apartments, garden sheds and alley houses.

3.37 Design a secondary structure to be subordinate in scale to that of the primary building.

Appropriate

- If a proposed secondary building is to be wider than one lot, break up the mass into smaller modules that reflect traditional secondary structures.

3.38 Locate a new secondary structure to be in line with others in the district.

- Traditionally, these are located along an alley edge.

3.39 Use materials that appear similar in character to those of the primary structure.

Inappropriate

- Metal buildings are not permitted.

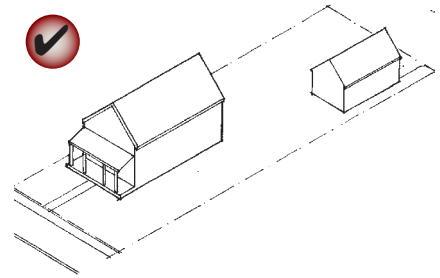

Appropriate: Secondary structure near rear property line

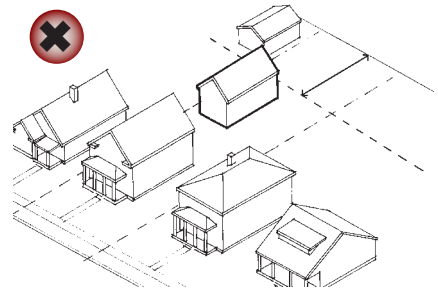

Inappropriate: Secondary structure out of line with others in the context.

Administrative Approval of Garages

As summarized in “Administrative Approval” on page 16, one-story, gable-roofed garages may be administratively approved by the HPO or designated City staff. This applies to a secondary structure that may be on a parcel with a historic, primary building, or one with a new primary structure.

Additions to Non-Historic Residential Structures

An addition to a non-contributing residential structure in a locally-designated historic district should follow the design guidelines for new residential construction beginning on page 85.

Standards for Residential Additions

Additions to locally-designated historic residential landmarks and residential structures in locally-designated historic districts should be compatible with the original structure and surrounding historic context.

Note that treatment of previously-constructed additions that have achieved historic significance in their own right is discussed on page 50.

ADDITIONS TO HISTORIC RESIDENTIAL STRUCTURES

A new addition, if appropriately designed, can be made to a historic building without compromising its historic character. When making an addition to a locally-designated individual historic residential landmark or contributing residential structure in a locally-designated historic district, it is important to consider the relationship with the surrounding historic context and the scale, placement and materials of the addition.

3.40 Design an addition to a historic residential structure to be clearly differentiated from the original structure.

Appropriate

- Use a lower-scale connecting element to join an addition to a historic residential structure.
- Differentiate an addition from the historic original using changes in material, color and/or wall plane

3.41 Keep an addition to a historic residential structure simple in size, shape, materials, color and detail.

Inappropriate

- Do not try to make an addition appear older than it is. This creates a false sense of history and is not permitted.
- Do not disturb the street sides of existing buildings whenever possible.

3.42 Design an addition to a historic residential structure to be subordinate to the primary structure.

Appropriate

- Place an addition to the side or the rear.
- Vertical additions must be placed in the rear so they are not visible from the street or right-of-way.

Locating and Designing an Addition to a Historic Residential Structure

An addition to a locally-designated individual historic residential landmark or contributing residential structure in a locally-designated historic district should be clearly differentiated from the original structure and be subordinately scaled as illustrated below.

Original Structure

The one-and-a-half story bungalow illustrated at right is a contributing structure in a locally-designated historic district.

Birds-Eye View

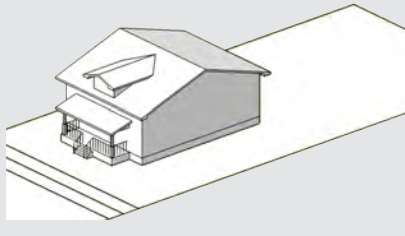

Street View



One-Story Attached Addition

The one-story addition illustrated at right is appropriate because it is clearly differentiated from the original structure with a change in roof plane and is nearly invisible from the street.

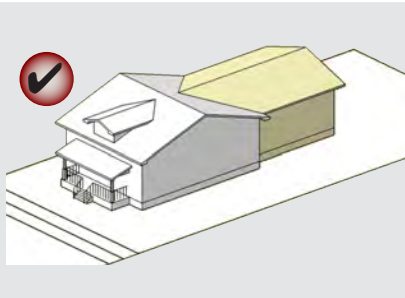

One-and-a-Half Story Addition with Connector

The one-and-a-half story addition illustrated at right is appropriate because it is set back and clearly differentiated from the original structure with a connector.

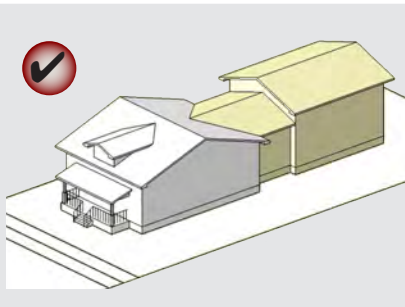

Inappropriate Two-Story Roof-Top Addition

The roof-top addition illustrated at right is inappropriate because it substantially alters the primary façade of the historic structure.

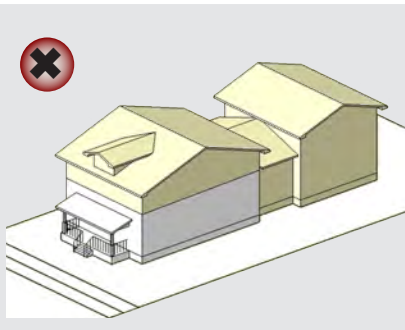



The 1904 Sacred Heart Church at 14th and Broadway

CHAPTER 4

DESIGN STANDARDS FOR COMMERCIAL PROPERTIES

Galveston features an intact historic commercial core centered around the Strand/Mechanic Historic District. Historic commercial buildings are also located in commercial centers and in some residential historic districts. Historic commercial resources require careful stewardship. It is also important for new construction in historic commercial settings to reinforce preservation objectives.

This chapter builds on the general preservation standards presented in Chapter 2 with specific design standards for commercial properties including:

- Rehabilitation, alteration and expansion of locally-designated individual commercial historic landmarks
- Rehabilitation or alteration of contributing commercial structures in locally-designated historic districts
- New commercial construction or additions in locally-designated historic districts

Following a brief summary of Galveston’s commercial development patterns, the standards in this chapter are organized into a general section applicable to all commercial projects, including both historic rehabilitation and new construction, and a section that applies only to new commercial construction and additions in locally-designated historic districts.

Note that additional context-specific design standards for the Strand/Mechanic Historic District are also provided on page 147 in Chapter 5.



In This Chapter

Commercial Development Patterns	100
Design Standards for All Commercial Properties	101
Commercial Site Standards	101
Commercial Building Standards	109
Commercial Signage Standards	115
Design Standards for New Commercial Construction and Additions	121
Massing Standards for New Commercial Construction	121
Building Standards for New Commercial Construction	124
Standards for New Commercial Structures in Residential Districts	129
Standards for New Parking Structures	131
Standards for Commercial Additions	132

COMMERCIAL DEVELOPMENT PATTERNS

Galveston’s historic commercial areas include the grand buildings of downtown and the Strand as well as more modest neighborhood commercial and corner store buildings in historic residential districts. The development of Galveston’s neighborhoods, the economic boom years of the late 19th Century and the constant danger posed by storms and flooding were key influences that helped shape the City’s historic commercial development patterns.



Historic commercial areas in Galveston are highly pedestrian oriented, with buildings built at or near the sidewalk edge and parking areas hidden to the side or rear. Buildings downtown and on the Strand include a wide variety of grand historic styles with flat roofs and masonry exteriors. Historic neighborhood commercial buildings are much more simple and modest and often have pitched roofs and lap siding that match nearby homes.



DESIGN STANDARDS FOR ALL COMMERCIAL PROPERTIES

This section applies to all commercial projects in a historic context. This includes work on locally-designated individual historic landmarks and all commercial rehabilitation and new construction projects in locally-designated historic districts.

Commercial Site Standards

PARKING

The visual impact of surface parking should be minimized. On-site parking should be subordinate to other uses and the front of the lot should be screened.

Also see the City Code for requirements relating to parking lots.

4.1 Minimize the visual impact of on-site surface parking.

Appropriate

- Locate a parking area to the rear or to the interior of a block whenever possible. This is especially important on corner properties. Corner properties are generally more visible than interior lots, serve as landmarks and provide a sense of enclosure to an intersection.

Inappropriate

- Do not use the front setback of a property for parking.

4.2 Site a surface lot so it will minimize gaps in the continuous building wall of a commercial block.

Appropriate

- Where a parking lot shares a site with a building, place it at the rear of the site, or if this is not feasible, to the side of the building.

4.3 Provide a visual buffer where a parking lot abuts a public sidewalk.

Appropriate

- Use a landscaped strip or planter. A combination of trees and shrubs can be used to create a landscape buffer.
- Consider the use of a low or decorative wall as screen for the edge of the lot. Materials should be compatible with those of nearby buildings.

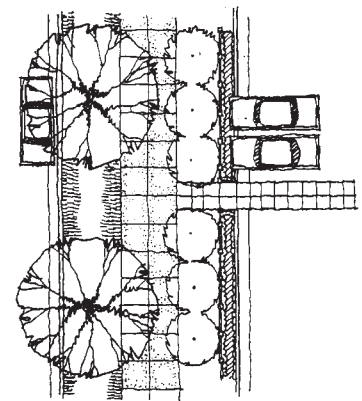
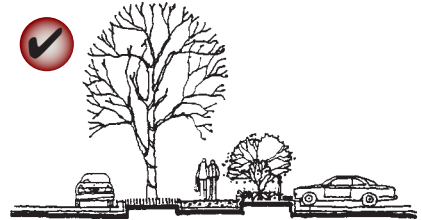

Consider the use of a landscaped strip or planter to provide a visual buffer where a parking lot abuts a public sidewalk.



The historic street and sidewalk network contributes to the character of Downtown Galveston.

CONNECTIVITY

4.4 Retain the historic network of streets and alleys.

Appropriate

- Retain the historic network of streets and alleys as public circulation space and for maximum public access.
- Link to existing public right-of-ways, when feasible.

Inappropriate

- Do not enclose streets and alleys, or close them to public access.

LANDSCAPING

When site development, such as parking, storage and equipment areas, creates an unavoidable negative visual impact on abutting properties or to the public way, it should be mitigated with landscaping or a wall to buffer or screen it.

See the citywide landscape ordinance for additional landscaping requirements.

4.5 Provide a visual buffer for a parking lot or service area.

Appropriate

- Provide a landscape buffer or screen wall at the edge of a parking lot.
- Provide a landscape buffer or screen wall for ground mounted mechanical equipment, service and/or storage areas.
- Plant all trees buffering a parking lot or service areas in the ground rather than in planter boxes or containers.

SITE LIGHTING

The light level at the property line is a key design consideration. This is affected by the number of fixtures, their mounting height, and the lumens emitted per fixture. It is also affected by the screening and design of the fixture. Light spill onto adjacent properties and into the night sky should be minimized.

See the City Code for requirements relating to parking lighting, and “Additional Context-Specific Design Standards for the Strand/Mechanic Historic District” on page 147 for additional site lighting requirements.

4.6 Shield lighting to prevent off-site glare.

Appropriate

- Incorporate cut-off shields into fixtures to direct light downward.
- Shield fixtures to minimize light spill onto adjacent properties and into the night sky.

Inappropriate

- Ensure that luminaires (lamps) are not visible from adjacent streets or properties.

4.7 Provide lighting for a pedestrian way that is appropriately scaled to walking.

Appropriate

- Mount lights for pedestrian ways on short poles or consider using light posts (bollards).

4.8 Ensure that light fixtures are in character with the setting.

Appropriate

- Use fixtures that are compatible with architectural and site design elements.
- Maintain existing spacing patterns for light fixtures.
- Use incandescent light or “warm” light sources.

Site Lighting Design

The design of site lighting should be compatible with its function.



Pedestrian Lighting should be mounted on short poles or provided by light posts (bollards).

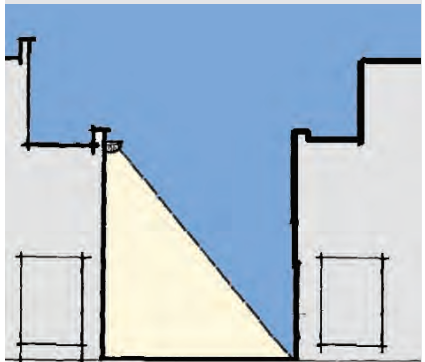

Plaza or Courtyard Lighting should evenly cover usable areas.

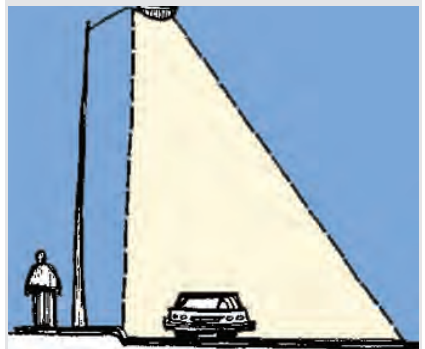

Street Lighting should minimize light spill onto adjacent properties and the night sky.



Locate a public plaza or courtyard to complement the character of the surrounding context.



A courtyard sitting area is encouraged.

PLAZAS, COURTYARDS AND PATIOS

Small plazas and courtyards are appropriate in historic commercial areas, as are raised or at-grade patios and seating areas. Such site features should be designed to promote active, pedestrian-oriented streets while protecting the surrounding historic character.

4.9 Locate a public plaza or courtyard to complement the character of the surrounding context.

Appropriate

- Ensure that the gap in the streetwall is proportioned to maintain the strong, urban line of buildings.

4.10 Design a plaza or courtyard to be activated by pedestrian activity.

Appropriate

- Locate a plaza or courtyard to be level with, and directly accessible from, the public sidewalk.
- Include amenities that invite the use of a public plaza or courtyard such as:
 - Street furniture
 - Public art
 - Historical/interpretive marker

4.11 Locate patios and dining areas and raised decks to minimize visual impacts on the streetscape.

Appropriate

- Consider locating an at-grade dining area to the side or rear of a property.
- Place decks to the side or rear of a property (preferred).
- Set back a rooftop deck from the building façade. Decks located near the front façade should include only seating areas.

Inappropriate

- Do not obstruct a sidewalk with an at-grade patio or dining area.
- Do not use projecting or cantilevered decks unless they are appropriate for the specific setting or are located on the rear of the building and do not negatively impact neighboring historic resources.

SIDEWALK AMENITIES AND STREET FURNITURE

Sidewalk amenities and street furniture consist of items normally located in or adjacent to the city right-of-way and are intended for the benefit of the public. Sidewalk amenities include sidewalk paving and curbing materials, handicap access ramps, etc. Newspaper racks, benches, planters, phone booths, bike racks, trash receptacles, etc. are all referred to as street furniture. The pedestrian way should always be preserved for safe and convenient movement. The restoration of curbing using original materials is encouraged. The original curb and sidewalk material can sometimes be found under the surface materials and those features should be preserved.

4.12 Preserve historic sidewalk materials.

Appropriate

- Preserve poured concrete walkways and curbs.
- Preserve brick, limestone and granite features.

4.13 Design new sidewalks to be consistent with the existing context.

Appropriate

- Ensure that new sidewalk materials have a color and texture consistent to the building and the surrounding paving.
- Ensure that sidewalk elevations are consistent with adjacent sidewalks.

4.14 Design site furnishings to complement the character of a building or site.

Appropriate

- Install compatible trash receptacles. Please consult City staff for information on approved receptacles and the sidebar on “Obtaining a Permit to Use the City Right-of-Way.”
- Consolidate newspaper stands and racks into modular newspaper dispensers whenever possible.
- Use simple containers that complement the surrounding context when planting small potted plants and ornamental trees in front of buildings.



Use small potted plants and ornamental trees to complement the building and site.

Obtaining a Permit to Use the City Right-of-Way



Property owners must apply for a permit to install permanent outdoor seating, canopies, balconies, trash receptacles or other outdoor uses in the City right-of-way.

The Galveston Planning Commission reviews all License to Use permit applications. The Landmark Commission also reviews applications in locally-designated historic districts.

Planning Commission License to Use permit applications are available from the Planning Division or online at:

www.cityofgalveston.org/online_services/forms/forms_online.cfm

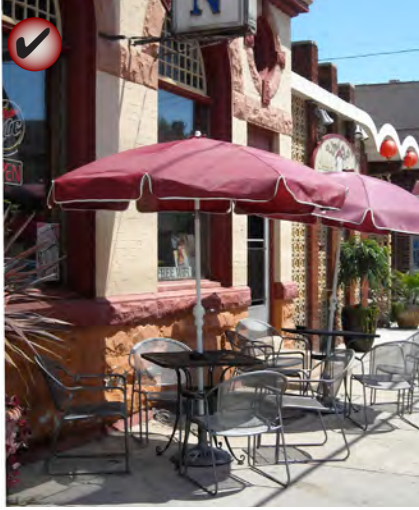

Design and place patio umbrellas to maintain pedestrian circulation.

4.15 Design and place umbrellas to maintain pedestrian circulation.

Appropriate

- Install no more than one umbrella for every 14 linear feet of storefront to be placed according to the individual sidewalk amenities at the site.
- Use umbrellas that are no greater than 7' diameter and are associated with table and chairs.
- Install an umbrella to maintain a minimum clearance of 7' above the surface of the sidewalk elevation in order to provide adequate circulation space below.
- Keep umbrellas upright; no tilting of the umbrellas will be permitted. The umbrellas shall be set back from adjacent business right-of-way by 1'.
- Construct an umbrella pole of either wood or powder coated metal.
- Use a canvas-type umbrella material suitable for outdoor use. No plastic fabrics, plastic/vinyl laminated fabrics, or any type of rigid materials, are permitted for use as umbrellas within an outdoor seating area.
- Ensure that umbrellas placed in the right-of-way match the placement and the design shown in the site plan.
- Ensure that all items are removed from the right-of-way at end of business hours.

Inappropriate

- Do not use umbrellas with decorative borders such as fringes, tassels, or other such ornamentation.
- Do not use umbrellas with any fluorescent or other strikingly bright or vivid color. Umbrella covers must be of one solid color from the approved color palette.
- Do not use umbrellas that include signage for the business or for any other entity in the form of working, logos, drawings, pictorial or photographic representations, or any other likewise identifying characteristic.
- Do not bore into the sidewalk to install an umbrella (not that the applicant must provide umbrella holders).

PUBLIC ART

Public art is welcomed as an amenity. It should be serve as an integral component of the urban environment and be strategically located to serve as accent to a streetscape, plaza, park or other public area.

Note that the Landmark Commission will not review the content of public art, but will evaluate its location and potential impact on a surrounding historic district.

4.16 Use public art whenever possible.

Appropriate

- Incorporate art that complements the historic context.
- Strategically place public art at civic facilities to serve as accents.

4.17 Ensure that public art is compatible with the historic context.

Appropriate

- Ensure that art installation does not impede interpretation of the historic character of the district.
- Locate public art such that the ability to perceive the character of historic buildings nearby is maintained.

Inappropriate

- Do not place a large sculpture in front of a historic building.

4.18 Locate public art to enhance the urban environment.

Appropriate

- Locate artwork in strategic locations such as gateways or as focal points in public plazas or parks.
- Incorporate public art with streetscape furnishings. An artist could “customize” or reinterpret conventional features of a streetscape. For example, an artist might design a gate feature, tree grate or planter.



The use of art forms is encouraged. The top image demonstrates an art form that has been integrated into a transit stop. The lower image shows sculptures located at public entry ways.



Service areas should be visually unobtrusive and should be integrated with the design of the property.

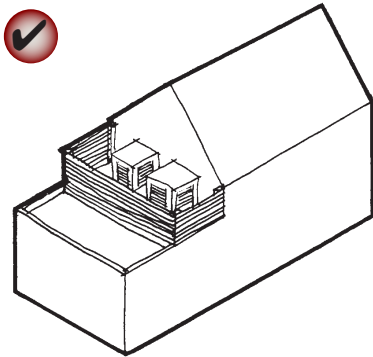

Minimize the visual impacts of mechanical and HVAC equipment on the public way and surrounding neighborhood.

SERVICE AREAS

A service area should be visually unobtrusive and should be integrated with the design of the site and the building.

4.19 Orient a service entrance, waste disposal area and other similar uses toward service lanes and away from major streets.

Appropriate

- Screen a service entrance with a wall, fence or planting.

4.20 Position a service area to minimize conflicts with other abutting uses.

Appropriate

- Minimize noise impacts by locating sources of offensive sounds away from other uses.
- Use an alley when feasible.

4.21 Minimize the visual impacts of service areas.

Appropriate

- Screen a service area with a wall, fence or planting.
- Screen and paint restaurant vent areas.
- Ensure that a service area in character with the building and site it serves.

Commercial Building Standards

HISTORIC COMMERCIAL FAÇADES

Historic commercial façades in Galveston typically have a number of character-defining features that convey the historic significance of the property and also promote visual interest. Such features should not be altered, obscured or removed.

4.22 Preserve the character-defining elements of a historic commercial façade.

Appropriate Features to Preserve

- **Cornice molding:** A decorative band at the top of the building.
- **Upper-story windows:** Windows located above the street level often have a vertical orientation.
- **Mid-belt cornice:** A decorative band at the top of the first floor.
- **Sign band:** A flat band running above the transoms to allow for the placement of signs.
- **Transom:** The upper portion of the display window, separated by a frame.
- **Display windows:** The main portion of glass on the storefront, where goods and services are displayed.
- **Entry:** Usually set back from the sidewalk in a protected recess.
- **Kickplate:** Found beneath the display window.

Character-Defining Elements of a Historic Commercial Façade

Historic commercial façades in Galveston typically feature a tall ground floor (12' to 18' is typical) storefront level and upper stories with shorter floor-to-floor heights (12' to 14' is typical). The key character-defining features of a commercial façade are illustrated below.

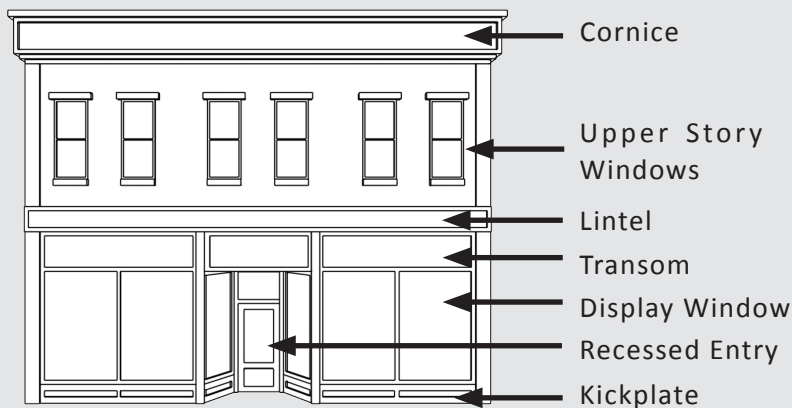

Treatment of an Altered Historic Cornice



Existing Building. When an existing has an altered cornice, two primary treatment options are appropriate as illustrated below.



Reconstructed Cornice. It is appropriate to reconstruct a missing cornice when historic evidence is available.



Replacement Cornice. It is appropriate to replace the altered cornice with a simplified interpretation if complete evidence of the original cornice is not available.

4.23 Repair an altered storefront to its original design.

Appropriate

- Use historic photographs when determining the original character of a storefront design.
- Consider alternative designs that are contemporary interpretations of traditional storefronts where the historic façade is missing and no evidence of it exists (the new design should continue to convey the character of typical storefronts).

4.24 Retain the kickplate as a decorative panel.

Appropriate

- If the original kickplate is covered with another material, consider exposing the original design.
- If the original kickplate is missing, develop a sympathetic replacement design (Wood is an appropriate material for a replacement on most styles but alternative materials may also be considered when appropriately used with the building style).

4.25 Preserve the character of the cornice line.

Appropriate

- Continue the repetition of the cornice line along the street to contribute to the visual continuity on the block.
- Reconstruct a missing cornice when historic evidence is available.
- Use a simplified interpretation for a replacement cornice if evidence of the original is missing (appropriate replacement materials include brick, stamped metal, wood and some durable synthetics).

4.26 Retain the original shape of the transom in a historic storefront.

Appropriate

- Do not remove or enclose a transom (the upper glass band of traditional storefronts which introduce light into the depths of the building and save on light costs).
- Preserve the historic transom shape and configuration.
- Use new glass if the original glass is missing. However, if the transom must be blocked out, be certain to retain the original proportions. One option is to use it as a sign panel or decorative band.

COMMERCIAL CANOPIES

Traditionally, canopies were noteworthy in the commercial areas of Galveston. They provided a continuous, shaded walkway that protected pedestrians from the elements. Canopies also provided an extension of the interior space that helped cool the building. Their continued use is encouraged. See Chapter 2 for design standards regarding awnings.

4.27 Consider reconstructing a commercial canopy that existed historically.

Appropriate

- Accurately reconstruct a missing historic canopy based on sufficient documentation.
- Position a canopy to be consistent with historically-established canopy heights. When the original height is not known, use a height level with the second floor or that of other canopies on the block.
- Do not use architecturally salvaged canopy poles unless adequate documentation and historical research support their use.



Administrative Approval of Canopy Repair and Improvement



As summarized in “Administrative Approval” on page 16, some commercial canopy repair and improvement work may be administratively approved by the HPO or designated City staff including:

- General repair of an existing canopy that does not change its physical structure or general appearance
- Installation of a balcony railing, balustrade or barrier where an owner can document the historic existence of such a feature (Note that balcony rails, balustrades and barriers are not generally typical features of Galveston’s commercial canopies).

All other canopy installation, repair, improvement is subject to review by the Landmark Commission.

4.28 Minimize impacts to historic buildings and canopies when adding new balcony railings balustrades or barriers.

Appropriate

- Use both design and materials to differentiate a new railing or barrier from historic balcony designs.
- Design a new railing or barrier to be simple and compatible with the architecture of the building.
- Ensure that the railing or barrier is as transparent as possible while still adhering to the City’s adopted building code.
- Install a railing or barrier so that it may be removed in the future without impairing the essential form and integrity of the historic building and canopy.

Inappropriate

- Do not obscure character-defining features of the building with a barrier or railing.
- Do not replicate existing building features that can create a false sense of historical development.
- Do not destroy or damage character-defining features of the historic building or canopy when installing a railing or barrier.



Design a new railing to be as transparent as possible so that it does not obscure the character-defining features of the building.

4.29 Design a new canopy or awning to be in character with the building and streetscape.

- Design a new canopy to follow the historical precedent of the district.
- Mount an awning or canopy to accentuate character-defining features.
- Fit the awning or canopy with the opening of the building.
- Design an awning to be a subordinate feature on the façade.
- Use colors that are compatible with the overall color scheme of the façade. Solid colors are encouraged.
- Use simple shed shapes for rectangular openings.
- Use metal canopy columns that are relatively slender in diameter, typically four to six inches (4" to 6"), and have little or no ornamentation.
- Design a canopy with a relatively narrow fascia height —no more than 8-12".
- Locate the face of a canopy a minimum of 24" from the curb.

Inappropriate

- Do not install a canopy when utility easements exist in the city right-of-way.
- Do not impede pedestrian movement with a canopy.
- Do not place the support poles for a canopy in the middle of a sidewalk. Poles must be placed as close to the curb as allowed (24").
- Do not use canopy poles that are highly decorative.
- Do not use odd shapes, bull nose awnings and bubble awnings.
- Avoid placing signage on balconies and awnings. In unusual circumstances where signage is allowed on awnings, the square footage of that sign shall count toward the total square footage allowed for the subject building. "Awning or Under Canopy Signs" on page 118 for more information.
- Do not internally illuminate an awning.



Mount a new canopy to accentuate character-defining features, as shown in the three images above.

Appropriate Color Combinations

Three colors are generally sufficient to highlight a building façade.

Base Color. This appears on the upper wall and frames the storefront. The major expanses of space on a storefront will be painted this color.

Major Trim. This defines the decorative elements of the building and ties the upper façade trim with the storefront. The major trim color must complement the base or body color. Elements include:

- Building and storefront cornice
- Window frames, sills and hoods
- Storefront frames, columns, bulk-heads and canopies.

Minor Trim. This is intended to enhance the color scheme established by the base and major trim colors and may be used for window sashes, doors and selective details. It is typically a darker shade of the major trim color.

Approval of Paint Colors

Several paint colors have been pre-approved by the Landmark Commission for use in locally-designated commercial historic districts. Painting projects using these colors, or the original building colors may be administratively approved by the Historic Preservation Officer without design review by the Commission.

Painting projects that do not use pre-approved colors must be approved by the Commission on a case-by-case basis using the standards at left.

EXTERIOR COLOR

The Landmark Commission reviews exterior color for projects in locally-designated commercial historic districts.

Choosing the right combination of colors for a historic rehabilitation or new construction project can unify building elements with the façade and highlight important architectural detailing. Paint color selection should be appropriate to the architectural style and complement the building and its surroundings.

4.30 Use a façade color scheme that reads as a single composition.

Appropriate

- Use color schemes that are simple in character.
- Use one base color for the building walls and another for the roof.
- Use one to three accent colors for trim elements.
- Return the building to its historic paint colors if adequate archival information is available.

4.31 Use muted base or background colors.

Appropriate

- Use muted colors for building features.
- Use harmonizing or contrasting colors for trim accents.
- Use matte or low luster finishes instead of glossy ones.
- Use non-reflective, muted finishes on all features if possible.

Inappropriate

- Do not use accent colors that contrast so strongly as to not read as part of the composition.
- Do not paint unpainted stone, brickwork or terra-cotta.
- Do not use sandblasting to clean historic surfaces and/or to remove old paint. (See Treatment of Historic Materials and Finishes in Chapter 2.)

Commercial Signage Standards

Signs are used to identify the location of a business and attract customers. Signs on historic commercial properties should be integral to the design of the building and noticeable to customers.

The City’s zoning code provides the basic requirements for signs throughout Galveston. The following design standards supplement the code. See “Additional Context-Specific Design Standards for the Strand/Mechanic Historic District” on page 147 for additional standards.

TREATMENT OF HISTORIC SIGNS

Historic signs contribute to the character of Galveston and have individual value. Historic signs should be retained whenever possible, especially when they are a significant part of a building’s history or design.

4.32 Consider history, context, and design when determining whether to retain a historic sign.

Retaining a historic sign is especially important when it is:

- Associated with historic figures, events or places
- Significant to the building or historic district, or as evidence of the history of the product, business or service advertised
- Characteristic of a specific historic period
- Integral to the building’s design or physical fabric
- Attached in a way that removal could harm the integrity of a historic property’s design or damage its materials
- An outstanding example of the sign maker’s art because of its craftsmanship, use of materials or design
- Recognized as a popular focal point in the community.

4.33 Maintain historic wall signs whenever possible.

Appropriate

- Leave historic painted wall signs, or “ghost signs”, exposed whenever possible.

Inappropriate

- Do not over-restore historic wall signs to the point that they no longer provide evidence of a building’s age and original function.

May be Considered on a Case-by-Case Basis by the Landmark Commission

- The Commission will consider historic wall sign restoration, following appropriate procedures.



Historic signs contribute to the character of Galveston.



Historic painted wall signs, or “ghost signs” should be left exposed whenever possible.

Administrative Sign Approval

Most commercial signage in the Strand/Mechanic Historic District may be administratively approved by the HPO or designated City staff as described on page 148.

Street Level Signs



Street level signs are oriented principally to the pedestrian and are located below the roof level of a one-story building, below the second floor of a multi-story building or are attached to/below a canopy or awning. All other signs attached to a building façade are considered upper level signs.

Grandfathered Signs

Some historic signs may not conform with the City's current sign regulations. However, such signs are generally "grandfathered" and are allowed and encouraged to remain in place with sensitive maintenance and repair.

The City's Historic Preservation Officer (HPO) must approve all changes to grandfathered signs other than color, copy or content. Note that sandwich board signs are not grandfathered.

DESIGN OF NEW AND MODIFIED SIGNS

Whether it is attached to a historic building or associated with new development, a new or modified sign should exhibit qualities of style, permanence and compatibility with the natural and built environment. It should also reflect the overall context of the building and surrounding area.

TOTAL SIGN AREA

The City's zoning code limits the total area of signs on properties throughout Galveston. The following design standards supplement those regulations. When considering a request for additional signage, the Landmark Commission will consider the proportions and design of the façade, the total number of businesses or services per building and the design of the sign(s).

4.34 Limit the total area of signs.

Appropriate

- Design street-level signage so as not to overwhelm the street level of the building façade.
- Use only one upper-level wall sign per building façade.

SIGN INSTALLATION ON A HISTORIC BUILDING

When installing a new sign on a historic building, it is important to maintain the building's key architectural features and minimize potential damage to the historic façade.

4.35 Avoid damaging or obscuring architectural features when installing a sign on a historic building.

Appropriate

- Minimize the number of sign anchor points when feasible.
- Use an existing sign bracket if possible.
- Design a sign to integrate with the architectural features of a historic building.

Inappropriate

- Do not penetrate brick when attaching a sign to a masonry building.
- Do not obstruct the character-defining features of a building with signage.

SIGN LOCATION

A new sign should be located to preserve traditional signage patterns and help direct users toward the primary building entrance.

4.36 Use a compatible sign location.

Appropriate

- Locate a sign above or near the primary entrance to an establishment.
- Locate a sign to emphasize design elements of the historic building façade.
- Mount a sign to fit within existing architectural features using the shape of the sign to reinforce the horizontal lines of the building façade.

SIGN CHARACTER, CONTENT AND LIGHTING

A sign should be in character with the materials, colors and details of the building and its content should be visually interesting and clearly legible.

4.37 Use simple, context-specific sign designs.

Appropriate

- Relate sign content to a business within the building.
- Design a sign to be subordinate to the historic building façade.
- Limit the number of colors used on a sign (three primary colors and additional accent colors are generally sufficient).
- Use one to three simple, easy-to-read typefaces that are similar to traditional typeface designs along the street or block.

4.38 Use sign materials that are compatible with the character and materials of the building.

Appropriate

- Use permanent, durable materials that reflect the Galveston context.

Inappropriate

- Do not use highly reflective materials on a sign.

4.39 Where necessary, use a compatible, shielded light source to illuminate a sign.

Appropriate

- Direct lighting toward a sign from an external, shielded lamp.
- Use a warm light, similar to daylight.
- If halo lighting is used to accentuate a sign or building, locate the light source so that it is not visible.

Inappropriate

- Do not overpower the building or street edge with lighting.



Signs should be visually interesting and clearly legible.

Sign Lighting



When necessary, signs may be lit with compatible, shielded light sources. Note that all sign lighting must conform to lighting requirements included in the City's zoning code.

Sign Materials



Signs should be made with permanent, durable materials. Such materials may include:

- Painted or carved wood
- Individual wood or cast metal letters or symbols
- Stone such as slate, marble or sandstone
- Painted, gilded or sandblasted glass
- Metal signs that are appropriate to the architectural character of the building

Traditional Sign Types

A variety of sign types may be appropriate in Galveston if the sign contributes to a sense of visual continuity and does not overwhelm the character of the building façade.

The City’s zoning code includes location and design standards for several specific sign types. The following design guidelines supplement code standards for several sign types that are potentially appropriate in Galveston.

Awning or Under Canopy Signs

An awning sign lies flat against the surface of the awning material. An under canopy sign is one that is suspended below a canopy and is usually perpendicular to the building face, but may sometimes be parallel.

Awning or under canopy signs are appropriate for areas with high pedestrian activity. They may also be used when other sign types would obscure architectural details. Under canopy signs that are parallel to the building façade should not extend beyond the building wall.



Wall Signs

A wall sign (also called a “flat sign”) is any sign attached to or painted on the outside face of a building. It is erected parallel to the face of the building on which it is supported and may include individual letters, cabinet signs or signs painted on the surface of a wall. Street level wall signs are located on the first floor of a building façade while upper level wall signs are located above the first floor, and may sometimes be painted onto non-primary façade faces.

Wall signs should be placed to align with signs on nearby buildings and should be relatively flush with the building façade, minimizing the depth of a sign panel or letters. They should sit within, rather than forward of, the fascia or other architectural details of a building, ideally within a panel formed by decorative moldings or transom panels where they exist.

When painting a new wall sign, use only board material (wood, metal or PVC composite) or a previously painted masonry surface. It is inappropriate to paint a new wall sign on historic brick that was not previously painted.

See guideline 4.33 on page 115 for information on the proper treatment of historic wall signs.



Window Signs

A window sign is any sign, picture, symbol or combination thereof, designed to communicate information about an activity, business, commodity, event, sale or service that is placed inside within one foot of the inside window pane or upon the windowpanes or glass, and which is visible from the exterior of the window.

Window signs should minimize the amount of window covered and preserve transparency at the sidewalk edge.



Tenant Panel/Directory Signs

A tenant panel or directory sign displays tenant names and locations for a building containing multiple tenants.

Locating a consolidated tenant panel or directory sign near a primary entrance on the first floor wall of a building can help minimize the total number of signs on a building and reduce visual clutter.



Projecting Signs

A projecting sign is attached perpendicular to the wall of a building or structure.

A projecting sign should be designed and located to relate to the building façade and entries. It is appropriate to locate a small projecting sign near the business entrance, just above or to the side of the door or to mount a larger projecting sign higher on the building, centered on the façade or positioned at the corner. The bracket for a projecting sign should complement the sign composition.



Pole Mounted Signs

A pole-mounted/freestanding sign is generally mounted on one or two simple poles.

Pole-mounted signs are not allowed in the Strand/Mechanic Historic District as described in "Additional Sign Standards" on page 148. Where they are allowed, pole-mounted signs should not rise above the storefront level of adjacent buildings and should not include panels that stretch all the way to the ground.

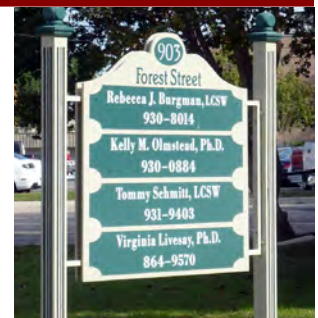
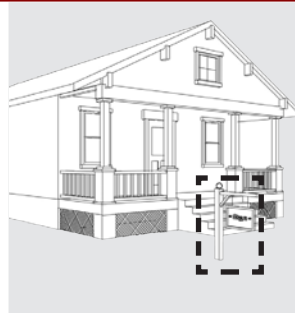

Murals

A mural is a painting located on the side of the building. Mural content should generally reflect a cultural, historic or environmental event or subject matter related to Galveston.

Existing historic murals should be restored whenever possible. The Landmark Commission may consider a new mural painted on the side of a building (a new mural may not be located on the primary building façade) that depicts cultural, historic or environmental events or subject matter from Galveston. It is not appropriate to depict a commercial product brand name or symbolic logo of a product that is currently available, nor is it appropriate to obscure key features of a historic building with a mural. Trompe l’oeil murals that depict architectural features or scenes from Galveston are appropriate.

An accurate color rendering of any proposed mural must be presented to the Landmark Commission. All murals are considered on a case-by-case basis.

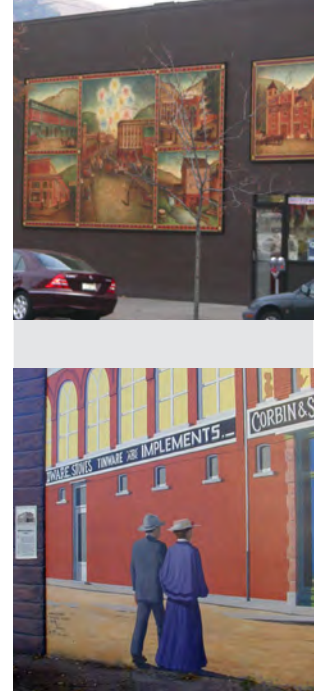
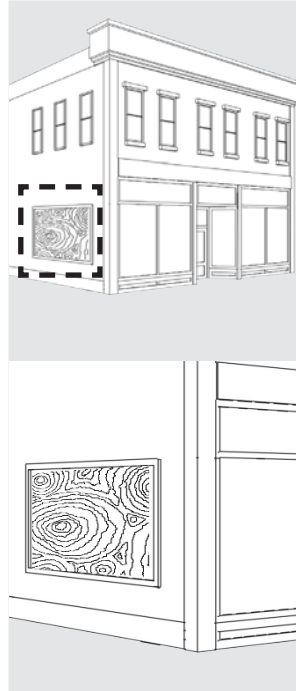

Sandwich Board and Temporary Signs

A sandwich board sign is any freestanding “A-frame type” sign supported by the ground which may or may not be attached to the ground or other objects. Temporary signs include banners, decorations or bunting which commemorate special on-premise events, grand openings or promotional sales.

The City’s zoning code provides the base requirements for sandwich board and temporary signs, including allowed location and duration. Sandwich board signs are generally appropriate only for ground floor businesses, but may be used to advertise upper-story businesses if the character of the sidewalk is not adversely affected. The Landmark Commission reserves the right to limit the number of sandwich board signs per block, to ensure public safety and the historic integrity of the district.

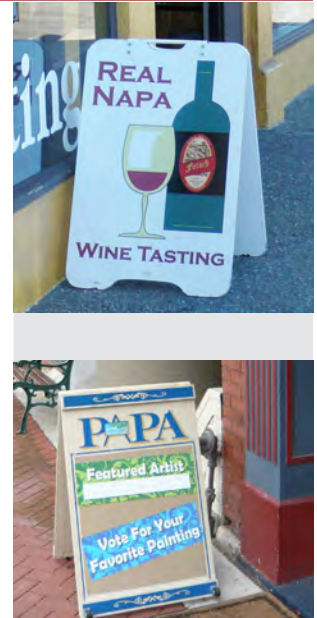

DESIGN STANDARDS FOR NEW COMMERCIAL CONSTRUCTION AND ADDITIONS

This section presents design standards for new commercial construction in locally-designated historic districts and design standards for additions to locally-designated commercial landmarks or contributing commercial structures in locally-designated historic districts. Note that when an addition may alter a locally-designated commercial landmark or a contributing commercial structure in a locally-designated historic district, some design standards in Chapter 2 will also apply.

See “Demolition Considerations” on page 14 for information on the demolition of existing primary and secondary structures to make way for new construction.

Massing Standards for New Commercial Construction

Galveston’s traditional commercial structures have varied heights, articulated façades and pedestrian-oriented street levels that convey a sense of human scale. While they are often visually interesting, these structures are usually composed of simple rectangular forms that contribute to a cohesive streetscape.

A new commercial building in a locally-designated historic district should continue these traditions.

4.40 Maintain the traditional size of buildings as perceived at the street level.

Appropriate

- Design the façade height of a new structure to fall within the range seen historically in the area.
- Design the façade of a new structure to respect the traditional proportions of height to width.

4.41 Establish a sense of human scale in the building design.

Appropriate

- Use vertical and horizontal articulation design techniques to reduce the apparent scale of a larger building mass.
- Incorporate changes in color, texture and materials to help define human scale.
- Use architectural details to create visual interest.
- Use materials that help to convey scale in their proportion, detail and form.



Human Scale



A sense of human scale is achieved when one can reasonably interpret the size of a building by comparing features of its design to comparable elements in one’s experience. Using building materials of a familiar dimension such as traditional brick is an example, as is using windows of similar dimensions.



Use vertical and horizontal articulation design techniques to reduce the apparent scale of a larger building mass.

Base, Middle and Cap Configuration

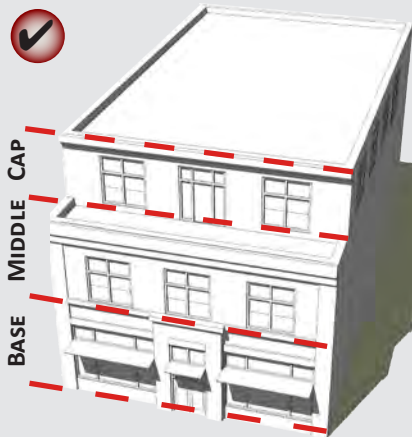

Traditional building façades are generally composed of three primary vertical elements: a base, middle and cap. Designing a new structure to interpret this traditional façade composition will help maintain the visual continuity of Galveston’s historic commercial areas.

4.42 Design building massing to maintain the visual continuity of historic commercial areas.

Appropriate

- Design a commercial façade to be composed of simple, rectangular forms that are consistent with the façade composition of the surrounding context. Any decorative elements and projecting or setback “articulations” should appear to be subordinate to the dominant form.
- Incorporate floor-to-floor heights that appear similar to those of traditional buildings in Galveston, especially at the ground level.
- Design a new structure in to incorporate a traditional base, middle and cap configuration.

4.43 Maintain traditional spacing patterns created by the repetition of uniform building widths along the street.

Appropriate

- Proportion a new façade to reflect the established range of traditional building widths seen in Galveston.
- Where a new structure must exceed a traditional building width, use changes in building configuration, articulation or design features such as materials, window design, façade height or decorative details to break the façade into modules that suggest traditional building widths.

4.44 Position taller portions of a structure away from neighboring buildings of lower scale.

Appropriate

- Where permitted by the base zoning, locate the taller portion of a new structure to minimize looming effects and shading of lower-scaled neighbors.
- Step down the height of a taller structure towards lower scaled neighbors, especially if they have a high level of historic significance.

Reflecting Traditional Building Widths

Historic commercial structures generally reflect the widths of the underlying lots. Designing a new structure to reflect this pattern will help maintain the visual continuity of historic commercial areas.

Traditional Building Widths

In Downtown Galveston and the Strand, traditional lot widths were generally rectangular, with the narrow side facing the street.

Traditional building widths often reflect this pattern, with a series of narrow building façades facing the street as illustrated at right.



New Construction Reflecting Traditional Building Widths

While a new structure may be wider than was historically typical, it should incorporate design features that break it down into smaller modules that suggest the underlying historic lot pattern as illustrated at right.

Changes in building configuration, articulation or design features can help visually break the structure down into smaller modules.

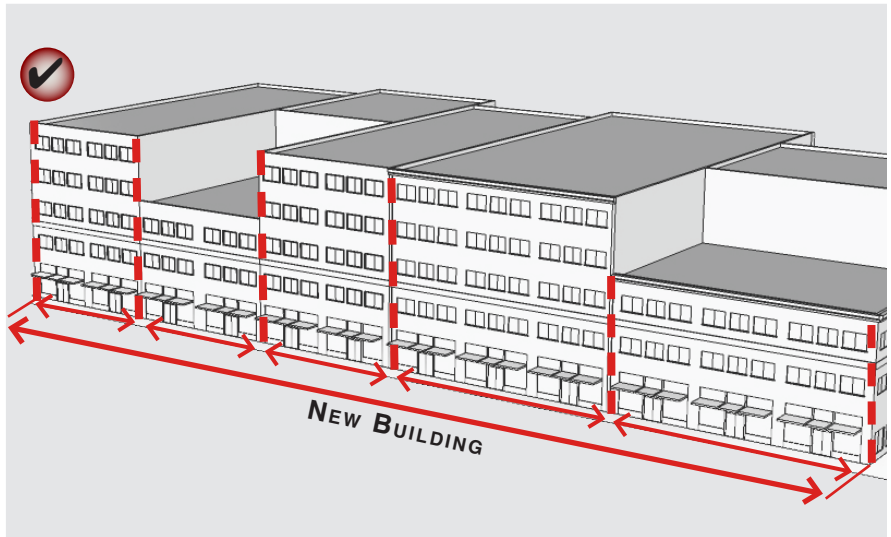



Building Standards for New Commercial Construction

The existing pattern of traditional commercial façades contributes to the continuity of Galveston’s historic commercial areas. Although the imitation of historic architectural styles is discouraged, traditional façade and material patterns should inform the design of new commercial structures in locally-designated historic districts.



Incorporate a high percentage of transparent glass into the first floor of the primary façade and design upper floors to appear more opaque than the street level.

COMMERCIAL FAÇADE CHARACTER

Traditional commercial façade compositions in Galveston feature a clear differentiation between the street level and upper floors. The street level generally appears taller than other floors and has a high percentage of fixed plate glass with a small percentage of opaque framing materials, a kick-plate and a recessed entry. An upper floor, where it occurs, is the reverse—opaque materials dominate, and windows appear as smaller openings puncturing a more solid wall.

The key features of traditional commercial façade character should be referenced in a new commercial façade. See “Character-Defining Elements of a Historic Commercial Façade” on page 109 for more information.

4.45 Maintain the distinction between the street level and the upper floor.

Appropriate

- Incorporate a high percentage of transparent glass into the first floor of the primary façade.
- Design upper floors to appear more opaque than the street level.
- Express the distinction in floor heights between street levels and upper levels through detailing, materials and fenestration. The presence of a belt course is an important feature in this relationship.

Inappropriate

- Do not use highly reflective or darkly tinted glass.

4.46 Maintain the traditional spacing pattern created by upper story windows.

Appropriate

- Use traditional proportions of windows, individually or in groups.
- Maintain the traditional placement of window headers and sills relative to cornices and belt courses.

4.47 Incorporate traditional façade elements in a new commercial structure.

Appropriate

- Express a kickplate, display window and transom in a new storefront design as illustrated in “Character-Defining Elements of a Historic Commercial Façade” on page 109.
- Design storefront components and upper story windows to be similar in height, depth, profile and proportion to traditional downtown buildings.
- When portions of a storefront are folding, ensure that all of the storefront components are still visible.

4.48 Maintain traditional entry patterns along the street.

Appropriate

- Locate the primary entrance to face the street.
- Locate the primary entrance to face the street.
- On commercial type buildings, set a primary entry door back an adequate amount from the front façade to establish a distinct threshold for pedestrians. A recessed dimension of four feet is typical.
- Maintain the upper floor building line at the sidewalk edge where entries are recessed.
- Use a transom over a doorway to maintain the full vertical height of the storefront.

Inappropriate

- Do not use oversized or undersized entry designs.

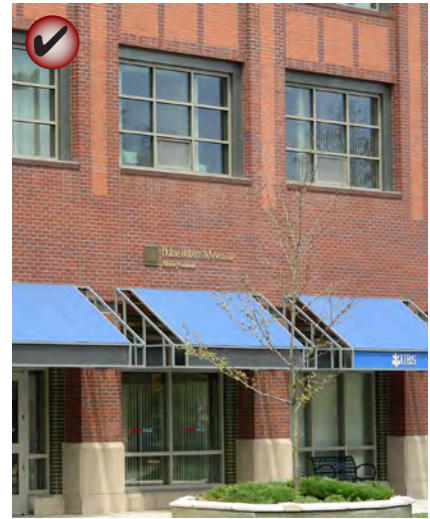

Maintain the traditional spacing pattern created by upper story windows.



Galveston's historic commercial structures typically have recessed, front-facing entries.



A new commercial structure in a locally-designated historic district should maintain the traditional pattern of recessed, front-facing entries.

Contemporary Infill



High quality, contemporary design is preferred for new construction in Galveston’s historic districts. Such buildings should be of their own time and be distinguishable as new, such that the evolution of the district can be understood. At the same time a new building in a historic context should respect the key character-defining features of the setting that help promote visual continuity. These may include the repetition of similar forms, materials, and alignment patterns along the street. Contemporary infill should be a “good neighbor,” that complements the setting and does not impede interpretation of the historic character of the district.

Excellence in design and high quality construction are essential characteristics to maintain in new construction. Contemporary infill should also be massed and detailed to promote compatibility with the surrounding historic context. Using traditional façade articulation patterns and depth of detail will also help promote visual interest and overall compatibility.

Exciting modern design that respects its historic setting is the goal.

ARCHITECTURAL CHARACTER

In order to assure that historic resources are appreciated as authentic contributors, it is important that new buildings be distinguishable from them. Therefore, new construction should appear as a product of its own time, while also being compatible with the historically significant features of the area.

4.49 Design a new building to reflect its time, while respecting key features of its context.

Appropriate

- Reference traditional articulation patterns on the façade of a new commercial structure.
- Use high quality design and depth of detail in building features to enhance compatibility with the historic context.
- Use contemporary details, such as window moldings and door surrounds, to create interest while expressing a new, compatible style.

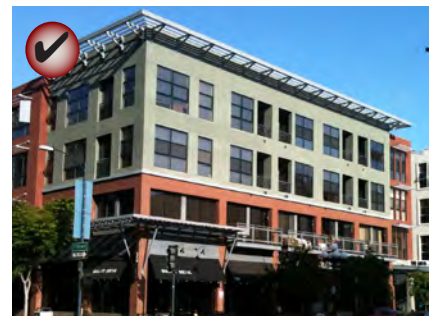

Use high quality design and depth of detail to enhance the compatibility of a new contemporary structure with its historic context.

Reference traditional articulation patterns on the façade of a new commercial structure.

4.50 Do not imitate historic styles in the design of a new structure.

Appropriate

- Design a structure in a contemporary style to avoid blurring the distinction between old and new, which makes it more difficult to visually interpret the architectural evolution of the historic district.
- Design a structure using a contemporary interpretation of a historic style that is authentic to the district while ensuring that it is distinguishable as being new.

Inappropriate

- Do not design a structure to appear old.



Use high quality design and depth of detail to enhance the compatibility of a new contemporary structure with its historic context



MATERIALS

Building materials for new structures and additions to existing buildings should contribute to the visual continuity of the district and appear similar to those seen traditionally.

Masonry, including brick, stone and genuine stucco, was traditionally the primary building material in Downtown Galveston. Within the Strand/Mechanic Historic District, brick was traditionally the primary building material. Traditional commercial structures in the city’s historic residential districts use a wider range of building materials, often including wood siding.



4.51 Use building materials that are compatible with the surrounding context.

Appropriate in the Strand/Mechanic Historic District

- Use brick as the primary exterior building material. Note that other masonry materials such as stone and genuine stucco may be appropriate in Downtown locations outside of the Strand/Mechanic Historic District.

Appropriate for Commercial Buildings in Residential Historic Districts.

- Use wood siding with a weather -protective finish, or masonry (brick, stone or genuine stucco) as the preferred primary exterior building material.
- When necessary, use alternative materials that are similar to traditional materials in scale, proportion, texture and finish and have proven durability in the local climate.

Inappropriate in All Areas

- Do not use highly reflective finishes such as mirror glass or highly polished metal as a primary building material.

4.52 When using masonry, ensure that it appears similar in character to that seen historically.

Appropriate

- Use brick with a modular dimension similar to that used traditionally.
- Consider using cast concrete details that are designed to be similar to stone trim elements.



Using materials of a familiar dimension helps create a human scale.

Standards for New Commercial Structures in Residential Districts

Outside of the Strand/Mechanic Historic District, Galveston's locally-designated historic districts are primarily residential. However, a number of commercial nodes and buildings have historically been located in residential districts, and are an important part of neighborhood identity.

Where permitted by the City's base zoning regulations, new commercial and mixed-use infill buildings are encouraged in residential historic districts. Such buildings should be oriented towards pedestrians and should be compatible with the mass and scale of nearby residential structures and uses. They should also be consistent with the neighborhood development patterns described on page 68.

Note that the overall design standards for new commercial construction and additions are also generally applicable to new commercial and mixed-use construction in residential districts.

4.53 Design a new commercial or mixed-use structure to be compatible with the mass and scale of nearby residential structures.

Appropriate

- Break down the mass of a new structure into modules that relate to the size of nearby historic residential structures.
- Step down the mass and scale of a new structure towards adjoining residential structures.
- Provide a landscape buffer between a new structure and adjoining residential structures.



The traditional commercial structures along 14th Street in the East End Historic District relate to the scale of adjoining residential structures and are highly pedestrian oriented.

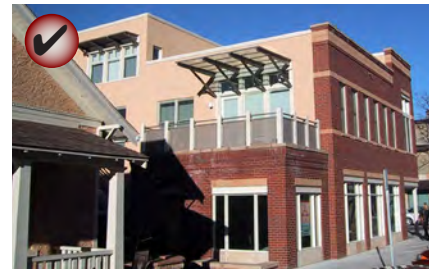

Step down the mass and scale of a new commercial or mixed-use structure towards adjoining residential structures.



A new commercial or mixed-use building in a residential historic district should be built near the sidewalk edge, have a primary entry directly accessible from the sidewalk and incorporate a high level of ground floor transparency.

4.54 Design a new commercial or mixed-use structure to be pedestrian-oriented.

Appropriate

- Locate a substantial portion of a new commercial or mixed-use structure near the sidewalk edge.
- Provide outdoor seating or plaza areas adjoining the street.
- Locate the primary building entry to be directly accessible from the sidewalk.
- Provide a storefront or other space with a high level of transparency on the ground floor.

Inappropriate

- Do not place parking between the building and a primary street (note that parallel or other on-street parking is appropriate.)



A new commercial structure should be located near the sidewalk edge like this historic commercial structure along 23rd Street near the Silk Stocking Historic District.

Standards for New Parking Structures

Decreasing the area of parking at street level helps to support an active street and pedestrian-friendly environment. When designing a parking structure, create a frontage or 'wrap' of commercial or residential accommodation. The parking structure can reflect the historic character of the area and positively contribute to the quality of the street frontage and streetscape.

4.55 Provide an active street edge.

Appropriate

- Wrap a parking structure or stack it above retail or other active uses at the street edge.
- Utilize storefronts, display cases, architectural detailing, and landscaping at street level.

4.56 Design a street-facing façade to reflect traditional patterns of commercial buildings in the area.

Appropriate

- Design street-facing façades with the same attention to architectural detail and materials as a primary building façade.
- Use street-front façade articulation to reflect the pattern and rhythm of street fronts in the traditional context.
- Screen automobiles from view.

4.57 Provide for ease of pedestrian use.

Appropriate

- Provide a clearly defined and direct connection between a parking structure and the street.
- Clearly identify and conveniently locate pedestrian equipment such as elevators.

4.58 Locate drive access in secondary areas.

Appropriate

- Provide vehicular access from secondary streets or alleys.
- Locate service areas away from primary street façades.



Wrap or stack retail space around parking structures.

Locating an Addition to a Historic Commercial Structure

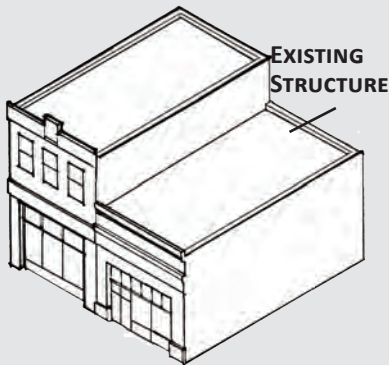

Existing Structure.

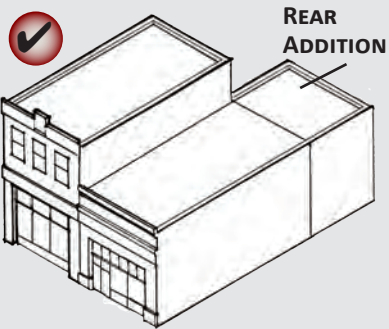

Rear Addition. As illustrated above, a rear addition is appropriate.

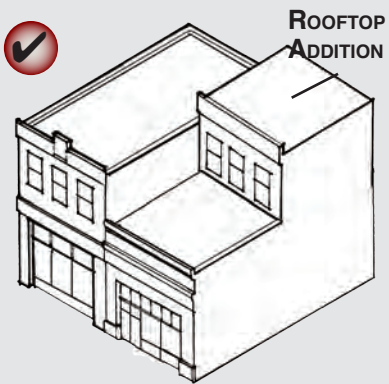

Rooftop Addition. As illustrated above, a rooftop addition set back from the front façade is appropriate.

Standards for Commercial Additions

Additions to locally-designated historic commercial landmarks and commercial structures in locally-designated historic districts should be compatible with the original structure and surrounding historic context.

Two distinct types of additions to historic commercial buildings may be considered. First, a ground-level addition that involves expanding the footprint of a structure. Such an addition should be to the rear or side of a building. This will have the least impact on the character of the building. Second, an addition to the roof may be designed that is subordinate in character and set back substantially from the front. In addition, the materials, window sizes and alignment of trim elements on the addition should be compatible with those of the existing structure.

Greater flexibility on less visible façades is appropriate. (See “Locating Façade Improvements” on page 29 for more information on selecting the most appropriate places for alterations.)

Note that treatment of previously-constructed additions that have achieved historic significance in their own right is discussed on page 50.

4.59 Design an addition to be compatible with the main structure.

- Design an addition to appear subordinate to the original building in mass, scale, character, and form.
- Design an addition to be distinguishable as new, albeit in a subtle way.
- Use a compatible roof form.
 - An addition with a pitched roof is usually inappropriate for a building with a flat roof.
- Do not locate an addition to the front of the primary façade.

4.60 Do not damage or obscure architecturally important features when adding an addition.

Inappropriate

- Avoid damaging historic façades, cornice lines or other details.

4.61 Design a roof addition to be compatible with the historic structure.

Appropriate

- Set a roof addition back from the primary, character-defining façade, to preserve the perception of the historic scale of the building.
- Minimize the visibility of a roof addition from the street.
- Design a roof addition to be simple and modest in character, so it will not detract attention from the historic façade.

4.62 Design a side addition to be compatible with the historic structure.

Appropriate

- Recess the façade of a side addition at least 18" from the original building façade.

Additions to Non-Historic Commercial Structures

An addition to a non-contributing commercial structure in a locally-designated historic district should follow the design guidelines for new commercial construction beginning on page 121.



The historic structure illustrated above has a rooftop addition that is set back from the primary façade to be minimally visible from the public street and sidewalk.

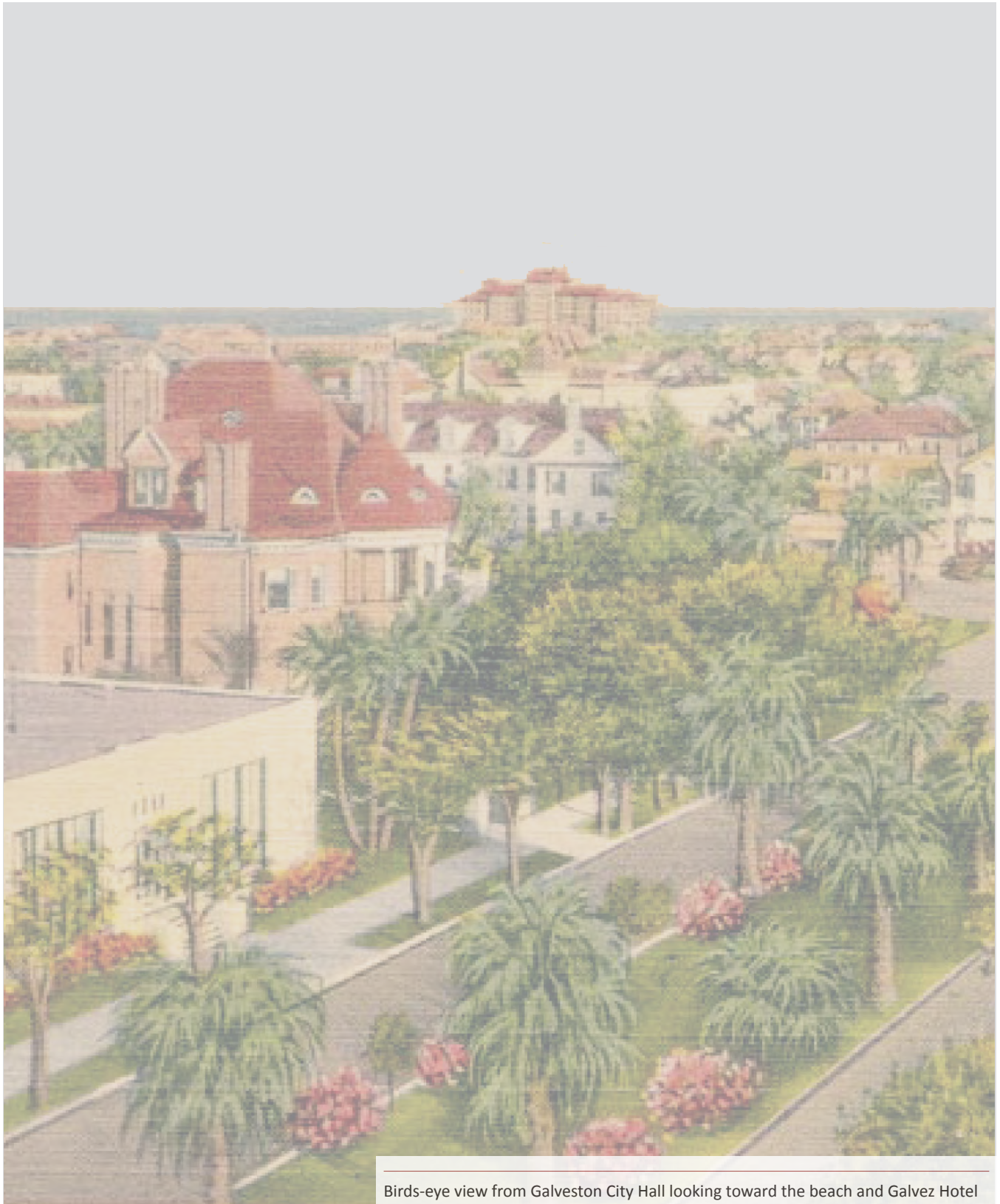

Birds-eye view from Galveston City Hall looking toward the beach and Galvez Hotel

CHAPTER 5

LOCAL HISTORIC DISTRICTS

Galveston’s locally-designated historic districts comprise a significant portion of the eastern part of the city. They range from the grand commercial structures of the Strand/Mechanic District to the more modest residential context of the Lost Bayou Historic District. The community seeks to preserve and promote the key features and general design traditions of each of its local historic districts.

This chapter provides context-specific information to support application of the design standards within each of Galveston’s locally-designated historic districts, including:

- Historic background on the development of the district
- A brief summary of design traditions and key features
- A brief summary of concerns or issues
- A brief summary of community objectives for the district

This chapter also includes additional context-specific design standards for the Strand/Mechanic Historic District. If additional local historic districts are designated in the future, a section describing each district will be added to this chapter.



In This Chapter

East End Historic District	137
Design Traditions	137
Concerns and Objectives.....	139
Lost Bayou Historic District	141
Design Traditions	141
Concerns and Objectives.....	141
Silk Stocking Historic District	143
Design Traditions	143
Concerns and Objectives.....	143
Strand/Mechanic Historic District	145
Design Traditions	146
Concerns and Objectives.....	146
Additional Context-Specific Design Standards for the Strand/Mechanic Historic District.....	147

Map 5.1: East End Historic District

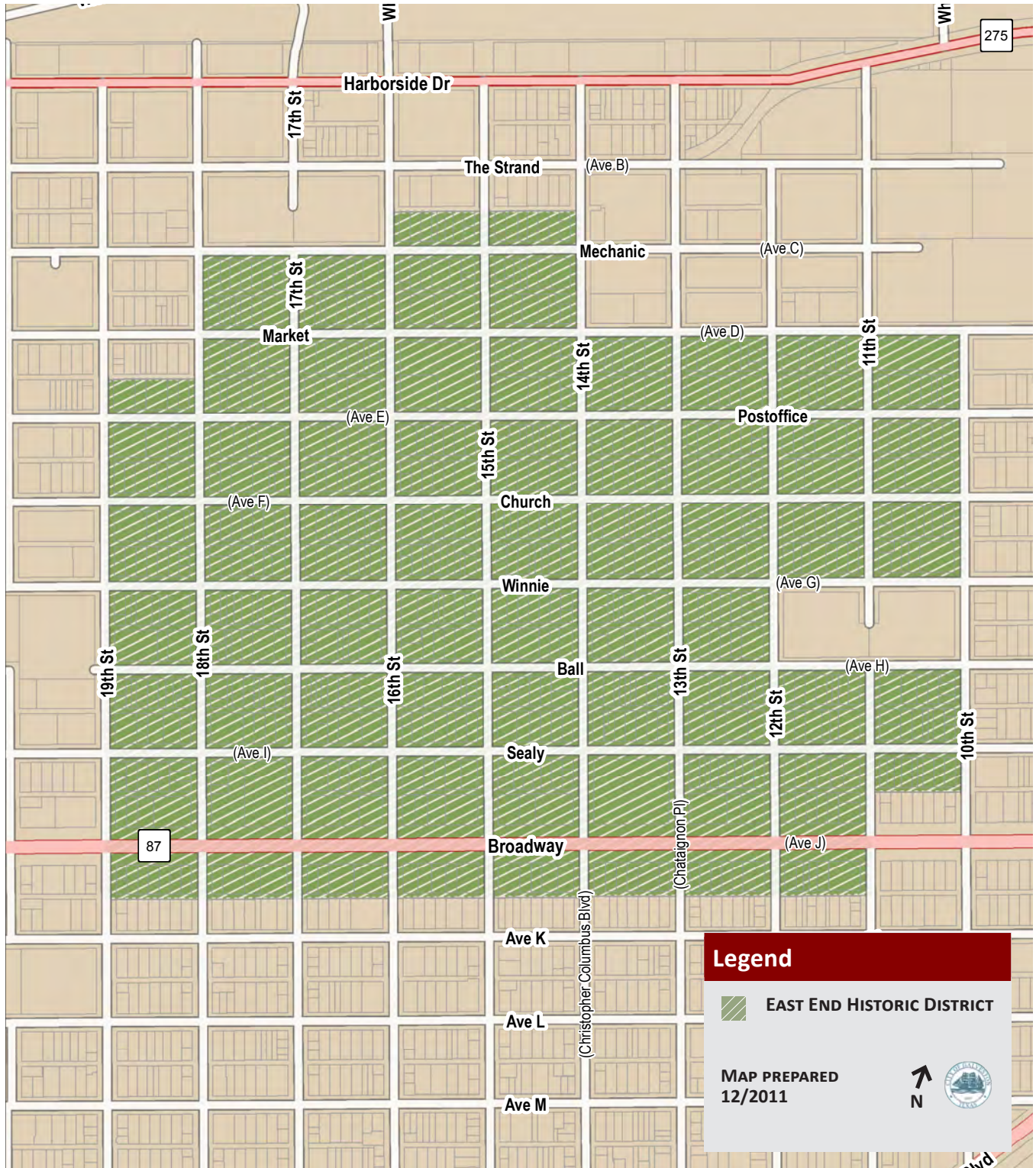

EAST END HISTORIC DISTRICT

The East End, located directly adjacent to downtown, was Galveston's first residential neighborhood. It became Galveston's first locally-designated historic district in 1971. The original 40 block historic district was expanded to the east and north in 1994. It is also listed on the National Register of Historic Places.

The densely populated East End suffered significant damage in the Great Fire of 1885, with houses destroyed from 16th to 20th streets and from the Strand past Broadway. The tight grid pattern of lots and the existence of multiple alley residences made fighting the fire difficult within the neighborhood. Rebuilding was swift, with entire blocks rebuilt in 1886. This provided ample opportunity for local architects such as Nicholas Clayton, Alfred Muller and George Stowe, to design elegant Victorian residences throughout the district.



Design Traditions

The East End neighborhood follows the grid pattern laid out in the initial 1838 survey of the eastern portion of the island, with fourteen lots per block and an alley running east–west, separating north and south lots. Prior to the Civil War, many landowners would build slave quarters to the rear of their properties, along the alley. Once slavery was abolished, servants would often live in these alley residences or rental properties were built along the alley to provide additional income.¹ This created a pattern in the East End that continued for decades: wealthy and poor living in close proximity without middle-income families.

Historically, the streetscapes of the East End were dynamic, with structures sometimes being moved into and out of the district. As Galveston houses were generally built on piers, these dwellings could be easily picked up and moved to new locations. Often speculators would purchase property in valuable areas, such as the East End, and would lease the land to individuals who would then move their own house on to the land.

1600 Block of Market

The 1600 Block of Market in the East End Historic District was one of the first blocks to be rebuilt after the Great Fire, which started one block north in 1885. All existing houses on the block date from 1886.

¹ Beasley, Ellen and Stephen Fox. *Galveston Architecture Guidebook*. Houston: Rice University Press and Galveston Historical Foundation, 1996, page 16.

Darragh Park



Darragh Park, at 519 15th Street, occupies the former site of the J.L. Darragh Mansion (top image), which was destroyed by arson in 1990. The East End Historic District Association has owned and maintained the park since 1995. It features an ornate wrought iron fence, tiled pathways and more than 2,500 plantings.

Key features of the East End Historic District include:

- A diversity of scales from modest to very grand
- Neighborhood-oriented commercial structures and uses (Primarily along 14th Street)
- Alley houses and other outbuildings
- Historic landscape features
- An active and engaged homeowners association



The East End Historic District features a number of neighborhood-oriented commercial structures and uses along 14th Street.

Concerns and Objectives

The East End is generally in good condition, and benefits from highly-engaged residents. However, concerns have been expressed, including:

- The potential height of new construction in the district
- The condition of public infrastructure in the neighborhood
- The growth of Bed and Breakfast and short-term rental uses
- The potential for large apartment projects
- Encroachment from the adjacent University of Texas Medical Branch (UTMB)
- Issues associated with commercial uses on 14th Street
- Roof replacement issues

Future objectives for the district include:

- Exploring potential expansion of the district to protect adjacent historic blocks
- Establishing a stronger edge identity between the district and the UTMB campus
- Encouraging UTMB employees to live in the neighborhood
- Establishing a technical assistance program to assist with roof replacement



The diversity of building scales is a key feature of the East End Historic District. The district includes modest bungalows and grand mansions.

Map 5.2: Lost Bayou Historic District

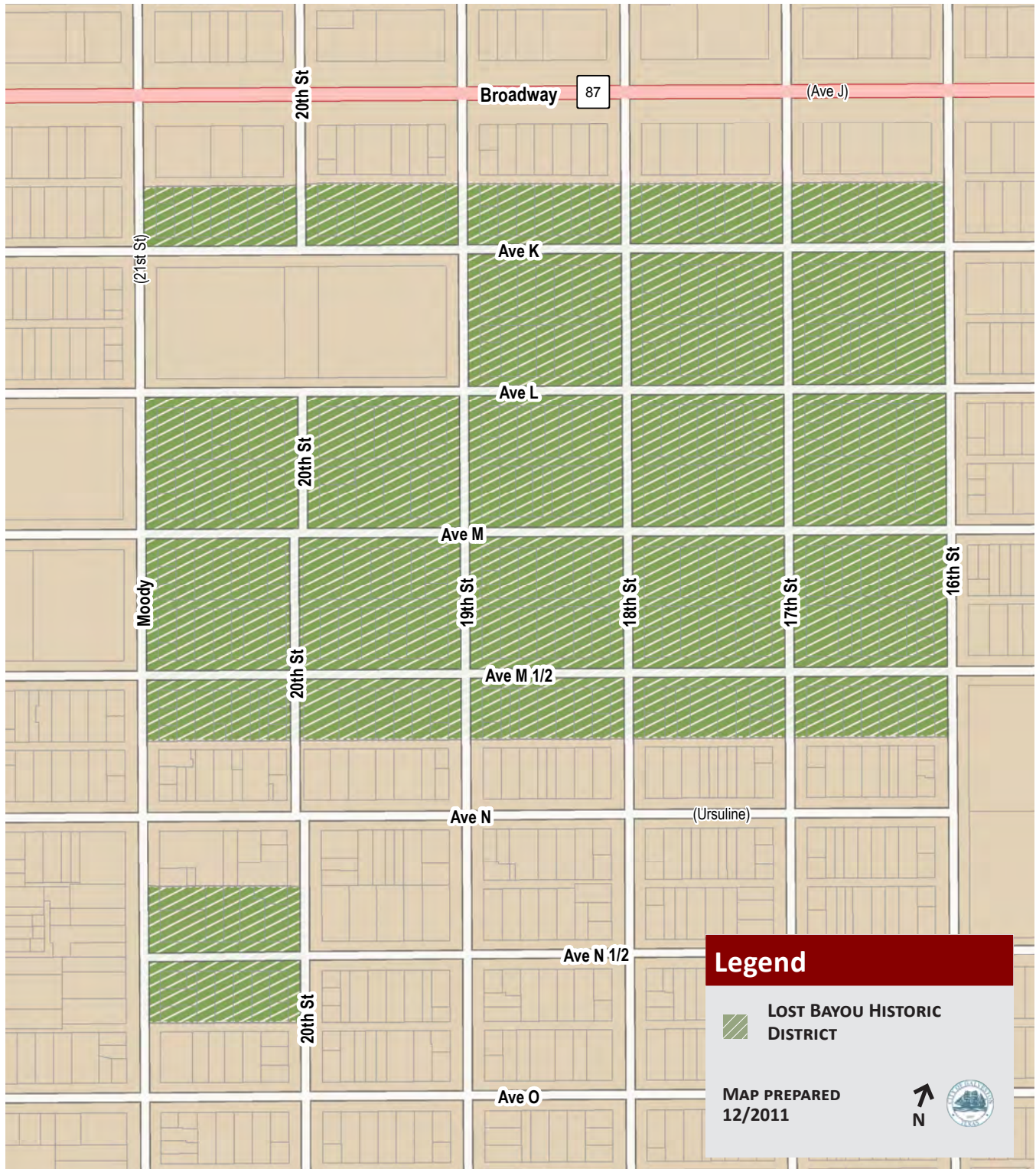

LOST BAYOU HISTORIC DISTRICT

Lost Bayou is Galveston's most recently-designated local historic district. It was originally designated in 1994, and was expanded to include an additional non-contiguous block in 2004. The district is comprised of approximately 23 blocks south of Broadway Boulevard between 21st Street and 16th Street.

Lost Bayou was originally developed around the same time as the East End and Silk Stocking historic districts, although with a slightly smaller scale of residences. The district now includes many early 20th Century structures that were built after the neighborhood was extensively damaged in the Great Storm of 1900.

Design Traditions

Like the East End, the Lost Bayou is laid out in a consistent pattern of square blocks with alleys. Most houses face the east-west avenues, although some houses on each block face the numbered north-south streets.



Key features of the Lost Bayou Historic District include:

- A diversity of building forms and uses
- Structures that are generally modest in scale (compared with those in the East End and Silk Stocking Historic Districts)
- Fragmented district boundaries, with a non-contiguous portion of the district located to the southwest of 28th Street and Avenue M
- The surrounding San Jacinto Neighborhood Conservation District

Concerns and Objectives

Concerns in the Lost Bayou Historic District include:

- The condition of public infrastructure in the neighborhood, including brick curbs
- Overgrown vegetation
- Enforcement of zoning regulations and the *Design Standards*
- Issues associated with the adjacent Gulf Breeze Apartments (City of Galveston Housing Authority)

Future objectives for the district include:

- Encouraging additional historic rehabilitation
- Encouraging compatible foundation elevation or replacement structures for red-tagged buildings



The Lost Bayou Historic District includes a diversity of building forms that tend to be more modest than those seen in the East End or Silk Stocking Historic Districts.

Map 5.3: Silk Stocking Historic District

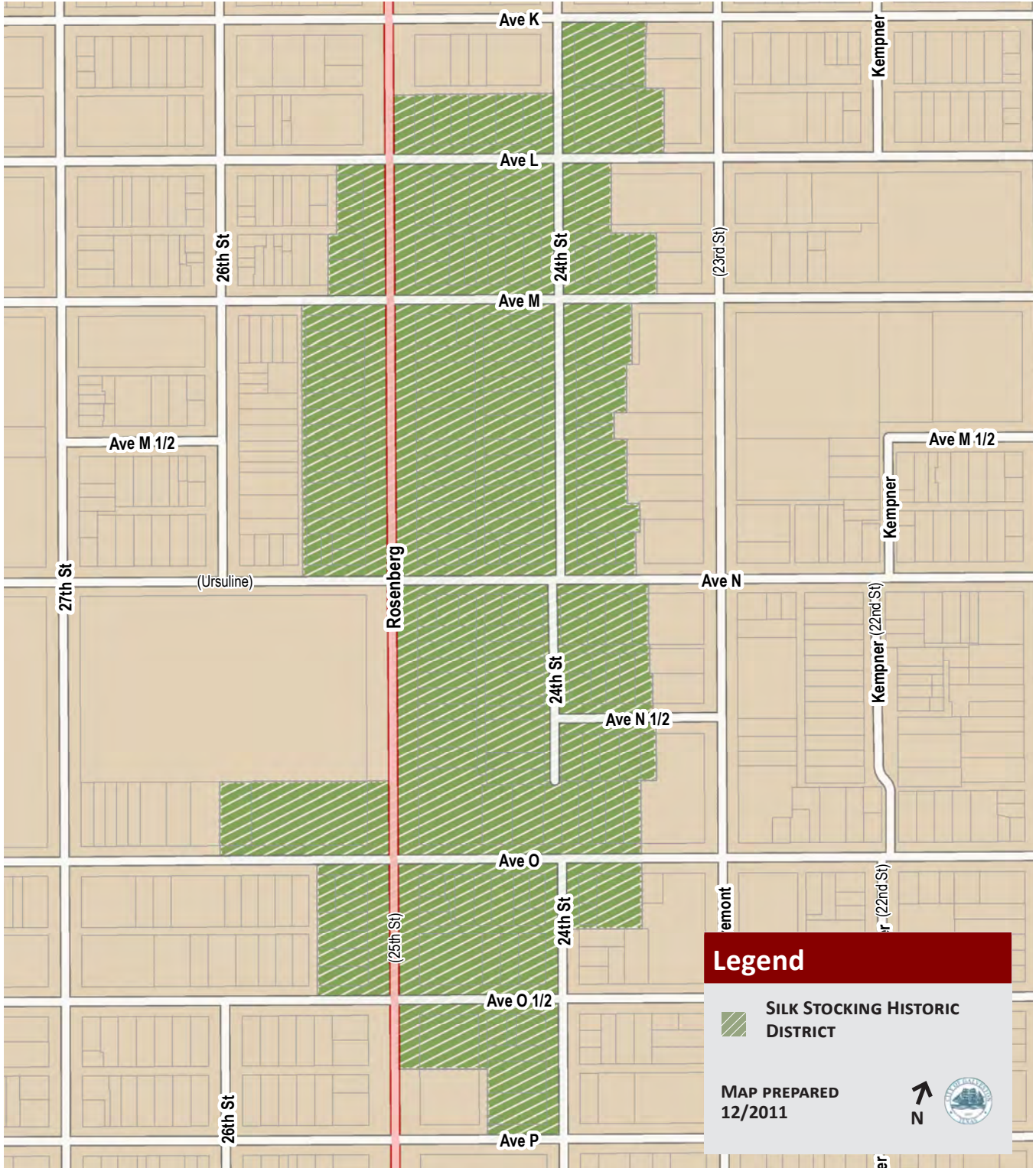

SILK STOCKING HISTORIC DISTRICT

The Silk Stocking local historic district was created in 1975, with 25th Street, or Rosenberg, as the core thoroughfare. The neighborhood is one of the most intact residential areas in the city from the late 19th and early 20th century. It is both a locally-designated historic district and a National Register Historic District.

Silk Stocking was originally developed in the early 1870s as a mix of single-family houses, a small corner store, large vacant blocks and industrial sites. It continued to develop through the 1920s, despite damage sustained in the Great Storm of 1900, which produced a massive wall of debris along Avenue N 1/2. It is now one of the most intact residential areas in the city from the late 19th and early 20th century.



Design Traditions

The Silk Stocking Historic District includes a greater diversity of block shapes than the East End or Lost Bayou Historic Districts. Unlike the other residential historic districts, many houses face the numbered north-south streets, and alleys, where they exist, run north-south.

Key features of the Silk Stocking Historic District include:

- Long north-south blocks
- Dead-end streets that create hidden pockets
- A greater consistency of building forms and uses than other residential historic districts in the city
- A greater consistency of building age than other residential historic districts in the city
- Large, grand houses



The Silk Stocking Historic District features a relatively consistent array of larger single-family houses.

Concerns and Objectives

Concerns in the Silk Stocking Historic District include:

- The condition of public infrastructure in the neighborhood
- Issues associated with commercial uses on 23rd (Tremont) Street, adjacent to the district

Future objectives for the district include:

- Encouraging additional historic rehabilitation

Map 5.4: Strand/Mechanic Historic District

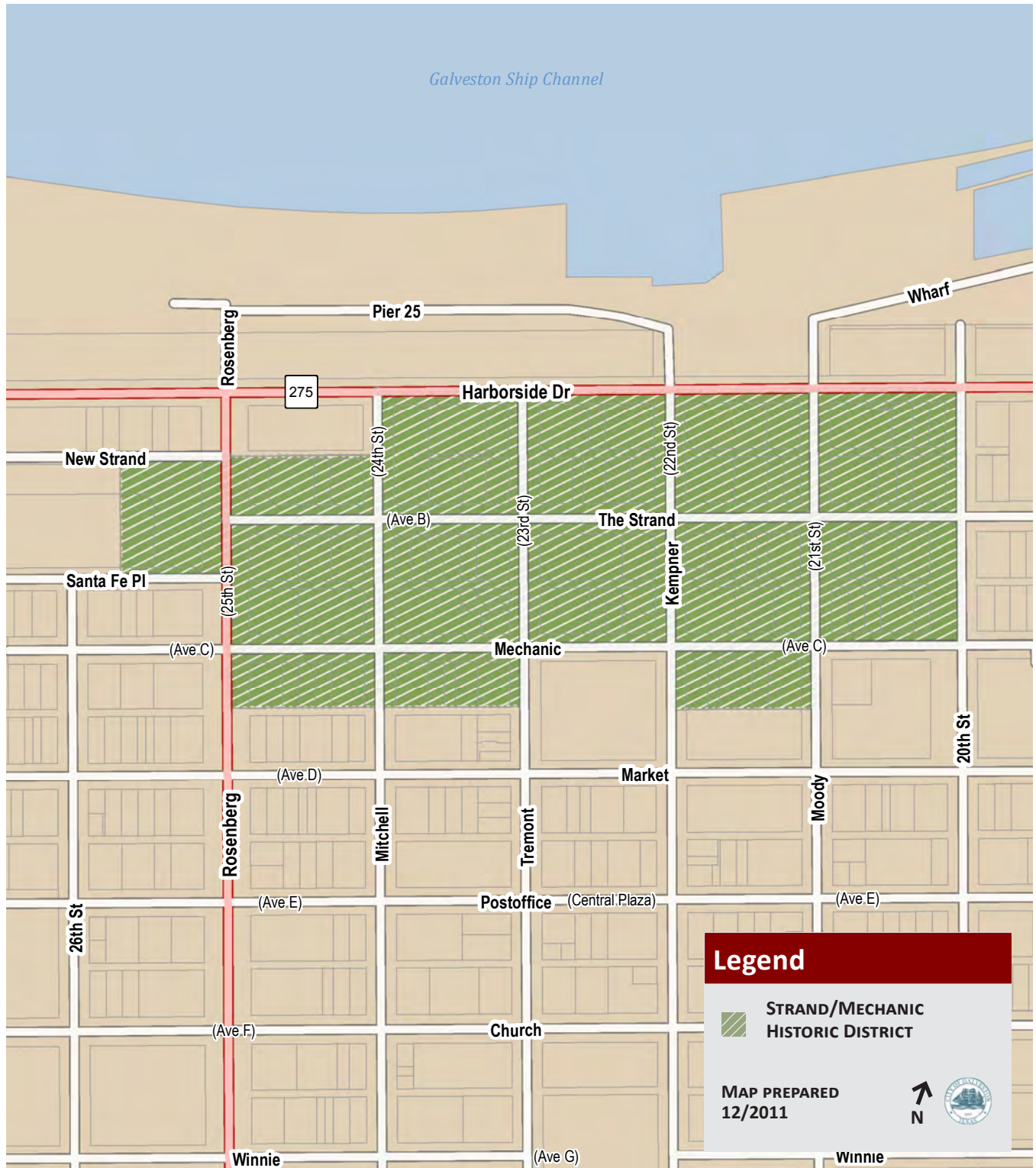

STRAND/MECHANIC HISTORIC DISTRICT

In 1988, the Strand/Mechanic Historic District became Galveston’s first locally-designated commercial historical overlay. The overlay adds special historic protections, but preserves the underlying zoning. The approximately 13 block district encompasses Galveston’s primary commercial area from the 1850s through the early 1900s. It is both a locally-designated historic district and a National Register Historic District.

Often referred to as “the Wall Street of the Southwest,” the Strand/Mechanic area was the economic lifeblood of this 19th century port city. Businesses in the district included banks, warehouses and merchants that supported and managed the heavy traffic of goods coming into and leaving the city. Cotton was the major export but building materials, produce and other dry goods also flowed through the district.



The historic Strand runs from 20th to 25th Street. Most buildings were built between 1875 and 1899, when it was a prosperous business area adjacent to the wharves. Its Gothic, High Victorian, French and Italianate buildings now house shops, restaurants, offices and apartments. It is one of Galveston’s most popular tourist destinations.

Initially, a separate review board was created to review improvement projects in the Strand/Mechanic Historic District. Projects within the district are now reviewed by the citywide Landmark Commission.



The streetscape of The Strand is defined by the continuous row of façades that meet the sidewalk.



Commercial ground level storefronts align in a continuous horizontal bank; upper story windows create the same horizontal continuity.



Buildings of different styles and eras follow basic massing, form and rhythm and create the unique feeling of the district.

Design Traditions

The Strand/Mechanic Historic District is laid out on a consistent pattern of square blocks with alleys running east-west. Buildings in the district are built to the property line and meet the sidewalk, creating an urban, pedestrian-oriented feel. Although most of the area’s earliest buildings were wood frame, they were replaced over time with masonry structures.

Key features of the Strand/Mechanic Historic District include:

- A consistent line of urban, pedestrian-oriented building façades built to the sidewalk edge
- A pattern of ornate three to four-story buildings
- Commercial cast iron storefronts with a ground floor that is at least 1/3 taller than the floor-to-floor heights of upper stories
- Canopies shading the sidewalk
- Commercial buildings converted into residential lofts

Concerns and Objectives

Concerns in the Strand/Mechanic Historic District include:

- Vacancies and non-optimal uses that reduce the district’s potential as an entertainment, retail and tourist destination
- Cluttered sidewalks
- Signage and other merchandising materials that obscure the district’s historic character

Future objectives for the district include:

- Exploring potential expansion of the district to include blocks along Post Office, Market and 25th Streets
- Increasing building occupancy to include additional retail, residential and office uses
- Promoting a more vibrant entertainment, retail and tourist environment within the district

Additional Context-Specific Design Standards for the Strand/Mechanic Historic District

Historic rehabilitation and new construction in the Strand/Mechanic Historic District should comply with all relevant design standards in Chapters 2 and 4 of the Design Standards. Such projects should also comply with the additional context-specific design standards below.

ADDITIONAL SITE STANDARDS

Context-specific site considerations for the Strand/Mechanic Historic District include landscape and lighting design. The Strand was originally lined with telephone and electric wires and shaded by canopies, not street trees. However, the introduction of later landscaping has helped screen parking, service and utility areas and provide additional shade for pedestrians. Any future street tree planting should be part of a master streetscape plan, and should ensure that tree canopies allow for sufficient visibility of historic building façades and storefront details.

Lighting in the district should support its residential and commercial potential, with the general level of illumination kept at a sufficient level to produce a sense of safety without disturbing residents.

See “Commercial Site Standards” on page 101 for general standards that apply to all commercial site design.

5.1 Landscape sites to provide shade and screen parking/utility areas in the Strand/Mechanic Historic District.

Appropriate

- When planting trees along the street, use species that will not block storefront details with their canopies.
- When planting trees along the street, position them 2’ to 3’ from the back of the curb at intervals similar to that of existing trees on the street. The interval should also allow for sufficient visibility of historic building façades.
- Plant trees in the ground rather than planter boxes.
- Use grates or other types of ground cover around the base of a tree.
- Plant trees along the property lines of surface parking lots and vacant lots to help create the sense of a building façade where buildings do not currently exist.
- Use low shrubs and/or low walls (constructed with materials that complement the surrounding context) to screen parking lots.



Although street trees were not an original feature of the Strand/Mechanic Historic District, their later introduction has helped provide additional shade for pedestrians.

Administrative Approval of Commercial Signage in Strand/Mechanic Historic District

Commercial signage in the Strand/Mechanic Historic District may be administratively approved by the HPO or designated City staff if the sign design follows the Design Standards and the conditions listed below.

- Accurate, full color renderings must be submitted for all sign permits.
- Flat signage located on building façades facing Harborside Drive in the Strand/Mechanic Historic District are allowed a maximum square footage of two square feet for each linear foot of the Harborside façade.
- Materials that can be administratively approved for signage in The Strand/Mechanic Historic District are wood, metal and PVC composite. All sign edges must be finished (i.e. no exposed plywood edges). The Landmark Commission must approve all other signage materials.
- Internally lit box signs or channel letters may only be located on the façades of buildings on Harborside Drive. Internally lit signs are not permitted elsewhere in the Strand/Mechanic Historic District. The height of the channel letters may not exceed 30”.
- No fluorescent colors may be used on signage.
- Signage using up to five colors. The Landmark Commission must approve signs using more than five colors.
- External lighting elements should conform to designs previously approved by the Landmark Commission.

Staff reserves the right to require Landmark Commission approval of all proposed signage for the historic districts.

5.2 Use street lighting to maintain a sufficient illumination level in the Strand/Mechanic Historic District.

Appropriate

- Maintain existing gas-light fixtures.
- If replacing or introducing a new street light fixture, duplicate existing gas or electric light fixtures.

Inappropriate

- Do not use mercury vapor or sodium vapor lighting.

May be Considered on a Case-by-Case Basis by the Landmark Commission

- The Commission will consider the appropriateness of lighting on the underside of canopies or building façades, tree lighting in landscaped areas, spill lights in the interior of stores and pole mounted lighting in parking areas.

ADDITIONAL SIGN STANDARDS

Context-specific sign considerations for the Strand/Mechanic Historic District address roof signs and freestanding pole signs.

See “Commercial Signage Standards” on page 115 for general standards that apply to all commercial signs.

5.3 Use signs that are compatible with traditional signage patterns in the Strand/Mechanic Historic District.

Inappropriate

- Do not use roof and freestanding pole signs in the Strand/Mechanic Historic District, with the exception of freestanding historical markers and public information signs.

May be Considered on a Case-by-Case Basis by the Landmark Commission

- Freestanding signs may be considered if there are not practical options for traditional signage or as deemed appropriate by the Landmark Commission.



ADDITIONAL STANDARDS FOR NEW CONSTRUCTION

Context-specific considerations for new construction in the Strand/Mechanic Historic District include maintenance of the strong street wall and general roof patterns.

Buildings in the Strand/Mechanic Historic District possess common elements. Combined, these elements express the individual structure and contribute to the overall character of the district. These elements are part of the basic exterior building design and include the scale, massing, orientation and alignment, cornice and eave height, proportions, floor-to-floor heights, and building patterns, also called rhythm.

See “Design Standards for New Commercial Construction and Additions” on page 121 for general standards that apply to all new commercial construction.

5.4 Maintain a strong, pedestrian-oriented street wall in the Strand/Mechanic Historic District.

Appropriate

- Design a new structure to directly adjoin other buildings with shared party walls.
- Design a new structure to maintain the existing strong façade line.

5.5 Maintain traditional façade proportions in the Strand/Mechanic Historic District.

Appropriate

- Design the storefront level with a floor-to-floor height that is at least 1/3 taller than that of the upper stories.

5.6 Design a roof form to be compatible with the character of the Strand/Mechanic Historic District.

Appropriate

- Use a flat roof form or other roof form that is concealed by a parapet.
- Use a mansard roof form.



New construction in the Strand/Mechanic Historic District should maintain a strong, pedestrian-oriented street wall.

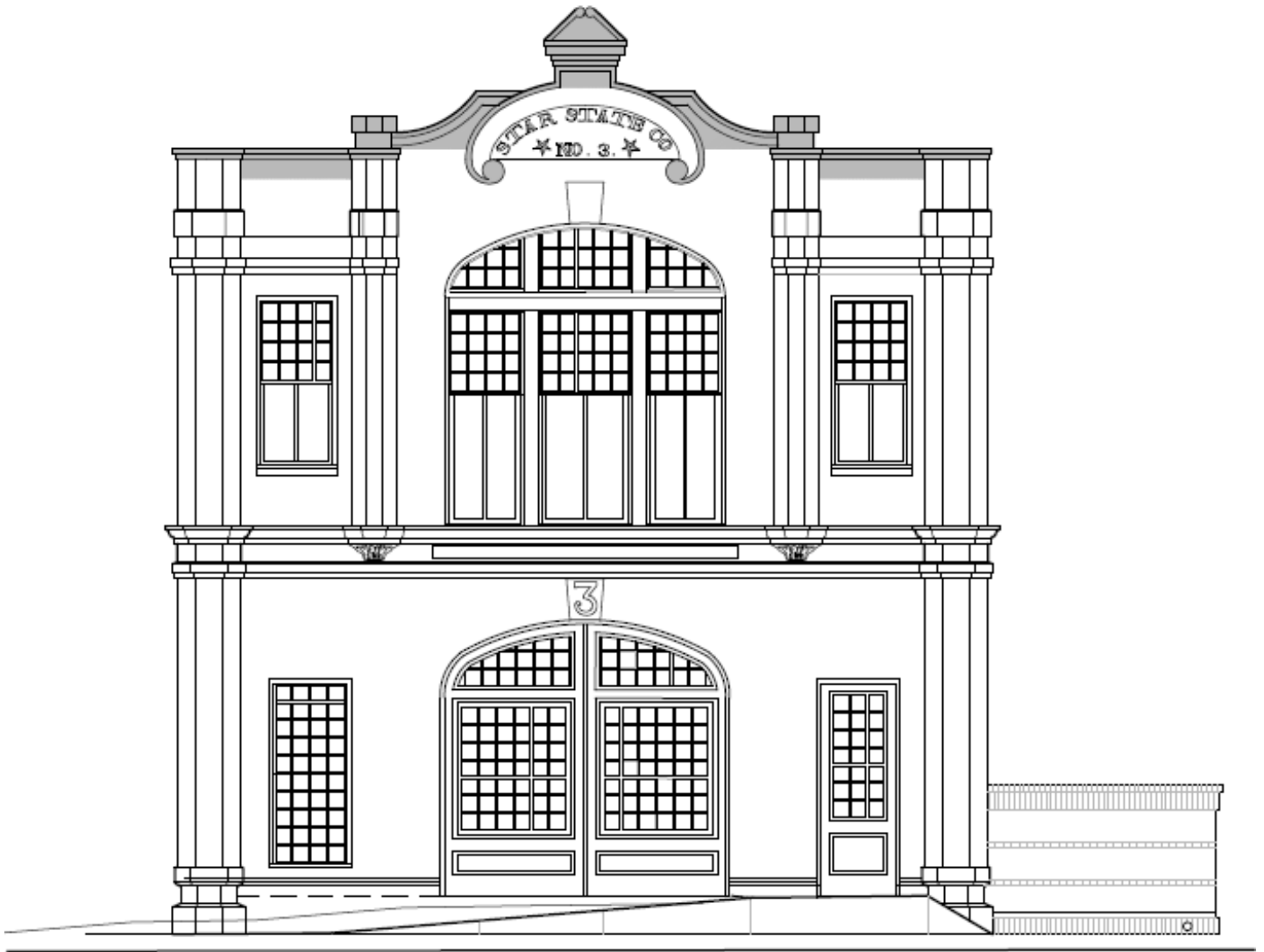

GALVESTON HISTORICAL FOUNDATION

FIREHOUSE NO. 3 DESIGN GUIDELINES

BALCONIES + CANOPIES

APPROPRIATE

ON NORTH FAÇADE ONLY

MOST BE MADE OF METAL

BALCONIES MUST BE LIMITED TO AREAS WITH A DOOR OR WINDOW.

NO TREATED WOOD BALCONY AND STAIRS WILL BE PERMITTED.

HISTORIC BALCONY ON SOUTH FAÇADE

THE ORIGINAL BALCONY MUST BE MAINTAINED IN GOOD CONDITION AND AT ITS CURRENT LOCATION.

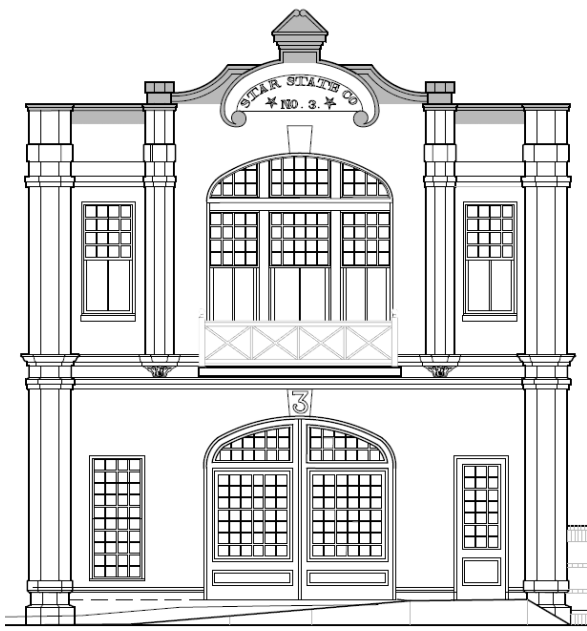

INAPPROPRIATE

BALCONIES WILL NOT BE PERMITTED ON THE WEST OR EAST SIDE ELEVATIONS

NO TREAT WOOD DECK OR STRUCTURES

NO VINYL / PVC POSTS OR RAILINGS

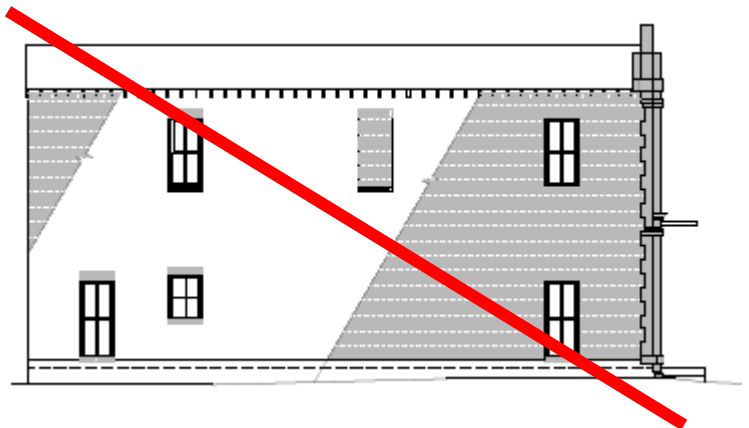
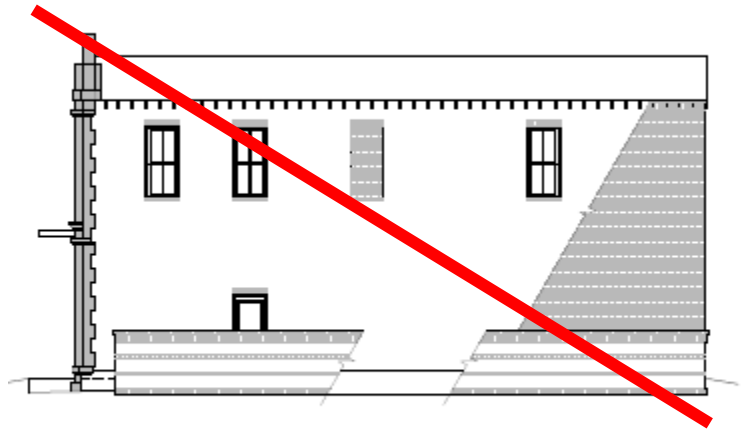

WINDOWS

APPROPRIATE

SOUTH FAÇADE

ALL WINDOWS MUST MAINTAIN THE ORIGINAL LITE CONFIGURATION.

MATERIAL: WOOD WINDOW ONLY

FIRST FLOOR WINDOW

SECOND FLOOR

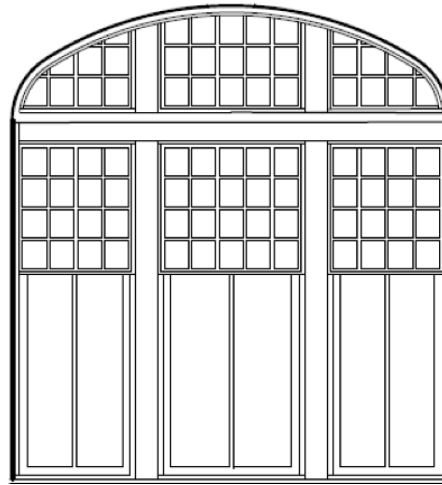
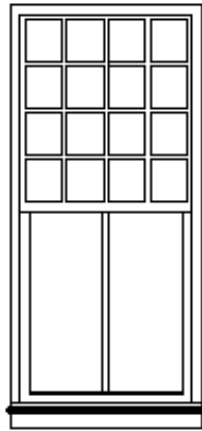
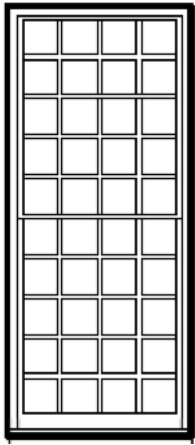

NORTH, EAST, WEST FAÇADE

TYPICAL WINDOW: SINGLE-HUNG 2/2 LITES

NEW OPENINGS IN GHOST WINDOWS APPROPRIATE ON THE WEST AND EAST FAÇADES.

NEW WINDOWS MUST MATCH THE OTHERS.

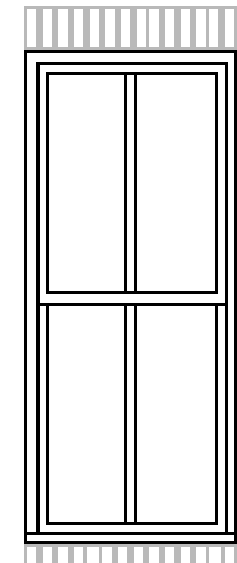
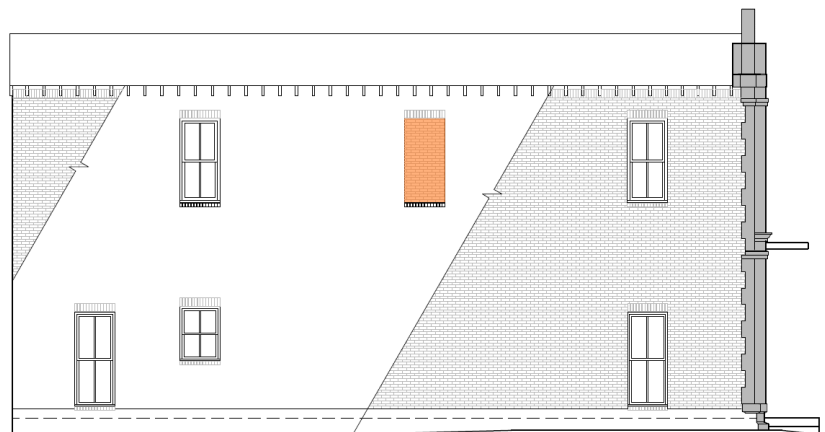
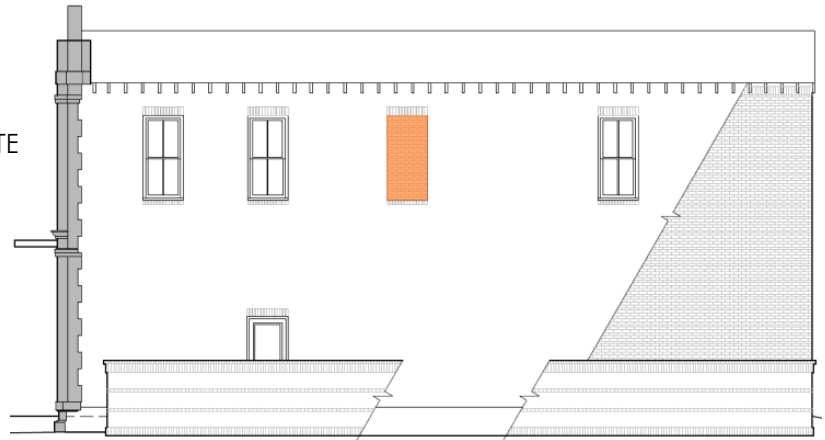

INAPPROPRIATE

NO VINYL OR ALUMINUM WINDOWS

DOORS

APPROPRIATE

SOUTH FAÇADE

THE DOUBLE DOOR OPENING MUST BE MAINTAIN.

THE ORIGINAL LITE CONFIGURATION SHALL BE MAINTAINED AND/OR REPRODUCED.

MATERIAL: WOOD OR METAL WITH GLASS

INAPPROPRIATE

NO VINYL DOORS

NO RESIDENTIAL RAISED PANEL GARAGE DOORS ON THE SOUTH FAÇADE

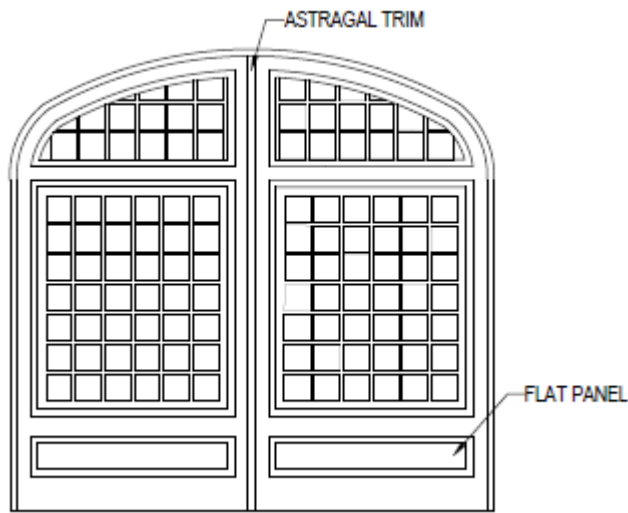

NORTH, EAST, WEST FAÇADE

SIDE ENTRANCES AND REAR ENTRANCES MAY HAVE SOLID, HOLLOW CORE OR METAL DOORS. THEY SHOULD BE PERIOD APPROPRIATE AND MAINTAIN THE OPENING SIZE.

A STEEL OR ALUMINUM ROLLING DOOR OR A TRACK GARAGE DOOR CAN BE INSTALL ON THE NORTH FACADE

EXAMPLES OF APPROPRIATE DOORS:

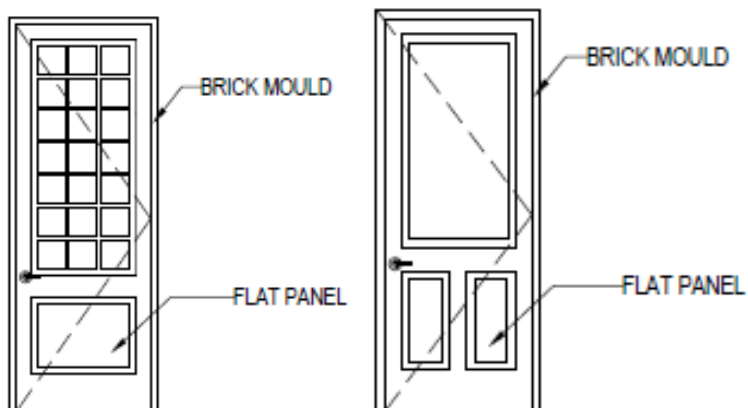

SIGNS

APPROPRIATE

HANGING SIGNS

15 SQ. MAX.*

ATTACHMENT APPROVED BY GHF.

LOCATION OF HANGING SIGN SHALL NOT OBSCURE THE RAISED "3" ON THE MAIN FAÇADE.

MONUMENT SIGN

5' x 8' MAX.*

MATERIALS: MASONRY OR METAL

NO PLASTIC BACK-LITE SIGNS

STUCCO CAN BE PAINTED

EXISTING SIGNS

ALL EXISTING HISTORIC SIGNS MUST BE MAINTAINED IN GOOD CONDITION AND AT ITS CURRENT LOCATION.

THE SUBJECT MARKER LOCATED EAST OF THE FRONT FAÇADE MUST BE MAINTAINED IN GOOD CONDITION. RELOCATION OF THIS SIGN MUST HAVE GHF AND TEXAS HISTORICAL COMMISSION APPROVAL.

INAPPROPRIATE

ROOF TOP SIGN

WALL-MOUNTED SIGNS ON SOUTH FAÇADE

NO PAINTING ON THE BRICK OR THE HISTORIC SIGN.

*SIZE RESTRICTED BY

GHF DEED RESTRICTIONS

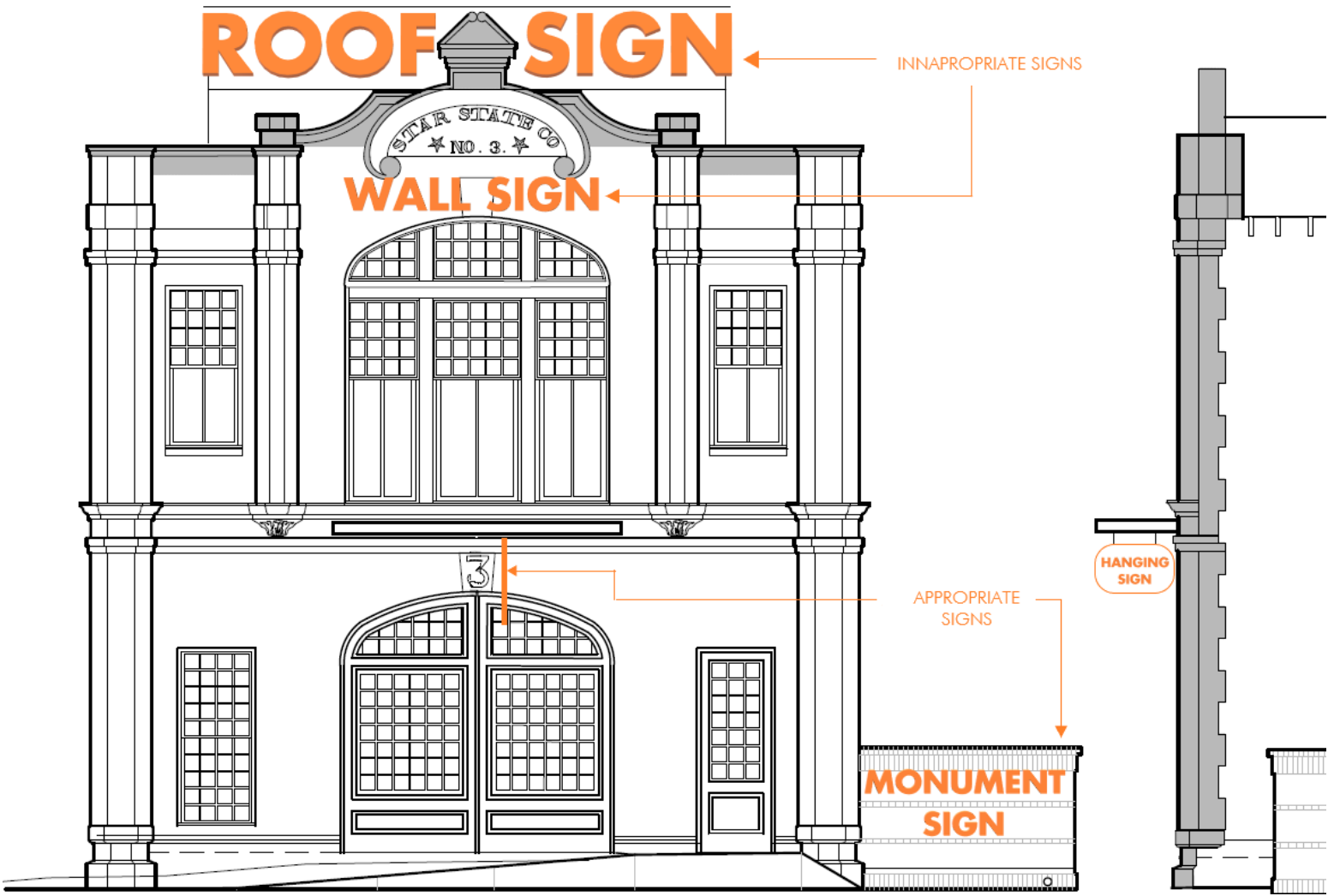

FENCES + WALLS

APPROPRIATE

MASONRY PRIVACY FENCE

ALLOWED ON THE EAST , WEST AND NORTH OF THE PROPERTY. MAX HEIGHT 6'

FENCE OR WALL ACROSS THE SOUTH PROPERTY LINE MUST BE SETBACK A MINIMUM OF 3' FROM THE FRONT FAÇADE

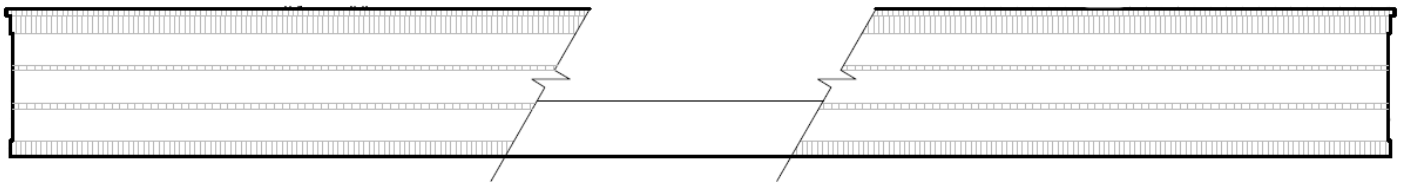

METAL PRIVACY FENCE

ALLOWED ON THE EAST , WEST AND NORTH OF THE PROPERTY. MAX HEIGHT 6'

FENCE OR WALL ACROSS THE SOUTH PROPERTY LINE MUST BE SETBACK A MINIMUM OF 3' FROM THE FRONT FAÇADE

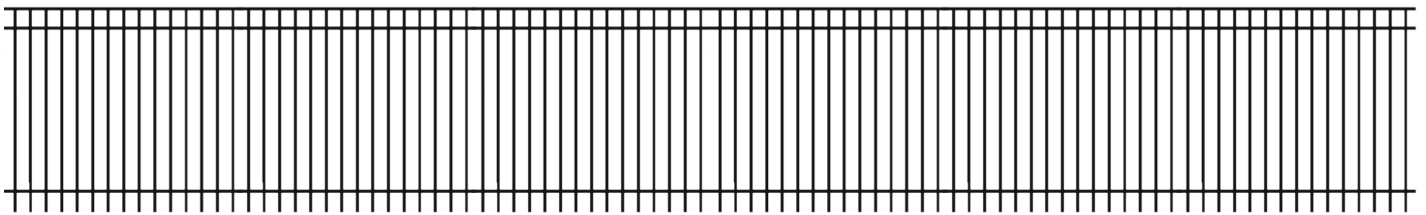

INAPPROPRIATE

WOOD PICKET FENCE

NO VINYL OR PLASTIC MATERIAL

FENCE OR WALL ACROSS THE FRONT FAÇADE

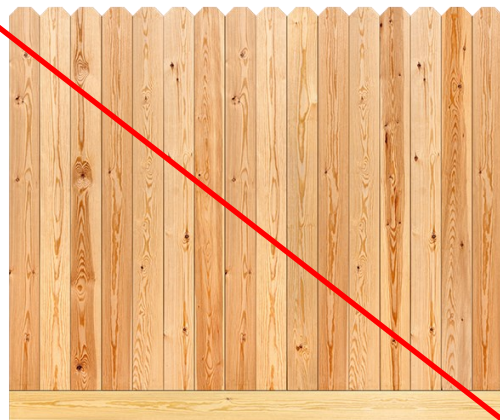

SITE IMPROVEMENTS

APPROPRIATE

RAMPS

LIMITED TO THE EAST & NORTH FAÇADES TO DOORWAY(S).

RAMP MUST BE OF SUBSTANTIAL MATERIAL

HARDSCAPE + LANDSCAPE

LIMITED TO EAST & NORTH FAÇADE

SLOPED ENTRANCE TO THE FRONT DOUBLE DOORS MUST BE RETAINED.

INAPPROPRIATE

RAMPS

WOOD RAMP MATERIAL

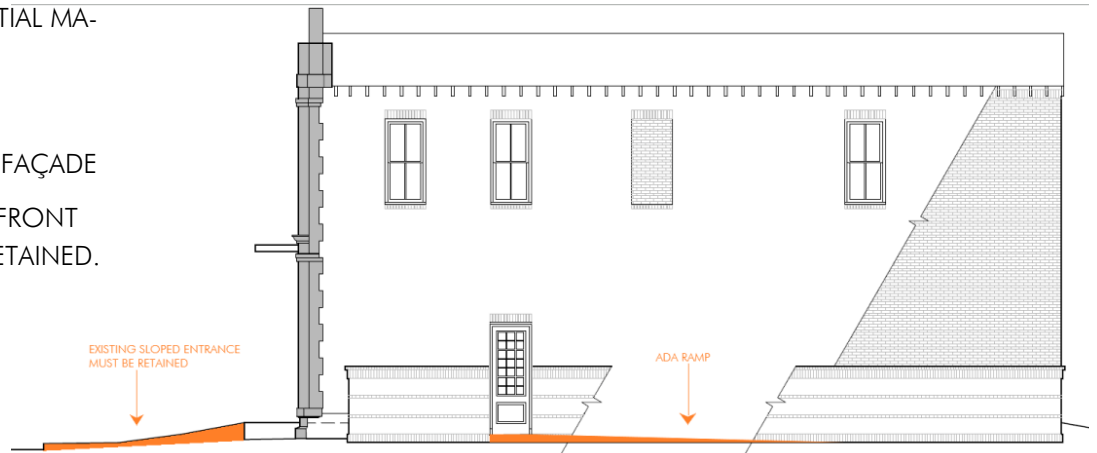

MECHANICAL

APPROPRIATE

ON THE REAR OF THE PROPERTY

OR EAST SIDE YARD

MUST BE SCREENED FROM VIEW WHEN VISIBLE FROM THE RIGHT OF WAY.

INNAPROPRIATE

IN THE SOUTH/FRONT OF THE PROPERTY

ALONG THE WEST ELEVATION

CONDITIONAL

ROOF TOP

MUST BE SCREENED FROM VIEW FROM ALL PUBLIC RIGHT OF WAYS.

REQUIRES LANDMARK APPROVAL

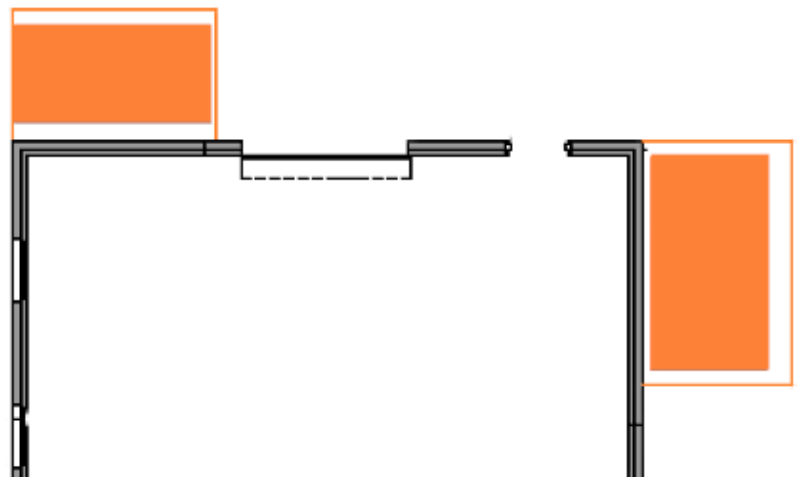

ADDITIONS

APPROPRIATE

REAR ADDITION

LIMITED TO TWO-STORIES MAX.

HEIGHT CANNOT EXCEED ABOVE THE EXISTING
ROOF LINE

REQUIRES LANDMARK APPROVAL

INAPPROPRIATE

ROOF TOP ADDITION

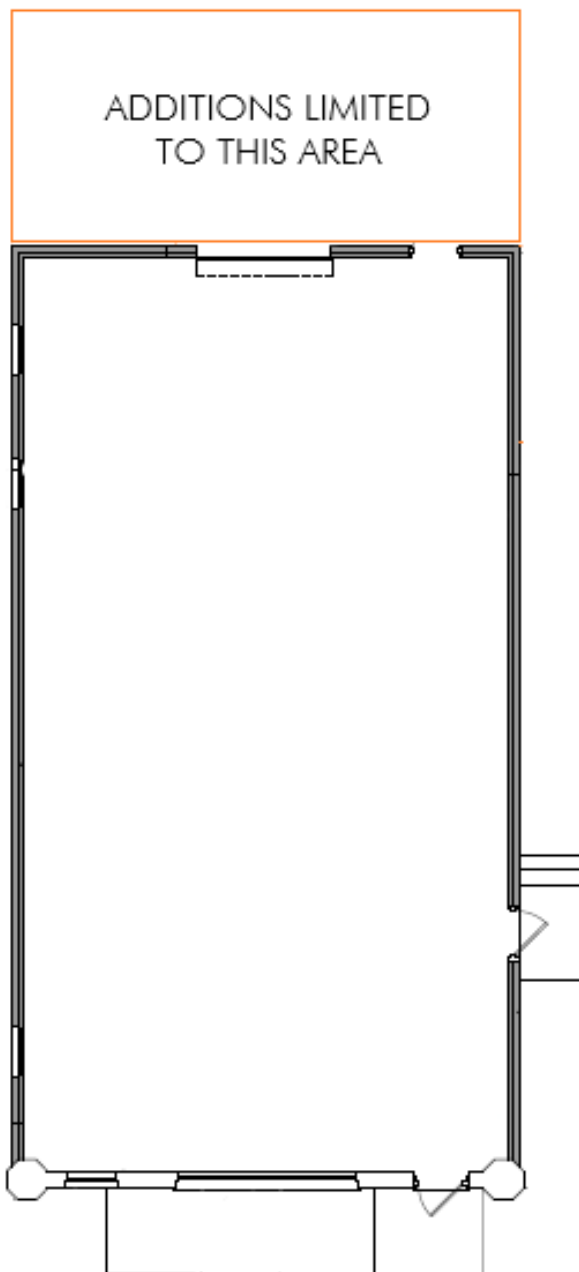

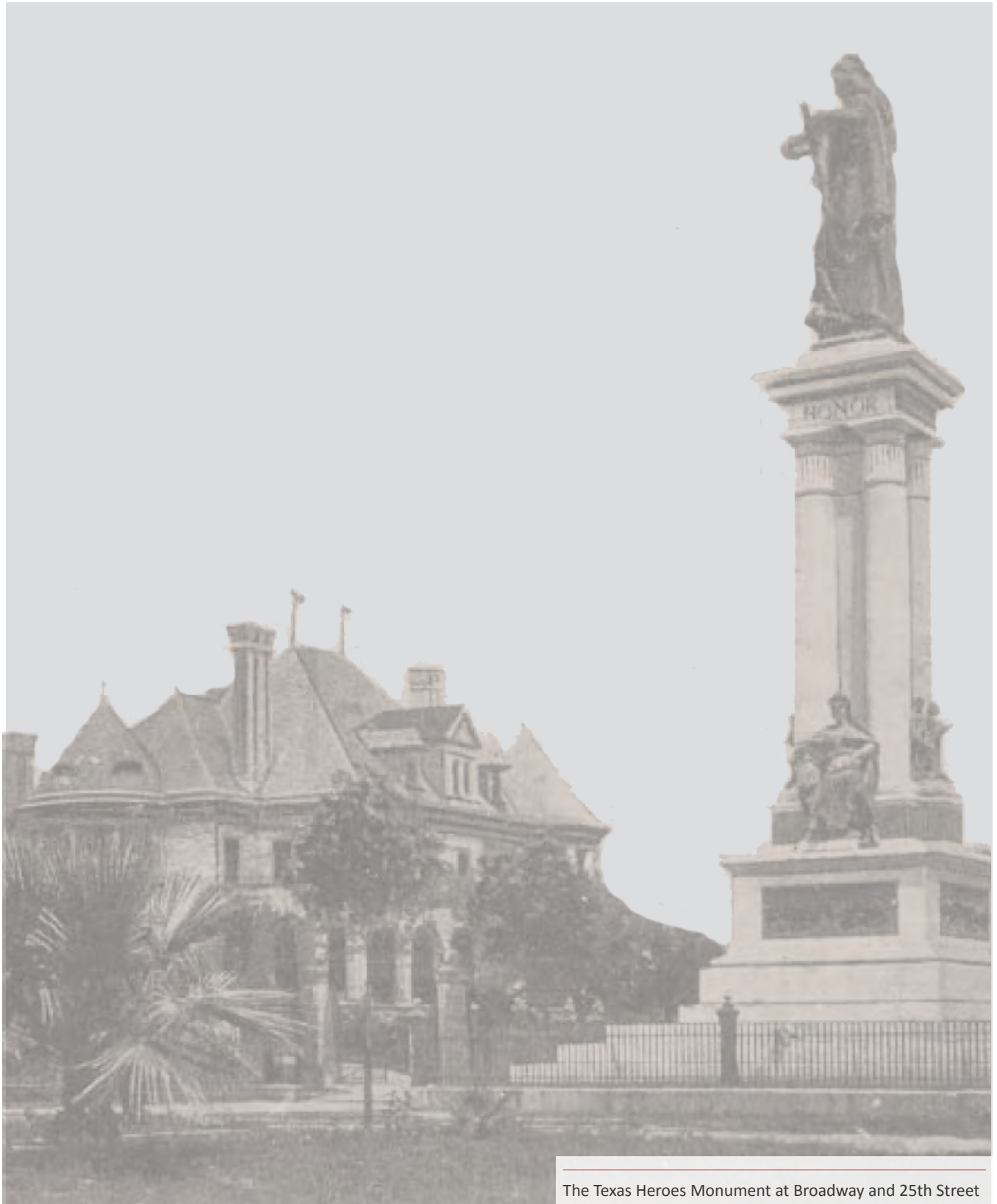

The Texas Heroes Monument at Broadway and 25th Street

APPENDICES

A range of administrative procedures and historic background information supports effective use of the *Design Standards for Historic Properties*.

The appendices provide background information including descriptions of Galveston’s historic architectural styles, a glossary, and listing of relevant resources. They also include information on the administrative process for improvements in historic districts including a permit process flow chart and guidance on how to present a proposed project to the Landmark Commission.



In This Chapter	
Appendix I. Historic Architectural Styles and Types	A-2
Alley House	A-2
Art Deco	A-2
Colonial Revival	A-3
Commissary House/Shotgun Cottage	A-3
Gable Front Cottage	A-4
Double Gallery House	A-5
Exotic Revival.....	A-5
Gable-End Dormered Cottage	A-5
Galveston Vernacular Buildings	A-6
Greek Revival.....	A-6
Italianate.....	A-6
Mission	A-7
Moderne	A-7
Neoclassical/Classical Revival.....	A-7
Prairie.....	A-8
Ranch/Modernist	A-8
Queen Anne.....	A-9
Second Empire	A-9
Spanish Eclectic	A-10
Tudor	A-10

Appendix II. Glossary of Terms	A-11
Secretary of the Interior’s Standards for the Rehabilitation of Historic Properties.....	A-21
Appendix III. Background Resources	A-21
Preservation Resources in Galveston	A-22
State Preservation Resources	A-23
National Preservation Resources	A-23
Preservation-Related Publications	A-23
Appendix IV. Designation and Application Process	A-25
Process for Individual Landmark Designation	A-25
Permitting and Appeals Process	A-26
How to Present to the Landmark Commission.....	A-27

APPENDIX I. HISTORIC ARCHITECTURAL STYLES AND TYPES

Galveston’s historic residential and commercial areas include a variety of historic architectural styles. The *Design Standards for Historic Properties* promote maintenance of Galveston’s historic architectural richness. In many cases, individual design standards indicate that a specific treatment should be compatible with the architectural style of the structure. A number of Galveston’s most common historic architectural styles are summarized below to support review and discussion of appropriate treatment strategies.



Alley houses are small buildings located behind the main house.

Alley House

This vernacular building type is named for its placement on the alleys that run between the east-west Avenues. Alley houses are small buildings located behind the main house. They get their name from their alley orientation and many were built as rental property. The alley house is an important element of the residential historic districts.

Art Deco

The Galveston Cotton Exchange (illustrated below) is an excellent example of the Art Deco style with its symmetrical façades, stylized entries and designs at the cornice level.

Key Features of an Art Deco Building

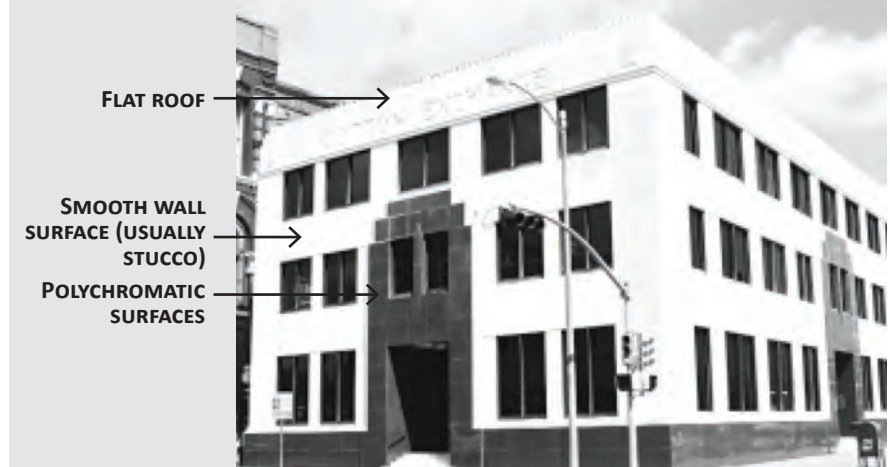

Colonial Revival

The Colonial Revival style was very popular in Galveston from the late 1890s into the 1920s. The style typically includes rectangular floor plans and symmetrical façades and was seen as a relief from the elaborateness of the Queen Anne.

Typical features of the style include Tuscan order porch columns, stick balusters, Palladian windows, six over one (6/1) or one over one (1/1) sash windows and pedimented entry porticoes.

Commissary House/ Shotgun Cottage

Shotgun cottages are small, rectangular houses that are only one room wide, with a door at the front and back. They were the most popular housing style in the Southern United States from the end of the Civil War through the 1920s, and are often associated with rental housing for low-income families. In Galveston, shotgun cottages are often called commissary houses because neighborhood commissaries distributed them to serve as emergency housing following the 1900 Storm.

Most commissary houses in Galveston have three rooms, a hipped or gabled roof, a simple projecting or inset porch and barge board detail. Additions and modifications have been made to most Galveston commissary houses over time, including raised foundations (sometimes by as much as one story to allow an additional floor of living space) and siding modifications.

Key Features of a Colonial Revival Building



The Colonial Revival style was seen as a relief from the elaborateness of the Queen Anne.

Key Features of a Commissary House/ Shotgun Cottage



Key Features of a Gable Front Cottage

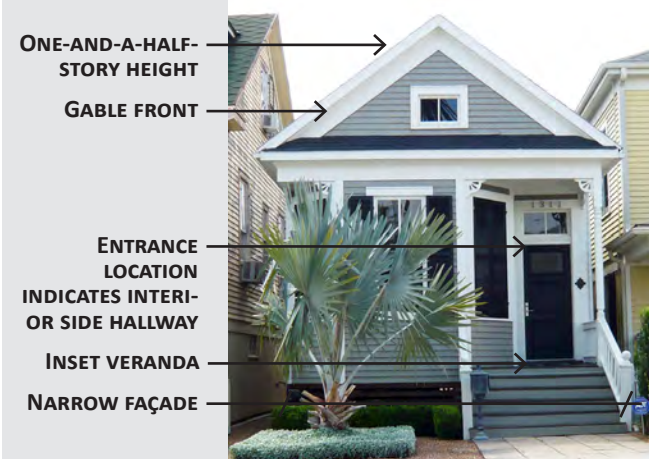

Gable Front Cottage

Gable front cottages are simple one or one-and-a-half-story houses with a street-facing gabled roof. Although narrow, they tend to be wider than commissary houses or shotgun cottages, allowing for a center or side hallway to access individual rooms. The location of the main entrance indicates the interior hallway configuration.

Typical features of a Gable Front Cottage include a perpendicular orientation to the street, and an attached porch or inset veranda.

Key Features of a Craftsman Building



Craftsman

Craftsman, or “bungalow” houses were extensively built from the 1920s into the 1940s, most often in the historic districts and west of 33rd Street. There are many elevated Craftsman examples south of Avenue M that were built after the Great Storm. Character defining features include low-pitched gable roof with wide overhanging eaves with exposed rafter tails; decorative brackets in the eaves, battered columns on masonry bases; and partial or full-width porches.



A low-pitched gable roof with wide overhanging eaves and exposed rafter tails are key features of the Craftsman style

Double Gallery House

The Double Gallery and the Dormered Cottage are the most prevalent residential styles found in Galveston. The Double Gallery refers to the porches on both floors. A bay is the repetitive vertical subdivision of the facade — the door and window openings and corresponding porch posts define each bay in a double gallery house.

Most Double Gallery houses in Galveston are three bays wide. The five bay wide houses are typically larger structures although there are a few examples of five bay cottages.

Exotic Revival

This exuberant classical style was popular from 1885 to 1930 and has many of the same details found in other Renaissance-inspired styles.

Gable-End Dormered Cottage

The Dormered Cottage, also called the Gulf Coast Cottage, is another prolific Galveston vernacular building type. Cottages, as their name implies, are modest one or one-and-a-half-story structures, built of wood on a pier and beam foundation. The Dormered Cottage gets its name from the dormers placed on the roof that adds the additional half-story.

Key Features of a Gable-End Dormered Cottage

DORMER ON ROOF
ADDS ADDITIONAL
HALF-STORY

MODEST ONE OR
ONE-AND-A-HALF
STORY WOOD
STRUCTURE ON A
PIER AND BEAM
FOUNDATION



Key Features of a Double Gallery House

COVERED TWO-
STORY GALLERIES
FRAMED AND
SUPPORTED BY
COLUMNS

ASYMMETRICAL
ARRANGEMENT OF
FAÇADE OPENINGS

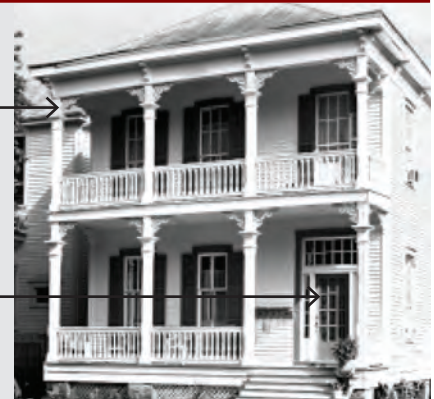

Five-bay Double Gallery Houses are typically larger structures.

Key Features of an Exotic Revival Building

GRAND SIZE AND
SCALE

DECORATIVE COL-
UMNS AND MOTIFS

DELICATE AND
ORNATE TRIM



Key Features of an Greek Revival Building



Galveston Vernacular Buildings

The majority of buildings in Galveston cannot be described as a specific style. Instead, they are best described as “Galveston vernacular” because they represent a local interpretation of a building type or are a mixture of several styles. The following are some of the types that were built in the late 19th and early 20th centuries.

There are many variations within each building type. For example, pick out the dormer cottages in your neighborhood. The details will differ on each cottage but all the cottages will share the same basic characteristics.

Key Features of an Italianate Building

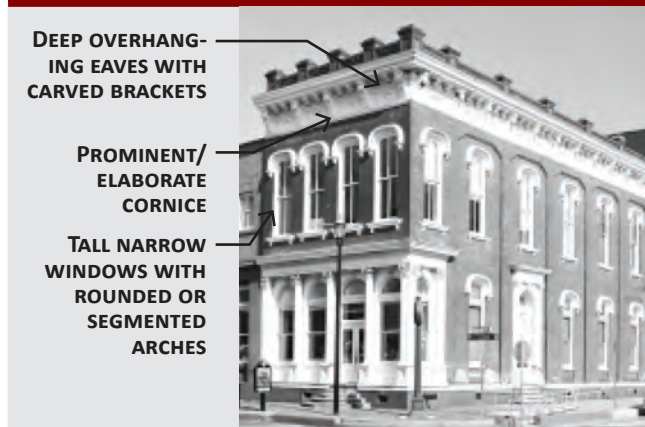

Greek Revival

The Greek Revival was a popular style across the United States from 1825-1860 and typically features a gabled or hipped roof, prominent cornice with wide bands of trim, a frieze, porches supported by prominent square, rounded or fluted columns, a front door surrounded by narrow sidelights and a rectangular line of transom lights above. In Galveston, the style was popular among the earliest buildings in the 1830s and continued with cottages and large houses though the 1870s with a few examples from the 1880s.

Italianate

There are many examples of the Italianate style in Galveston. This style of architecture was popular nationwide from 1840-1885 and in Galveston the style lingered into the 1890s. Italianate houses are typically large — two or three stories — and have low-pitched roofs and wide overhanging eaves with decorative brackets. The windows are typically tall, narrow and arched with heavy molded hoods or lintels. There is heavy use of elaborate and projecting molding on doors and detailing of bay windows.



Italianate houses are typically large.

Mission

The Mission style was popular in the early 1910s in Galveston. The most important Galveston building of this style is the Hotel Galvez, whose opening in 1911 was proof of the city's recovery from the September 8, 1900 hurricane, known locally as the Great Storm. The style originated in California in the 1890s as the Spanish Colonial missions were "rediscovered" in the search for regional styles. Elements of this style include red clay tile roofs that are low-pitched hips; mission parapet on the main entry porch; stucco exterior veneer and wide overhanging eaves.

Moderne

This style is not prolific in Galveston but there are several good examples from the 1930s-1940s. Wall surfaces are smooth, roofs are flat with a small horizontal coping ledge that emphasized the horizontality of the structure, windows typically are metal and the house form is asymmetrical with some rounded corners.

Neoclassical/Classical Revival

Typical features of this style include a symmetrical façade dominated by monumental classical columns with Ionic or Corinthian capitals. Neoclassical buildings in Galveston date from the early 1900s. The style was popular nationwide from 1895 to 1950.



The 1911 Galvez Hotel is the most important example of the Mission style in Galveston.

Key Features of a Mission Style Building

TRADITION-
ALLY SHAPED ROOF
PARAPET

RED TILE ROOF
COVERING

SMOOTH STUCCO
FINISH



Key Features of a Moderne Building

FLAT ROOFS WITH
COPING AT THE
ROOF LINE

LINEAR OR STREAM-
LINED FORMS

USE OF GLASS
BLOCK

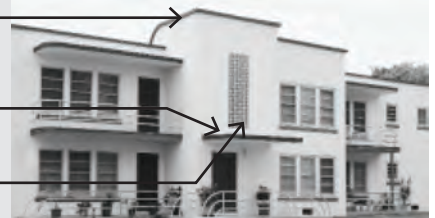

Key Features of a Neoclassical Building

HIPPED ROOF

DENTIL COURSE
UNDER EAVES

LOW PORCH RAILS



Moderne houses are typically asymmetrical with some rounded corners.

Prairie

A few examples of this late 19th and early 20th century style exist in Galveston. It is marked by horizontal lines, flat or hipped roofs, overhanging eaves and windows in horizontal bands.

Ranch/Modernist

The ranch house is a post-World War II housing form found throughout the country. Infill ranch houses were built in Galveston after Hurricane Carla in 1961, where tornados touched down between Avenues O and P just east of 23rd Street. They are also seen in the East End and Lindale Park. The typical ranch house has a low-pitched roof, a slab-on-grade foundation, aluminum windows and an 8' interior ceiling height.

Modernist is a sub-style of the ranch form, and was a favorite for architect-designed houses from about 1950-1970. Typical features of the style include a flat roof, recessed entryways, interior light courts, attached carports and minimal detailing.

Key Features of a Prairie-Style House

- FLAT OR LOW HIPPED ROOF
- OVERHANGING EAVES
- HORIZONTAL ROWS OF WINDOWS
- HORIZONTAL LINES



Key Features of a Ranch-Style House

- LONG, LOW ROOFLINE
- LARGE OVERHANGING EAVES
- MINIMAL USE OF EXTERIOR DECORATION
- SLAB ON GRADE FOUNDATION



Key Features of a Modernist-Style House

- FLAT ROOF
- LARGE EXPANSES OF GLASS
- MINIMAL DETAILING



Queen Anne

This Victorian-era style is characterized by a diverse collection of volumes and textures. Key features include asymmetrical façades, decorative shingles and/or brickwork, wrap around porches, and intersecting gable or hipped roofs. Some structures have turrets and stained glass. High-style Queen Anne was popular in Galveston in the 1880s and 1890s and continued in a scaled-down version into the early 20th-century.

Second Empire

The 1870 Merchants Mutual Insurance Company building (illustrated below) is a good example of the Second Empire style that was popular in the late 19th century. Key features include mansard roofs, classical detailing, and decorative window hoods and sills.

Key Features of a Queen Anne House

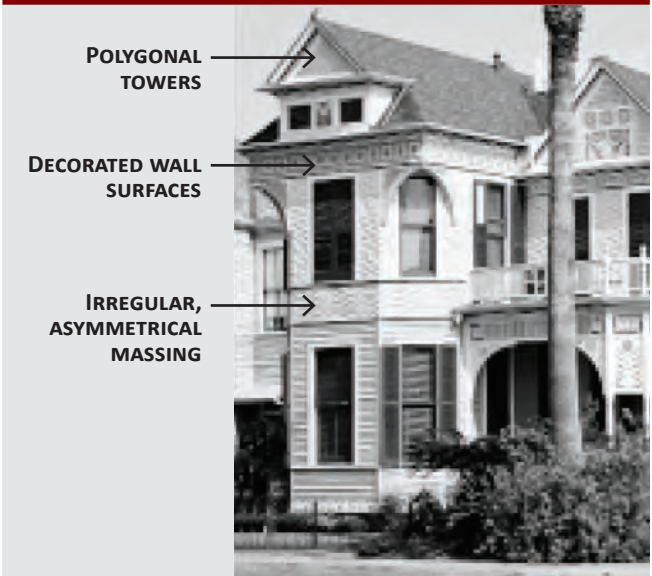

Key Features of a Second Empire Style Building



Key Features of a Spanish Eclectic House



Spanish Eclectic

The Spanish Eclectic style is similar to the Mission style but without the pronounced Mission parapet. The style was a popular residential style in Galveston in the 1920s.

Tudor

Numerous Tudor houses can be found along Avenue O, west of 45th Street and throughout Denver Court. The style, was popular nationwide from 1890 to 1940, but most Galveston examples are from the 1920s and 1930s. Character-defining features include steeply pitched roofs (usually a side gable), decorative half-timbering, tall narrow windows, arched doors and decorative brickwork on chimneys.

Key Features of a Tudor House

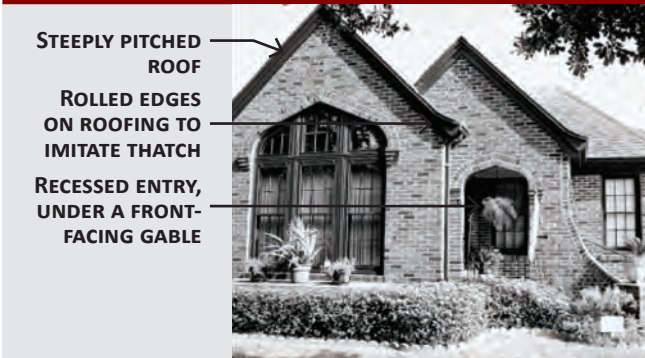

APPENDIX II. GLOSSARY OF TERMS

A number of architecture, design and preservation-related terms that support use of the *Design Standards for Historic Properties* are defined below.

Adaptive Use. Rehabilitation of a historic structure for use other than its original use, such as a residence converted into an office. The exterior appearance of the structure should generally not be significantly altered.

Addition. New construction added to an existing building or structure.

Alteration. Any material construction or change to the exterior of a building, object, site or structure, including, but not limited to, changing to a different type, style or size of roofing or siding materials; changing, eliminating or adding doors, door frames, windows, window frames, shutters, fences, railings, columns, beams, walls, steps, porches, balconies, signs or other ornamentation; and, dismantling, removing or moving any exterior features or demolition. Alteration does not include ordinary repair and maintenance. Changing paint color in the Strand/Mechanic Historic District could be an alteration.

American Bond. A brickwork pattern where most courses are laid flat, with the long ‘stretcher’ edge exposed, but every fifth to eight course is laid perpendicularly, with the small ‘header’ end exposed.

Appropriate. Suitable or compatible.

Appurtenance. Any accessory or subordinate building, object, structure, fence, street furniture, fixture, vending machine, fountain, public artwork, or bicycle rack located on the grounds of a historic building or in a historic district.

Arch. A curved construction that spans an opening and supports the weight above it. (See flat arch, jack arch, segmental arch and semi-circular arch)

Archaeology. The science or study of the material remains of past life activities and the physical site, location or context in which they are found, as delineated in the Department of the Interior’s Archaeological Resources Protection Act of 1979.

Area. A specific geographic division of the City of Galveston.

Attic. The upper level of a building, usually not of full ceiling height, directly beneath the roof.

Awning Sign. Any signs painted on, attached to, or constructed on an awning or the valance thereof.

Baluster. One of a series of short vertical members used to support a stair or porch handrail, forming a balustrade.

Balustrade. An entire rail system, with top rail and balusters.

Bargeboard. A board which hangs from the projecting end of a gable roof, covering the end rafters, and often sawn into a decorative pattern. Also called vergeboard.

Bay. The portion of a façade between columns or piers providing regular division usually marked by windows.

Bay window. A projecting window that forms an extension to the floor space of the internal room.

Belt Course. A horizontal band usually marking the floor levels on the exterior façade of a building.

Block Face. See street face.

Board & Batten. Siding fashioned of boards set vertically and covered where their edges join by narrow strips called battens.

Bond. A term used to describe the various patterns in which brick (or stone) is laid, such as ‘common bond’ or ‘Flemish bond.’

Bracket. A projecting element of wood, stone or metal which spans between horizontal and vertical surfaces (eaves, shelves, overhangs) as decorative support.

Building. A structure created to shelter people or things, such as a house, barn, church, hotel, warehouse or similar structure.

Bulkhead. The structural panels just below display windows on storefronts. Bulkheads can be both supportive and decorative in design. Bulkheads from the 19th-century are often of wood construction, with rectangular raised panels, while those of the 20th century may be of wood, brick, tile or marble construction. Bulkheads are also referred to as kick plates.

Canopy. A roofed structure placed so as to extend outward from a building, to provide a protective shield for doors, windows, and other openings. Canopies are usually supported by the building with additional support extending to the ground directly under the canopy edge.

Canopy Sign. A sign painted on, attached to, or constructed on a canopy. Those signs suspended beneath the canopy and perpendicular to the building façade are also referred to as ‘UNDER CANOPY SIGNS.’

Capital. The head or top of a column or pilaster.

Casement Window. A window with one or two sashes which are hinged at the sides and usually open outward.

Certificate of Appropriateness (COA). A certificate required by Section 29-80 or by a historic district ordinance for alterations to a structure or new construction in a historic district.

Certified Local Government (CLG). Recognized by the State Historic Preservation Office (SHPO) under regulations noted in the National Historic Preservation Act of 1966, as amended in 1980.

Character. The qualities and attributes of any structure, site, street or district.

Clapboards. Horizontal wooden boards, thinner at the top edge, which are overlapped to provide a weatherproof exterior wall surface.

Classical Order. Derived from Greek and Roman architecture, a column with its base, shaft, capital and entablature having standardized details and proportions, according to one of the five canonized modes: Doric, Tuscan, Ionic, Corinthian or Composite.

Clipped Gable. A gable roof where the ends of the ridge are terminated in small, diagonal roof surface.

Colonial Revival. A house style of the 20th century based on interpretations of architectural forms of the American colonies prior to the revolution.

Column. A circular or square vertical structural member.

Commission. Landmark Commission of the City of Galveston (for this document).

Compatible. Existing or performing in harmonious, agreeable combination with its surroundings.

Compatible Property. A resource in a historic district distinguished by its scale, material, and composition so that it contributes to or is ‘compatible’ with the character of the neighborhood.

Composite. One of the five classical orders. A Roman elaboration of the Corinthian order, having the acanthus leaves of its capital combined with the large volutes of the Ionic order, and other detail also elaborated.

Configuration. The arrangement of elements and details on a building or structure that help to define the character.

Construction. The act of adding an addition to an existing building or structure, or the erection of a new principle or accessory building or structure on a lot or property.

Contemporary. Reflecting characteristics of the current period. Contemporary denotes characteristics that illustrate that a building, structure, or detail was constructed in the present or recent past, rather than being imitative or reflective of a historic design.

Contributing Property. A resource in a historic district that contributes to the district's historical significance through location, design setting, materials, workmanship, feeling and association, and which shall be afforded the same consideration as historic structures or buildings.

Context. The setting in which a historic element, site, structure, street or district exists.

Corbel. In masonry, a projection, or one of a series of projections, each stepped progressively farther forward with height and articulating a cornice or supporting an overhanging member.

Corinthian Order. The slenderest and most ornate of the three Greek orders, characterized by a bell-shaped capital with volutes and two rows of acanthus leaves, and with an elaborate cornice.

Cornice. The uppermost projecting part of an entablature.

Cresting. A decorated ornamental finish along the top of a wall or roof — often made of ornamental metal.

Cross-Gable. A secondary gable roof that meets the primary roof at right angles.

Cultural Resources. Those resources which possess qualities of significance in American, Texas or Galveston history, architecture, archaeology, and cultural presence in districts, sites, structures, and objects that possess integrity of location design, setting, materials, workmanship, congruency and association.

Demolition. Any act or process that destroys or razes in whole, or in part, a building, object, site or structure, including the permanent impairment of structural integrity. This includes demolition by neglect, which is defined as inaction or series of inactions that result in the destruction or irredeemable deterioration of a landmark building.

Dentils. A row of small tooth-like blocks in a classical cornice.

Design Standards. Standards set forth in City ordinance, which preserve the historical, cultural and architectural character of an area, or of a building, object, site or structure.

District. A designated section of the City of Galveston, for which the City may regulate the erection, construction, reconstruction, alteration, repair, or use of a building, other structures or land.

Doric Order. The column and entablature developed by the Dorian Greeks, sturdy in proportion, with a simple cushion capital, a frieze of triglyphs and metopes, and mutules in the cornice.

Dormer Window. A window that projects from a roof.

Double-Hung Window. A window with two sashes, one sliding vertically over the other.

Eave. The edge of a roof that projects beyond the face of a wall.

Effect, Adverse. A negative change in the quality of the historical, architectural, archaeological, or cultural significance of a resource, or in the characteristics that qualify the resource as historically important.

Element. A material part or detail of a site, structure, street, or district.

Elevation. Any one of the external face or façades of a building.

Ell. The rear wing of a house, generally one room wide and running perpendicular to the principal building.

Engaged Column. A round column attached to a wall.

Entablature. A part of a building of classical order resting on the column capital; consists of an architrave, frieze and cornice.

Fabric. The physical material of a building, structure, or community, an interweaving of component parts.

Façade. The face of a building along a street frontage, usually the principal front. Corner buildings may have more than one principal façade.

Fanlight. A semi-circular window usually over a door with radiating muntins suggesting a fan.

Fascia. A flat horizontal member of molding; forms the trim of a flat roof or pitched roof; also part of a classical entablature.

Fenestration. The arrangement of windows on a building.

Finial. A projecting decorative element, usually of metal, at the top of a roof turret or gable.

Fish Scale Shingles. A decorative pattern of wall shingles composed of staggered horizontal rows of wooden shingles with half-round ends.

Flashing. Thin metal sheets used to prevent moisture infiltration at joints of roof planes and between the roof and vertical surfaces.

Flat Arch. An arch set in a straight line; also call a jack arch.

Flemish Bond. A brick-work pattern where the long ‘stretcher’ edge of the brick is alternated with the small ‘header’ end for decorative as well as structural effectiveness.

Fluting. Shallow concave grooves running vertically on the shaft of a column, pilaster or other surface.

Foundation. The lowest exposed portion of the building wall, which supports the structure above.

Form. The shape and structure of a building.

Freestanding (Pole) Sign. Any sign which is wholly supported by one or more columns, uprights, or braces in the ground and has no support to a building, canopy or façade.

Frieze. The middle portion of a classical cornice; also applied decorative elements on an entablature or parapet wall. A broad decorative band below a cornice.

Gable. The triangular section of a wall to carry a pitched roof.

Gable Roof. A pitched roof with one downward slope on either side of a central, horizontal ridge.

Gambrel Roof. A ridged roof with two slopes on either side.

Galveston Landmark. (I) Any individual building, structure or object, or site that the Commission designates, upon the owner's request, as a Galveston Landmark; or, (II) any individual building, structure or object, or site that is located within a designated historic zoning district.

Galveston Landmark Commission. The body appointed by the City Council to administer and guide the preservation, protection, reconstruction, and rehabilitation of places of historic and cultural significance in the City of Galveston, as they may be designated by classification in the Historical District, or as they may be designated in accordance with Section 29-80 of the 'Zoning Standards 1991' as it exist now or may be amended. The terms 'Historic District Board' or 'Strand/Mechanic Review Board,' as used in the 'Zoning Standards 1991,' shall mean the 'Galveston Landmark Commission.'

Ghost. Outlines or profiles of missing buildings or building details. These outlines may be visible through stains, paint, weathering, or other residue on a building's façade.

Greek Revival. Mid 19th-century revival of forms and ornament of ancient Greece architecture.

Harmony. Pleasing or congruent arrangement.

Height. The distance from the bottom to the top of a building structure.

Hipped Roof. A roof with uniform slopes on all four sides.

Historic District. An area designated as a 'historic district' by ordinance of the City Council and which may contain, within definable geographic boundaries, one or more landmarks, and which may have within its boundaries other proportions or structures that, while not of such historic or architectural significance to be designated as landmarks, nevertheless contribute to the overall historic or architectural characteristics of the historic district.

Historic Imitation. New construction or rehabilitation where elements or components mimic an architectural style, but are not of the same historic period as the existing buildings (historic replica).

Hood Molding. A projecting molding above an arch, doorway, or window, originally designed to direct water away from the opening. Also called a drip mold or simply a 'hood.'

Historic Property. A district, site, building, structure, or object significant in local, state or national history, architecture, engineering, archaeology or culture.

Infill. New construction where there had been vacant land before, such as a new building between two older structures.

Integrity. The authenticity of a property's historic identity evidenced by the survival of physical characteristics.

In-kind. The replacement of an element with a new element of the same material, color, texture, shape and form as the original.

Ionic. The classical order of architecture, originated by the Ionian Greeks, characterized by its capital with large volutes, an entablature, continuous frieze, usually dentils in the cornice, and by its elegant detailing, less heavy than the Doric and less elaborate than the Corinthian.

Intrusion. A building, object, site or structure which detracts from a district's historical significance because of its incompatibility with the district's sense of time, place and historical development; or its incompatibility of scale, materials, texture, or color; or whose integrity has been irretrievably lost; or whose physical deterioration or damage makes it unfeasible to rehabilitate.

Inventory. A systematic listing of cultural, historical or architectural resources prepared by a city, state or federal government, or a recognized local historic authority, following standards set forth by federal, state or city regulations for evaluation of cultural properties.

Ionic Order. One of the three Greek Classical orders used to describe decorative scroll capitals.

Jack Arch. An arch set in a straight line; also called a flat arch.

Keystone. The wedge-shaped top or center member of an arch.

Knee Brace. An oversized bracket supporting a roof or porch eave.

Knee Wall. A small curb-like wall often found in residential front yards.

Landmark. A property, structure or natural object designated as a 'landmark' by ordinance of the City Council, pursuant to procedures prescribed in this title, that is worthy of rehabilitation, restoration and preservation because of its historic or architectural significance to the city.

Landscape. The totality of the built or human influenced habitat experienced at any one place. Dominant features are topography, plant cover, buildings or other structures and their patterns.

Lattice. An openwork grill of interlacing wood strips used as screening.

Lintel. The horizontal top member of a window, door or other opening.

Maintain. To keep in an existing state of preservation or repair.

Mansard Roof. A roof with a double slope on all four sides, with the lower slope being almost vertical and the upper almost horizontal.

Masonry. Exterior wall construction of brick, stone or adobe, laid up in small units.

Massing. The overall composition of the exterior of the major volumes of a building, especially when the structure has major and minor elements.

Material Change. A change that will affect either the exterior, architectural or environmental features of a historic property or any structure, site or work of art within a historic district.

Materials. The physical elements that were combined or deposited in a particular pattern or configuration to form a historic property.

Metal Standing Seam Roof. A roof composed of overlapping sections of metal such as copper-bearing steel or iron coated with terne alloy of lead and tin. These roofs were attached or crimped together in various raised seams for which the roof is named.

Modillion. A horizontal bracket, often in the form of a plain block, ornamenting the underside of a cornice.

Mortar. A mixture of sand, lime, cement and water, used as a binding agent in masonry construction.

Multi-Light Window. A window sash composed of more than one pane of glass.

Mutule. One of a series of broad, low, rectangular blocks supporting a classical style cornice.

Muntin. A secondary framing member to divide and hold the panes of glass in a multi-light window or glass door.

New Construction. Construction which is characterized by the introduction of new elements, sites, buildings or structures or additions to existing buildings and structures in historic areas and districts.

Non-Contributing. A building, object, site or structure which neither adds to, nor detracts from, a district's sense of time and place and historical development.

Non-Façade. The face of a building other than on a street frontage; non-principal front.

Normally Required. Mandatory actions, summarized in the Design Standards, whose compliance is enforced by the Landmark Commission.

Object. A material thing of functional, aesthetic, cultural or historical value that may be, by nature or design, moveable, yet related to a specific setting or environment.

Obscured. Covered, concealed or hidden from view.

Ordinary Repair and Maintenance. Any work, the purpose and effect of which, is to correct any deterioration, decay, or damage to a building, object or structure, or any part thereof, and to restore the same, as nearly as may be practicable, to its condition prior to such deterioration, decay or damage, using the same materials, or those materials available which are as close as possible to the original. In-kind replacement, or repair, is included in this definition.

Oriel Window. A bay window that emerges above the ground floor level.

Orientation. The relationship of a structure to the compass points or a site feature; may refer to the direction a façade faces, such as the south elevation, or the direction of a main axis, as in an east-west orientation.

Overlay Zone. A set of zoning requirements that is described in ordinance text, is mapped and is imposed in addition to those of the underlying district. Development within the overlay zone must conform to the requirements of both zones, or the more restrictive of the two.

Paired Columns. Two columns supported by one pier, as on a porch.

Palladian Window. A window with three openings, the central one arched and wider than the flanking ones.

Paneled Door. A door composed of solid panels (either raised or recessed), held within a framework of rails and stiles.

Parapet. A low horizontal wall at the edge of a roof, porch or terrace.

Pediment. A triangular crowning element forming the gable of a roof; any similar triangular element used over windows, doors, etc.

Pier. A vertical structural element, square or rectangular in cross-section.

Pilaster. A square pillar attached, but projecting from a wall, resembling a classical column.

Pitch. The degree of the slope of a roof.

Portico. A roofed space, open or partly enclosed, forming the entrance and centerpiece of the façade of a building, often with a column and pediment.

Portland Cement. Strong, inflexible hydraulic cement used to bind mortar. Mortar or patching materials with a high Portland cement content should not be used on pre-1920 buildings. The Portland cement is harder than the masonry, thereby causing serious damage over annual freeze-thaw cycles.

Primary façade. The main building face; the side of a building that faces the street.

Preservation. The act or process of applying measures to sustain the existing form, integrity and material of a building or a structure, including, but not limited to, initial stabilization work and on-going maintenance of historic building materials and the existing form and vegetative cover of a site.

Pressed Tin. Decorative and functional metalwork made of molded tin used to sheath roofs, bays and cornices.

Projecting Sign. Any sign other than a wall sign, flat sign, or roof sign, or under canopy sign, which projects more than 18-inches from the face of an exterior building wall or façade, and which uses the building wall as its primary source of support.

Proportion. The relationship of the size, shape, and location of one building element to all the other elements; each architectural style typically has its own rules of proportion.

Pyramidal Roof. A roof with four identical sides rising steeply to a central peak.

Queen Anne. A popular late 19th-century revival style of early 18th-century English architecture, characterized by irregularity of plan, massing, and a variety of texture.

Quoins. A series of stone, bricks, or wood panels ornamenting the outside of a wall.

Recommended. Suggested, but not mandatory actions summarized in the Design Standards.

Reconstruction. The act or process of reassembling, reproducing or replacing by new construction, the form, detail and appearance of the property and its setting as it appeared at a particular period of time by means of the removal of later work, or by the replacement of missing earlier work, or by reuse of the original materials.

Rehabilitation. The act or process of returning a building, object, site or structure to a state of utility through repair, remodeling, or alteration, that makes possible an efficient contemporary use while preserving those portions or features of the building, object, site or structure, that are significant to its historical architectural and cultural value.

Relocation. Any change of the location of a building, object or structure in its present setting or to another setting.

Replication. Constructing a building so that it is an exact replica or imitation of a historic architectural style or period.

Resident Property Owner. A person whose homestead is located in a locally zoned historic district.

Resource. A source or collection of buildings, objects, sites, structures, or areas that exemplify the cultural, social, economic, political or architectural history of the nation, state or city.

Restoration. The act or process of accurately recovering the form and details of a building, object, site or structure, and its setting as it appeared at a particular period of time by means of the removal of later work, or by the replacements of missing earlier work.

Retain. To keep secure and intact. In the Design Standards, 'retain' and 'maintain' describe the act of keeping an element, detail or structure, and continuing the same level of repair to aid in the preservation of elements, sites and structures.

Re-Use. To use again. An element, detail or structure might be reused in historic districts.

Rhythm. Regular occurrence of elements or features, such as spacing between buildings.

Ridge. The top horizontal member of a roof where the sloping surfaces meet.

Roof Sign. A sign mounted upon or above a roof or parapet of a building or structure, which is wholly or partially supported by said building or structure.

Rusticated. Roughening of stonework or concrete blocks to give greater articulation to each block.

Sash. The movable framework containing the glass in a window.

Sandwich Board Sign. Any freestanding 'A-frame' type sign supported by the ground, which may or may not be attached to the ground or other objects.

Segmental Arch. An arch whose profile or radius is less than semicircle.

Setting. The sum of attributes of a locality, neighborhood or property that defines its character.

Scale. Proportional elements that demonstrate the size, materials and style of buildings. The proportions of the elements of a building to one another and the whole, and to adjacent buildings.

Sheathing. An exterior covering of boards or other surface applied to the frame of the structure. (See Siding)

Shed Roof. A gently pitched, almost flat roof, with only one slope.

Shingle Style. Architectural style of the late 19th century, which features frame dwellings largely covered with wood shingles on both floors.

Shingles. Wood which is split into flat panels and different shapes. Wood shingles are common elements of the Queen Anne style.

Sidelight. A vertical area of fixed glass on either side of a door or window.

Siding. The exterior wall covering or sheathing of a structure.

Significant. Having particularly important associations within the context of architecture, history and culture.

Sill. The bottom crosspiece of a window frame.

Site. The location of a significant event, a pre-historic or historic occupation or activity, or a building or structure, whether standing, ruined or vanished, where the location itself maintains historical or architectural value regardless of the value of any existing structure.

Siting. The placement of a building, structure, or object on a site in relation to natural features, boundaries, and other parts of the built environment.

Slate. A type of stone that was used as a roof surface material for pre- 1945 dwellings.

Spindles. Slender, elaborately turned wood dowels or rods often used in screens and porch trim.

Stabilization. The act or process of applying measures essential to the maintenance of a deteriorated building to establish structural stability and a weather resistant enclosure.

Street Face. That portion of a block with frontage on a street; there are generally two block faces with frontage on a street.

Street Level Sign. Signs which are oriented principally to the pedestrian, and which are: located below the roof level of a one story building; located below the second floor of a multi-story building; or, attached to or below a canopy or awning.

Streetscape. The distinguishing character of a particular street as created by its width, degree of curvature, paving materials, design of the street furniture, and forms of surrounding buildings.

Stretcher Bond. A brickwork pattern where courses are laid flat with the long 'stretcher' edge expose.

Structure. A non-moveable work made up of interdependent and interrelated parts and a definite pattern of organization.

Style. A type of architecture distinguished by special characteristics of structure and ornament and often related in time; also a general quality of a distinctive manner.

Surround. An encircling border or decorative frame, usually at windows or doors.

Swag. Carved ornament on the form of a cloth draped over supports, or in the form of a garland of fruits and flowers.

Thematic Group. A finite group of resources related to one another in a clearly distinguishable way, by association with a single historic person, event or developmental force, as one building type or use, as designed by a single architect, as a single archaeological site form, or as a particular set of archaeological research.

Transom. A horizontal window opening over a door or window.

Trim. The decorative framing of openings and other features on a façade.

Turret. A small slender tower.

Tuscan. A simplified version of the Roman Doric order, having a plain frieze and no mutules in the cornice.

Unreasonable Economic Hardship. An economic burden imposed upon an owner, which is unduly excessive and prevents a realization of a reasonable rate of return on the value of its property. The test for determining the existence of an unreasonable economic hardship shall be in accordance with applicable law.

Unusual and Compelling Circumstances. Those uncommon and extremely rare instances, factually detailed, which would warrant the Landmark Commission's review, due to the evidence presented.

Veranda. A covered porch or balcony on a building's exterior.

Vergeboard. The vertical face board following and set under the roof edge of a gable, sometimes decorated by carving. Also called bargeboard.

Vernacular. A regional form or adaptation of an architectural style.

Wall Dormer. Dormer created by the upward extension of a wall and a breaking of the roofline.

Wall Sign. Any sign that is attached to or painted on the outside face of a building. A wall sign is also erected parallel to the face of the building, supported by the building and does not extend more than 18-inches from the face of the building wall or above the roof lines of the building, to which the sign is affixed.

Water Table. A projecting horizontal ledge, intended to prevent water from running down the face of a wall's lower section.

Weatherboard. Wood siding consisting of overlapping boards usually thicker at one edge than the other.

APPENDIX III. BACKGROUND RESOURCES

Background resources to support use of the *Design Standards for Historic Properties* are provided below. They include the Secretary of the Interior's Standards for the Rehabilitation of Historic Properties and a listing of local, national and state organizations that provide education and support for preservation projects.

Secretary of the Interior's Standards for the Rehabilitation of Historic Properties

The Secretary of the Interior's Standards for the Rehabilitation of Historic Buildings are general rehabilitation guidelines established by the National Park Service. These standards are policies that serve as a basis for the design principles presented in the *Design Standards for Historic Properties*. The Secretary's Standards state that:

1. A property shall be used for its historic purpose or be placed in a new use that requires minimal change to the defining characteristics of the building and its site and environment.
2. The historic character of a property shall be retained and preserved. The removal of historic materials or alteration of features and spaces that characterize a property shall be avoided.
3. Each property shall be recognized as a physical record of its time, place, and use. Changes that create a false sense of historical development, such as adding conjectural features or architectural elements from other buildings, shall not be undertaken.
4. Most properties change over time; those changes that have acquired historic significance in their own right shall be retained and preserved.
5. Distinctive features, finishes, and construction techniques or examples of craftsmanship that characterize a historic property shall be preserved.
6. Deteriorated historic features shall be repaired rather than replaced. Where the severity of deterioration requires replacement of a distinctive feature, the new feature shall match the old in design, color, texture, and other visual qualities and, where possible, materials. Replacement of missing features shall be substantiated by documentary, physical, or pictorial evidence.
7. Chemical or physical treatments, such as sandblasting, that cause damage to historic materials shall not be used. The surface cleaning of structures, if appropriate, shall be undertaken using the gentlest means possible.
8. Significant archeological resources affected by a project shall be protected and preserved. If such resources must be disturbed, mitigation measures shall be undertaken.
9. New additions, exterior alterations, or related new construction shall not destroy historic materials that characterize the property. The new work shall be differentiated from the old and shall be compatible with the massing, size, scale, and architectural features to protect the historic integrity of the property and its environment.
10. New additions and adjacent or related new construction shall be undertaken in such a manner that if removed in the future, the essential form and integrity of the historic property and its environment would be unimpaired.

Preservation Resources in Galveston

NEIGHBORHOOD AND PRESERVATION ORGANIZATIONS

Galveston Historical Foundation (GHF), 502 20th Street, <http://www.galvestonhistory.org/>

The Foundation is a private, non-profit organization with open membership. GHF played a major role in getting the historic preservation ordinances of Galveston adopted. The preservation department or PCS program provides free advice regarding rehabilitation, financing, and maintenance of older homes. The foundation also maintains the Preservation Resource Center, an extensive library with information about the technical as well as research aspects of rehabilitation. GHF also has a Salvage Warehouse at 908 23rd Street, where old building materials are kept for reuse in Galveston.

Local Galveston Neighborhood Associations. These groups consist primarily of residents of the historic districts. Membership provides access to a network of information and services within each organization. The groups also periodically organize public activities for the residents of these neighborhoods to encourage a spirit of community.

East End Historic District Association, PO Box 2424, Galveston, Texas 77553

Silk Stocking Historic District Association, PO Box 2531, Galveston, Texas 77553

Lost Bayou Historic District, c/o San Jacinto

Neighborhood Association, 2209 Ave. K., Galveston, Texas 77550

GAIN (Galveston Alliance of Island Neighborhoods), c/o Bill Broussard

Rosenberg Library, Galveston and Texas History Center 2310 Sealy (Sealy @ 23rd Street). <http://www.rosenberg-library.org/>

The Archives has several collections of old photographs and manuscripts that may be used for documentation of specific houses or general types of houses. The library also holds several circulating copies of general histories of Galveston as well as many of the books included in the bibliography, which follows this section of the Design Standards.

CITY OF GALVESTON AGENCIES

Department of Planning and Community Development/Historic Preservation and Neighborhood Planning Division, City Hall, 823 Rosenberg.

This department is responsible for development planning and the enforcement of the Zoning Standards and subdivision regulations. Staffing is provided to the following boards and commissions: Planning Commission; Landmark Commission; Zoning Board of Adjustment; and City Council.

Building Division. This division administers all building permit applications, enforces building codes and issues certificates of occupancy for new construction and land uses.

Department of Public Works, 402 30th Street. Water, sewer and garbage services are handled by this office.

Division of Engineering, within the Dept. of Public Works, City Hall, 823 Rosenberg. The design of streets, drainage, surveying and engineering plans are the responsibility of this department.

State Preservation Resources

Texas Historical Commission, PO Box 12276, Austin, Texas, 78711-2276, <http://www.thc.state.tx.us/>

The Texas Historical Commission is the official state agency for historic preservation. A bimonthly newsletter, *The Medallion*, covers statewide preservation activities in addition to national policy. The Commission administers the state program of the National Register of Historic Places. This includes Grants-in-Aid and also certification of historic districts and properties, as required for tax benefits. The Commission is also responsible for placing all Recorded Texas Historic Landmark (RTHL) and building medallions.

Preservation Texas, PO Box 12832, Austin, TX 78711, Phone: 512.472.0102, FAX: 512.472.0740, info@preservationtexas.org

Preservation Texas is the only private, nonprofit membership organization in Texas that is dedicated to being a full-service statewide preservation organization. As a Statewide Partner with the National Trust for Historic Preservation, the organization is expanding its preservation activities. Preservation Texas was founded in 1985 by a group of volunteers concerned with the preservation of the built environment in Texas. Today, Preservation Texas has a twenty-one member Board of Directors and two full-time staff members. Members include individuals, government agencies, local nonprofit organizations and other groups concerned with preserving Texas' built environment and historic sites and resources.

National Preservation Resources

National Trust for Historic Preservation (NTHP), 1785 Massachusetts Avenue, N.W., Washington, D.C. 20036, <http://www.nationaltrust.org/>

U.S. Department of the Interior, National Park Service, Technical Preservation Services Division, Washington, D.C. 20240. <http://www2.cr.nps.gov/tps/>

Preservation Action, 1722 Connecticut Avenue, N.W., Washington, D.C. 20009, <http://www.preservationaction.org/>

Preservation-Related Publications

A series of helpful publications addressing preservation issues are listed below. Many of the listed publications are available at the Rosenberg Library or at the library of the Galveston Historical Foundation.

Barnstone, Howard. *The Galveston That Was*. Houston: The Museum of Fine Arts, Houston, 1966, 1993.

Beasley, Ellen. *Architectural-Historical Survey*, Galveston, Texas. Prepared for the Galveston Historical Foundation and the City of Galveston, 1977.

Beasley, Ellen and Stephen Fox. *Galveston Architectural Guide*. Rice University Press: 1996.

Beasley, Ellen. *The Alleys and Back Buildings of Galveston: An Architectural and Social History*. Houston: Rice University Press 1997.

- Blumenson, John J. G., *Identifying American Architecture: A Pictorial Guide to Styles and Terms 1600-1945*. New York: W. W. Norton & Company, 1977, 1981.
- Bucher, Ward, ed. *Dictionary of Building Preservation*. New York: John Wiley & Sons, Inc, 1996.
- Fitch, James Marston. *Historic Preservation: Curatorial Management of the Built World*. New York: McGraw-Hill, 1982.
- Galveston Historical Foundation, *Annual Homes Tour* catalogues, various dates, available at Heritage Visitor's Center, Ashton Villa, 23rd and Broadway.
- McAlester, Virginia and Lee. *A Field Guide to American Houses*. New York: Knopf, 1993.
- McComb, Davis G. *Galveston: A History*. Austin: University of Texas Press, 1986, 1993.
- Murtagh, William. 1988. *Keeping Time: The History and Theory of Preservation in America*. Pittstown, NY: Main Street Press.
- National Trust for Historic Preservation. *Past Meets Future: Saving America's Historic Environments*. Washington, D.C.: Preservation Press, 1992.
- Old House Journal*. 1972 to present (a monthly publication with technical advice for rehabilitation). Subscriptions available from the Old House Journal, Dept. 7, 69A Seventh Avenue, Brooklyn, N.Y. 11217.
- Parker, Patricia. *What is the National Historic Preservation Act?* Washington, D.C.: National Park Service, 1987.
- Preservation Briefs*. Technical Preservation Services Division-Heritage Conservation and Recreation Service. Washington, D.C.: U.S. Government Printing Office, 1975-1979. Available on line: <http://www2.cr.nps.gov/tps/briefs/presbhom.htm>
- Saylor, Henry H. *Dictionary of Architecture*. New York: John Wiley & Sons, Inc., 1952.
- Scardino, Barrie and Drexel Turner. *Clayton's Galveston: The Architecture of Nicholas J. Clayton and His Contemporaries*. College Station: Texas A&M Press, 2000.
- Stephen, George. *Remodeling Old Houses*. Washington, D.C.: Preservation Press of the National Trust, 1976.
- Stipe, Robert E. and Antoinette J. Lee. 1987. *The American Mosaic: Preserving A Nation's Heritage*. Washington, D.C.: US/ICOMOS.
- Upton, Dell. 1986. *America's Architectural Roots: Ethnic Groups That Build America*. Washington, D.C.: Preservation Press.
- Whelchel, Harriet, ed. *Caring for Your Historic House*. New York: Harry N. Abrams, Inc., 1998.
- Whiffen, Marcus. *American Architecture Since 1780: A Guide to the Styles*. Cambridge: The M.I.T. Press, 1969.

APPENDIX IV. DESIGNATION AND APPLICATION PROCESS

The general design review process and use of the *Design Standards for Historic Properties* is described in Chapter 1. Additional supporting information on the designation of historic resources and design review/permitting process is provided below.

Process for Individual Landmark Designation

For the Landmark Commission to consider a locally designated landmark the following criteria must be met:

11. A structure, object, site or building being considered for designation as a historic landmark must be at least 50 years old.
12. Possess character, interest, or value as part of the development, heritage, or cultural characteristics of the City of Galveston, Galveston County, the State of Texas, or the United States;
13. Recognition as a Recorded Texas Historic Landmark, National Historic Landmark, or entered into the National Register of Historic Places;
14. Association with events that have made significant contribution to the broad patterns of local, regional, state or national history;
15. Association with the lives of people significant in the city, region, state or national past;
16. Distinctive characteristics of a period or method of construction or architecture; representative of the work of a master designer; builder or craftsman; and,
17. Representative of an established and familiar visual feature of a neighborhood, community or city.

STEPS FOR APPROVAL OF LOCAL LANDMARK DESIGNATION

18. Applications to the Landmark Commission and Planning Commission must be submitted to the Division of Planning in accordance with the deadline date (typically 28 days prior to the scheduled hearing). All required supporting materials must accompany the application. The scheduled meeting dates of the Landmark and Planning Commissions are published each year by the Planning Division staff and are available on the City of Galveston web site.
19. The Landmark Commission meets a minimum of once each month, in a public hearing forum. Applicants should be prepared to answer any questions regarding the request. The Landmark Commission will forward a recommendation regarding the designation to the Galveston Planning Commission.
20. The Galveston Planning Commission meets twice a month in a public hearing forum. Applicants should be prepared to answer any questions regarding the request. The Planning Commission will forward a recommendation, regarding the designation, to the City Council
21. The City Council meets twice a month in a public hearing forum. Applicants should be prepared to answer any questions the Council may have regarding the request. The City Council has the final decision regarding the landmark designation.

Permitting and Appeals Process

The flow chart below supplements Chart 1.2: Application Process on page 15 with additional information on the permitting and appeals process for projects involving locally-designated historic resources.

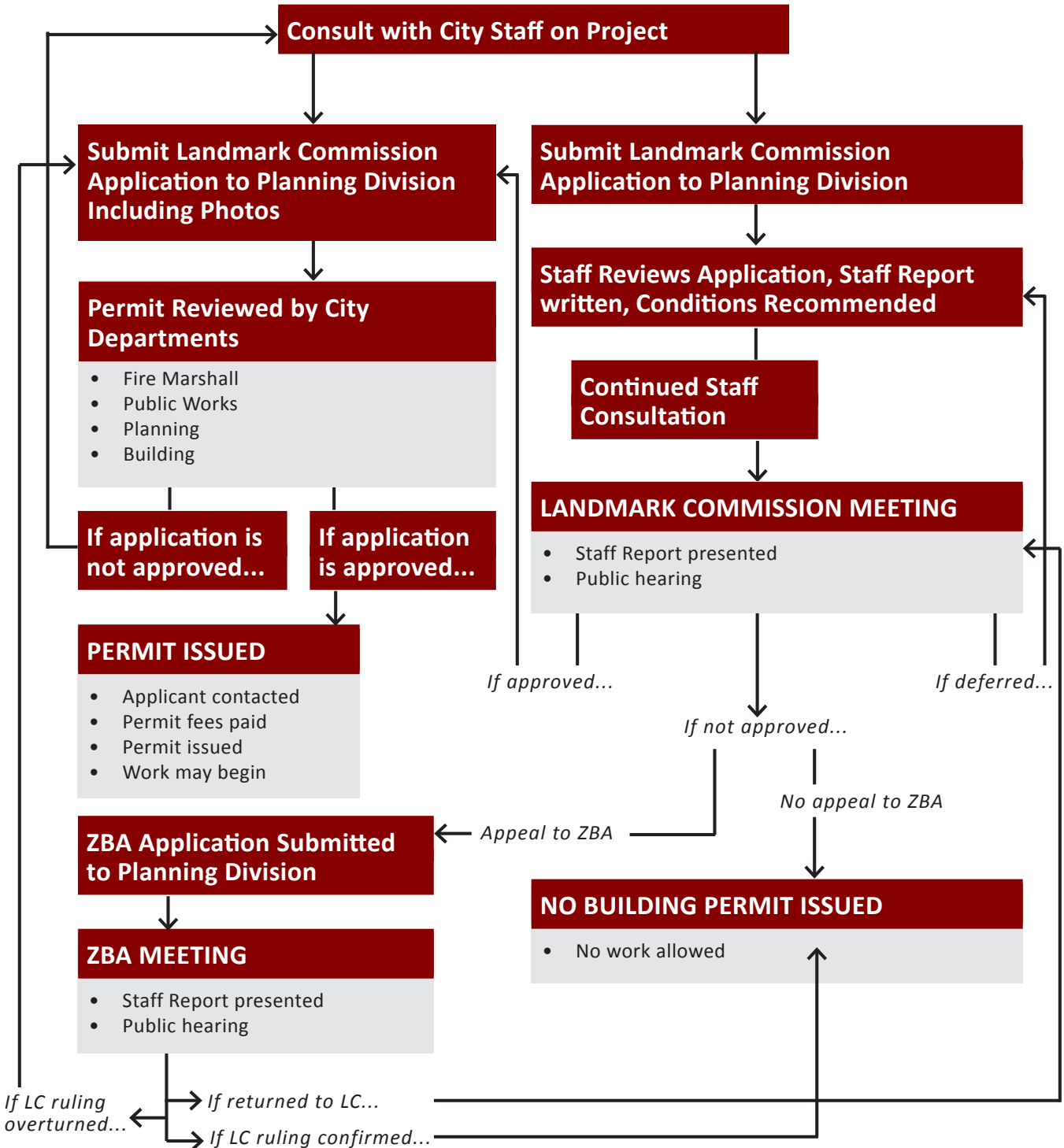

How to Present to the Landmark Commission

During the planning of the project, an applicant should research the history of the house and the neighborhood through various methods. Rosenberg Library's Galveston and Texas History Center maintains City of Galveston Sanborn Insurance Maps, tax records, phone books and historic photographs. The Galveston Historical Foundation's Preservation Resource Center also provides historic property research, neighborhood information, and technical rehabilitation information. All of these are valuable tools to uncovering the evolution of a property and planning a rehabilitation or restoration project.

The applicant should submit all documentation that supports the proposed alterations to the property with the Landmark Commission application. The information submitted will be used to evaluate the project in conformance with the City of Galveston Design Standards and to generate the Staff Report. Any information received after the submittal of the Landmark Commission application could cause delays in the generation of the staff report or the Commission's review, which can lead to a deferral request by Staff.

An applicant is encouraged to attend the Landmark Commission meeting to answer any questions the commission may have. However, if the applicant is unable to attend, a designated representative that understands the full scope of the project may answer questions from the commission. A formal presentation of the request is not required.



The 1872 Tremont Hotel at the corner of Post Office and Tremont (demolished in 1928)

Appendix V. Approved Paint Palettes

The following paint palettes have been approved for use in the historic districts:

Strand/Mechanic Historic District: “Victorian” palette by Sherwin-Williams. Please see the Exterior Color section on page 114 for more information on exterior painting projects.

All Historic Districts: The following colors are the approved palette for items in the right-of-way such as cell nodes and associated ground equipment:

- Rookwood Dark Brown, SW 2808;
- Rookwood Medium Brown, SW 2807;
- Rookwood Shutter Green, SW 2809; and
- Black.

All paint shall be a satin or flat finish.

The paint palettes do not apply to structures located within the residential historic districts.

Please note that use of Sherwin-Williams paint is not required. Any paint company may be used provided the color is matched to the approved palette.

Appendix V. Design Standards for Historic Properties Amendments

Section 4.14 Street Furniture, Page 105. Approved by Landmark Commission on May 21, 2012 (12PA-32):

- Insert 'Street furniture painted with a matte black finish may be administratively approved by Staff. Any other finish must be reviewed by the Landmark Commission on a case-by-case basis.' In the *Appropriate* section.

New Sidebar, Administrative Approval for Roofs, Page 76. Approved by Landmark Commission on May 21, 2012 (12PA-32):

A roof replacement may be administratively approved if:

- There is no change in roofing material;
- An asbestos shingle roof is being replaced with a composition shingle roof; or
- A metal tile roof is being replaced with metal tile or standing seam metal roofing.

New Sidebar, Design Standards for New Commercial Construction and Additions, Pages 121-132. Approved by Landmark Commission on May 20, 2013 (13PA-26):

- Add reference to the U.S. Department of the Interior's technical paper on 'Protecting a Historic Structure during Adjacent Construction'.

Chart 1.3 and 'Options for Board and Batten Foundation Skirting Sidebar, Board and Batten, Page 17 and 81. Approved by Landmark Commission on April 7, 2014 (14PA-14):

- Modify wording to provide a range of 12-16 inches on center for applied battens.

Section 3.6, Fencing, Page 73. Approved by Landmark Commission on October 20, 2014 (14PA-63):

- Insert 'Do not install vinyl fencing' in the *Inappropriate* section

Section 3.35, Building Materials, Page 94. Approved by Landmark Commission on October 20, 2014 (14PA-63):

- Insert 'When using cementitious fiber board, use the Artisan product line by the James Hardie Company, or similar product.' in the *Appropriate* section.

Various Sections. Approved by Landmark Commission on September 19, 2016 (16PA-047):

Sidewalk Amenities and Street Furniture, add new section:

4.16 Place Merchandise Displays so as not to detract from the historic buildings

Appropriate

- Place all merchandise displays within the building interior.

Commercial Building Standards, Historic Commercial Facades, add new section and renumber as needed:

4.22 Maintain historic commercial facades

Elements of commercial facades are to be kept free of dirt, grime, rust, old tape, and outdated notices and damaged or torn signage and decals. Do not penetrate masonry with any anchor or affix any device to cast iron elements without approval from the Landmark Commission.

4.35 – Sign Installation on a Historic Building

Add under Inappropriate:

- Do not block the threshold of doorways with signage.
- Do not install signage on doors.

4.39 – Where necessary, use a compatible, shielded light source to illuminate a sign.

Add under Inappropriate:

- Do not attach lights to the sign or sign structure, with the exception of properly shielded lights that are indented to illuminate a sign.

Page 120 – Sandwich Board and Temporary Signs

Modify text to reflect discussion of limiting sandwich board signs to one per entrance or one per business.

Page 148 – Sidebar

- Remove reference to PVC composite.
- Relocate sidebar to “Commercial Signage Standards” section.

Chart 1.3, Guide for Administrative Approval, Page 17. Approved by the Landmark Commission on November 7, 2016 (16PA-054):

- Clarify that lattice must be open - Is solid cedar not exceeding 6’ in height with an additional 2’ of framed open wooden lattice for a total height of up to 8’.

Appendix V. Approved Paint Palettes, Page A-28. Approved by the Landmark Commission on August 21, 2017 (17PA-042).

Chart 1.3, Guide for Administrative Approval, Page 17. Approved by the Landmark Commission on May 20, 2019 (19PA-016):

Item	Material	Administrative Approval?	Commission Review?	Comments
Elevation of structures		Yes	If exceeding the Base Flood Elevation and Freeboard requirements	Skirting and stair configuration must conform to the Design Standards

Chapter 5, Page 150. Design Standards for the Star State Company No. 3 Fire Station, 2828 Market. Approved by the Landmark Commission on March 7, 2022. (22PA-001)