



## 112 Magnolia Reserve Loop

### Upgrades

- Garage Epoxy coated flooring
- Kitchen Aid Dishwasher
- Whole House Generator
- EV Charger
- Driveway Expansion joints epoxy coating

### Date installed

December 2023  
January 2024  
March 2024  
December 2023  
April 2024

### Cost

\$3,500  
\$1,400  
\$29,148  
\$1,890  
\$2,400

---

**Total upgrades \$38,338**



There are different types and sizes  
of houses in our communities



People from  
around the world build their  
homes differently, depending  
on the climate where they live



A house protects us from  
heat, rain, cold and snow

Many years ago people  
used to live in caves



Then people started living  
in huts made of branches  
and tree leaves

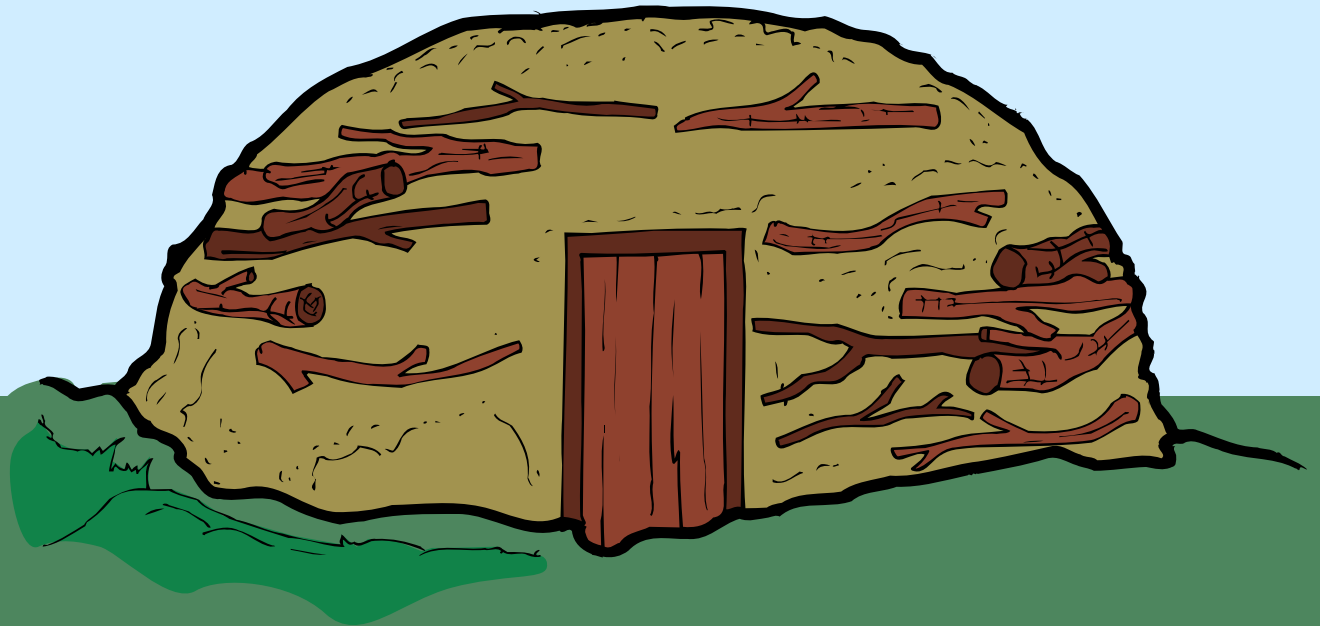



But huts didn't  
protect people  
from heavy rain

So they made houses with



stone

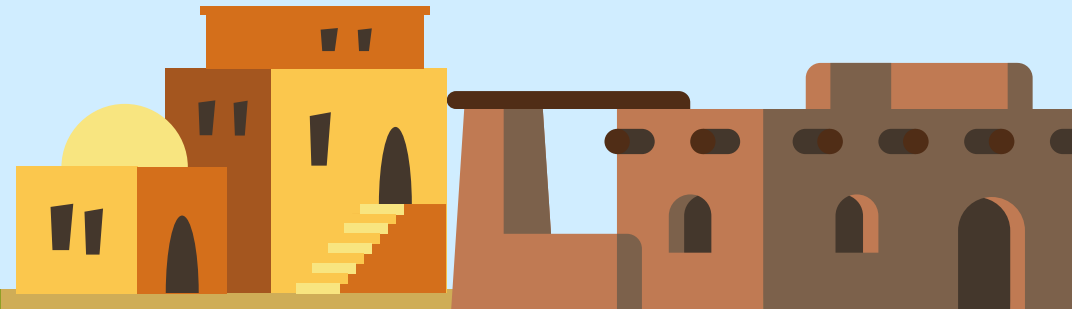

and mud



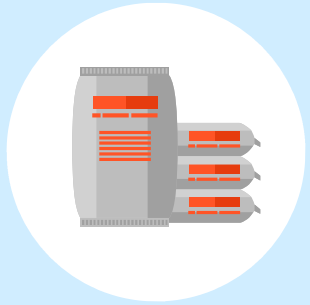

Nowadays people build houses with concrete

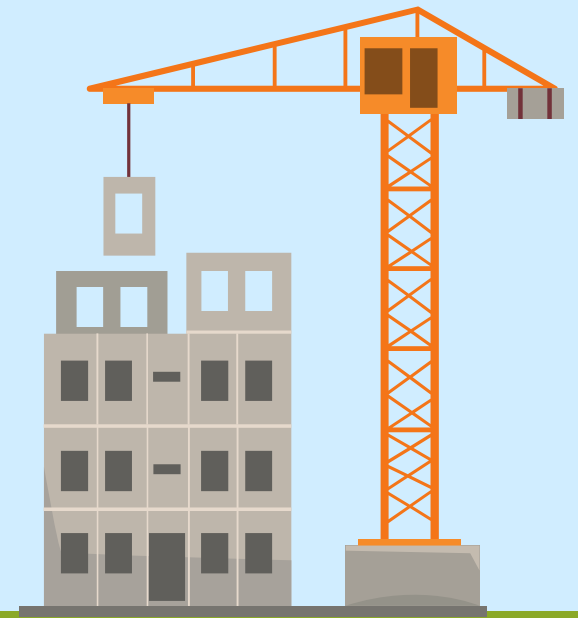
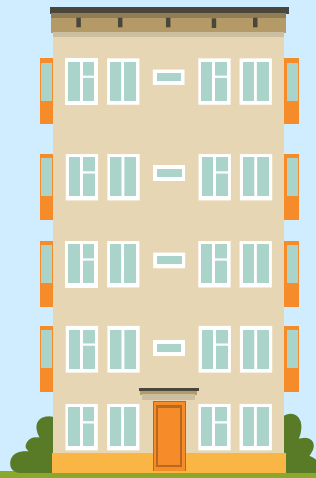

They are much stronger

Some other materials  
we can use to build houses are:  
wood, bricks, iron, steel and glass

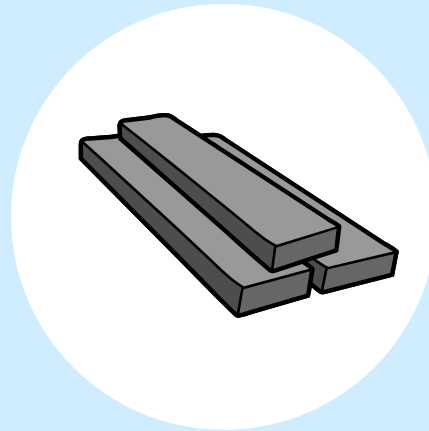
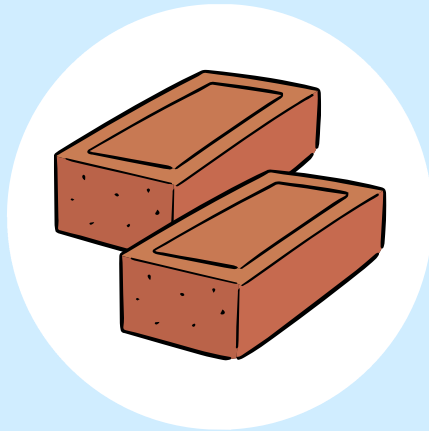
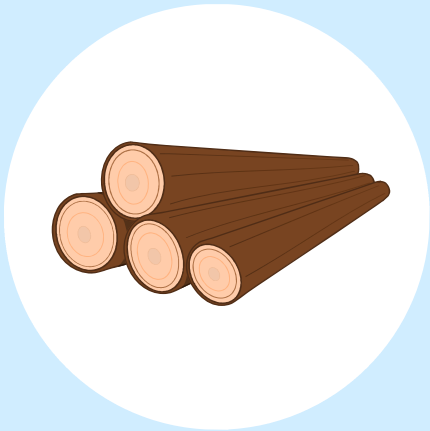



Some of the  
community helpers  
who help us  
build a house are:

**architects,  
plumbers,  
carpenters,  
builders,  
and electricians**





*What is your home like?*